

**STP 8-68W13-SM-TG**

**3 May 2013**

# **SOLDIER'S MANUAL AND TRAINER'S GUIDE**

**MOS 68W  
HEALTH  
CARE  
SPECIALIST**

**SKILL LEVELS 1/2/3**



**HEADQUARTERS, DEPARTMENT OF THE ARMY**

**DISTRIBUTION RESTRICTION:** Distribution authorized to US Government agencies and their contractors only to protect technical and operational information from automatic dissemination under the International Exchange Program or by other means. This determination was made on 12 September 2011. Other requests for this documentation will be referred to MCCS-IN, 3630 Stanley Rd Ste 101 Ft Sam Houston, TX 78234-6100.

**DESTRUCTION NOTICE:** Destroy by any approved method, i.e., shredding, pulping, or pulverizing, that will prevent disclosure of contents or reconstruction of this document..

This publication is available at Army Knowledge Online  
(<https://armypubs.us.army.mil/doctrine/index.html>).

To receive publishing updates, please subscribe at  
[http://www.apd.army.mil/AdminPubs/new\\_subscribe.asp](http://www.apd.army.mil/AdminPubs/new_subscribe.asp).

# SOLDIER's MANUAL and TRAINER'S GUIDE

## MOS 68W Health Care Specialist Skill Levels 1, 2 and 3

### TABLE OF CONTENTS

	<i>PAGE</i>
<b>Table of Contents</b> .....	i
<b>Preface</b> .....	v
<b>Chapter 1. Introduction</b> .....	1-1
1-1. General .....	1-1
1-2. Training Requirement. ....	1-1
1-3. Battle-Focused Training.....	1-6
1-4. Task Summary Format .....	1-7
1-5. Training Execution .....	1-8
1-6. Training Assessment .....	1-10
1-7. Training Support .....	1-11
<b>Chapter 2. Training Guide</b> .....	2-1
2-1. General .....	2-1
2-2. Subject Area Codes .....	2-2
2-3. Position Training Requirements.....	2-3
2-4. Critical Tasks List.....	2-4

---

**DISTRIBUTION RESTRICTION:** Distribution authorized to US Government agencies and their contractors only to protect technical and operational information from automatic dissemination under the International Exchange Program or by other means. This determination was made on 12 September 2011. Other requests for this documentation will be referred to MCCS-IN, 3630 Stanley Rd Ste 101 Ft Sam Houston, TX 78234-6100.

**DESTRUCTION NOTICE:** Destroy by any method that will prevent disclosure of contents or reconstruction of the document.

<sup>1</sup>This publication supersedes STP 8-68W13-SM-TG, 15 April 2009.

**CHAPTER 3 MOS/Skill Level Tasks.....3-1****Skill Level 1****Subject Area 1: Vital Signs (SL1)**

081-831-0010 Measure a Patient's Respirations.....	3-1
081-831-0011 Measure a Patient's Pulse.....	3-3
081-831-0012 Measure a Patient's Blood Pressure .....	3-5
081-831-0013 Measure a Patient's Temperature .....	3-8
081-831-0164 Measure a Patient's Oxygen Saturation .....	3-11

**Subject Area 2: Medical Treatment (SL1)**

081-833-0008 Initiate Treatment for a Respiratory Emergency.....	3-13
081-833-0001 Initiate a Tactical Combat Casualty Care (TCCC) Card .....	3-15
081-833-0116 Assist in Vaginal Delivery .....	3-17
081-833-0004 Initiate Treatment for a Poisoned Casualty .....	3-19
081-833-0010 Change a Sterile Dressing.....	3-23
081-831-0033 Initiate a Field Medical Card .....	3-27
081-833-0003 Initiate Treatment for Anaphylactic Shock .....	3-30
081-831-0046 Administer External Chest Compressions .....	3-32
081-833-0035 Initiate Treatment for High Altitude Illness.....	3-36
081-833-0005 Initiate Treatment for a Diabetic Emergency .....	3-39
081-833-0156 Perform A Medical Patient Assessment .....	3-41
081-833-0009 Initiate Treatment for a Near Drowning Casualty .....	3-46
081-833-0013 Initiate Treatment for an Allergic Reaction .....	3-48
081-833-0014 Operate an Automated External Defibrillator.....	3-50
081-831-0008 Put on Sterile Gloves.....	3-53
081-833-0002 Manage a Seizing Patient.....	3-55
081-833-0011 Initiate Treatment for Chest Pain.....	3-58

**Subject Area 3: Trauma Treatment (SL1)**

081-833-0065 Apply a Combat Application Tourniquet (C-A-T) .....	3-61
081-833-0068 Bandage an Open Wound .....	3-63
081-833-0047 Initiate Treatment for Hypovolemic Shock.....	3-66
081-833-0030 Initiate Treatment for an Open Chest Injury .....	3-68
081-833-0044 Initiate Treatment for Chemical Burns of the Eye.....	3-70
081-833-0063 Initiate Treatment for a Soft Tissue Injury.....	3-72
081-833-0075 Perform a Needle Chest Decompression .....	3-74
081-833-0078 Initiate Treatment for a Closed Chest Injury .....	3-76
081-833-0061 Initiate Treatment for an Amputation .....	3-79
081-833-0069 Apply an Occlusive Dressing.....	3-81
081-833-0096 Perform Extrication Using a Seated Device .....	3-83
081-833-0081 Initiate Treatment for Inguinal Wounds.....	3-86
081-833-0091 Initiate Treatment for Neck Wounds.....	3-88

081-833-0124 Control Bleeding .....	3-90
081-833-0079 Initiate Treatment for Axillary Wounds.....	3-92
081-833-0028 Initiate Treatment for an Open Abdominal Wound .....	3-94
081-833-0029 Initiate Treatment for an Impaled Object .....	3-96
081-833-0038 Initiate Treatment for a Head Injury .....	3-98
081-833-0039 Initiate Treatment for Foreign Bodies of the Eye .....	3-102
081-833-0040 Initiate Treatment for Lacerations of the Eyelid .....	3-105
081-833-0042 Initiate Treatment for Extrusions of the Eye .....	3-107
081-833-0051 Initiate Treatment for Burns .....	3-109
081-833-0053 Perform an EMT-B Trauma Assessment.....	3-115
081-833-0066 Apply an Improvised Tourniquet.....	3-121
081-833-0211 Apply a Hemostatic Dressing .....	3-123
081-833-0212 Apply a Pressure Dressing to an Open Wound .....	3-125
081-833-0067 Perform a Combat Casualty Assessment.....	3-127
081-833-0177 Apply a Cervical Collar .....	3-131
081-833-0181 Apply a Long Spine Board.....	3-133

#### **Subject Area 4: Airway Management (SL1)**

081-833-0098 Set Up an Oxygen Tank .....	3-136
081-833-0169 Insert a Combitube®.....	3-141
081-833-0142 Insert a Nasopharyngeal Airway.....	3-143
081-833-0170 Perform Endotracheal Suctioning .....	3-145
081-831-0018 Open the Airway .....	3-148
081-831-0019 Clear an Upper Airway Obstruction .....	3-150
081-831-0048 Perform Rescue Breathing .....	3-152
081-833-0016 Insert an Oropharyngeal Airway (J Tube).....	3-156
081-833-0017 Ventilate A Patient with a Bag-Valve-Mask System .....	3-158
081-833-0099 Perform Oral Suctioning .....	3-161
081-833-0158 Administer Oxygen .....	3-165
081-833-0230 Insert a King LT .....	3-169
081-833-3005 Perform a Surgical Cricothyroidotomy.....	3-172

#### **Subject Area 5: Venipuncture and IV Therapy (SL1)**

081-833-0101 Obtain a Blood Specimen .....	3-174
081-833-0033 Initiate an Intravenous Infusion.....	3-179
081-833-0034 Manage an Intravenous Infusion .....	3-185
081-833-0185 Initiate a FAST 1 .....	3-191
081-835-3025 Initiate a Saline Lock .....	3-193
081-833-0235 Discontinue an Intravenous Infusion .....	3-196

#### **Subject Area 6: Primary Care (SL1)**

081-833-0242 Provide Treatment for Sinus Infections .....	3-199
081-833-0254 Perform a HEENT Exam .....	3-201
081-833-0054 Irrigate Eyes .....	3-206

081-833-0240 Provide Treatment for Common Eye Infections.....3-209

081-833-0243 Provide Treatment for Common Throat Infections .....3-210

081-833-0245 Provide Care for Common Respiratory Disorders .....3-213

081-833-0246 Provide Treatment for a Behavioral Emergency.....3-216

081-833-0247 Perform a Military Acute Concussion Evaluation (MACE) Screening for  
Traumatic Brain Injury .....3-220

081-833-0241 Provide Treatment for Common Ear Infections .....3-224

081-833-0125 Treat Skin Disorders .....3-225

081-831-0007 Perform a Patient Care Handwash.....3-230

081-833-0145 Document Patient Care using Subjective, Objective, Assessment, Plan  
(SOAP) Note Format.....3-232

081-833-0239 Provide Treatment for Abdominal Disorders .....3-234

081-833-0193 Perform Visual Acuity Testing .....3-240

**Subject Area 7: Musculoskeletal (SL1)**

081-833-0263 Apply a Rigid Splint .....3-242

081-833-0264 Apply an Elastic Bandage.....3-246

081-833-0141 Apply a Traction Splint.....3-249

081-833-0269 Perform an Examination of the Shoulder.....3-252

081-833-0273 Perform an Examination of the Wrist.....3-254

081-833-0274 Perform an Examination of the Hip.....3-256

081-833-0265 Apply a Sling and Swath.....3-258

081-833-0267 Provide Care for a Casualty with a Suspected Spinal Injury .....3-260

081-833-0268 Perform an Examination of the Knee.....3-265

081-833-0272 Perform an Examination of the Ankle .....3-267

081-833-0266 Immobilize the Pelvis .....3-269

081-833-0270 Perform an Examination of the Elbow .....3-273

081-833-0271 Perform an Examination of the Back .....3-275

081-833-0222 Treat Common Musculoskeletal Disorders.....3-277

**Subject Area 8: CBRN (SL1)**

081-833-0095 Decontaminate a Casualty .....3-283

081-833-0093 Set Up a Casualty Decontamination Station .....3-291

**Subject Area 9: Triage and Evacuation (SL1)**

081-833-0283 Initiate a 9-Line Medevac Request .....3-295

081-833-0214 Load Casualties onto a UH-60 Series Helicopter .....3-297

081-833-0282 Perform Manual Evacuation .....3-300

081-833-0152 Establish a Casualty Collection Point.....3-305

081-833-0284 Load Casualties Onto A Mine Resistant Heavily Armored Ground Ambulance  
(HAGA) 6X6 RG. 33L.....3-308

081-833-0291 Unload Casualties From a Mine Resistant Heavily Armored Ground Ambulance  
(HAGA) 6x6 RG.33L .....3-313

081-833-0299 Prepare a SKEDCO for Hoist Operations.....3-318

081-833-0294 Unload Casualties From a UH-60 Series Helicopter .....	3-321
081-833-0298 Transport a Casualty Using a Litter .....	3-323
081-833-0281 Triage Casualties.....	3-326

**Subject Area 10: Medication Administration (SL1)**

081-833-0088 Prepare an Injection for Administration .....	3-330
081-833-0301 Administer an Intramuscular Injection .....	3-335
081-833-0303 Administer an Intradermal Injection .....	3-339
081-833-0304 Administer Common Medications.....	3-342
081-833-0302 Administer a Subcutaneous Injection .....	3-348
081-833-0022 Administer Inhalation Medications.....	3-352

**Subject Area 11: Force Health Protection (SL1)**

081-831-9018 Implement Suicide Prevention Measures .....	3-356
081-831-0038 Initiate Treatment for a Heat Injury .....	3-357
081-833-0072 Treat a Casualty for Insect Bites or Stings .....	3-360
081-833-0073 Treat a Casualty for Snake Bite.....	3-365
081-831-0039 Treat a Casualty for a Cold Injury.....	3-368

**Skill Level 2**

**Subject Area12: Medical Treatment (SL2)**

081-833-0196 Remove a Toenail .....	3-372
081-833-0024 Initiate Treatment for a Paronychia .....	3-377
081-833-3017 Insert a Urinary Catheter .....	3-379
081-833-3022 Insert a Nasogastric Tube .....	3-384
081-833-0187 Insert an Orogastric Tube.....	3-388
081-833-3023 Remove a Nasogastric Tube .....	3-391
081-833-0167 Place a Patient on a Cardiac Monitor .....	3-393
081-833-0006 Measure a Patient's Intake and Output .....	3-396
081-835-3005 Perform a Gastric Lavage.....	3-399
081-833-0197 Remove a Urinary Catheter.....	3-403
081-835-3007 Obtain an Electrocardiogram.....	3-406
081-833-0012 Perform Wound Irrigation .....	3-414

**Subject Area 13: Trauma Treatment (SL2)**

081-833-0194 Prepare an Aid Bag .....	3-417
---------------------------------------	-------

**Subject Area 14: Venipuncture and IV Therapy (SL2)**

081-835-3002 Administer Medications By IV Piggyback .....	3-420
081-833-0102 Operate an IV Infusion Pump .....	3-423
081-833-0238 Remove a FAST 1 .....	3-425

**Subject Area 15: Primary Care (SL2)**

081-833-0244 Provide Treatment for a Subungal Hematoma .....	3-427
081-833-0257 Operate a Glucometer .....	3-430
081-833-0165 Perform Patient Hygiene .....	3-432
081-833-0248 Obtain a Throat Culture .....	3-437

081-833-0256 Test a Stool Sample ..... 3-439  
 081-833-0258 Apply Flouri-Strip to an Eye ..... 3-441  
 081-833-0059 Irrigate an Obstructed Ear ..... 3-443  
 081-833-0255 Utilize a Urine Test Strip ..... 3-446  
 081-833-0195 Remove a Patient's Ring ..... 3-448

**Subject Area 16: CBRN (SL2)**

081-833-0276 Provide Treatment for a Blood Agent (Hydrogen Cyanide) Casualty in  
 the Field ..... 3-450  
 081-833-0277 Provide Treatment for a Choking Agent Casualty in the Field ..... 3-452  
 081-833-0280 Provide Treatment for a Radiation Casualty ..... 3-454  
 081-833-0275 Provide Treatment for a Nerve Agent Casualty in the Field ..... 3-457  
 081-833-0278 Provide Treatment for a Blister Agent Casualty (Mustard, Lewisite, Phosgene  
 Oxime) in the Field ..... 3-461  
 081-833-0279 Provide Treatment for a Biological Exposed Casualty ..... 3-464

**Subject Area 17: Triage and Evacuation (SL2)**

081-833-0173 Load Casualties onto Nonstandard Vehicles, 5 Ton M-1085, M-1093, 2 1/2 Ton  
 M-1081 ..... 3-471  
 081-833-0171 Load Casualties onto Nonstandard Vehicles, 1 1/4 Ton, 4 x 4, M998 ..... 3-474  
 081-833-0287 Load Casualties Onto a CH-47 Series Helicopter ..... 3-476  
 081-833-0226 Load Casualties onto a Stryker Armored Ambulance ..... 3-479  
 081-833-0296 Unload Casualties From a Stryker Armored Ambulance ..... 3-482  
 071-334-4002 Establish a Helicopter Landing Point ..... 3-486  
 081-833-0295 Unload Casualties From a CH-47 Series Helicopter ..... 3-487  
 081-833-0172 Load Casualties onto Nonstandard Vehicles, 2 1/2 Ton, 6X6 or 5 Ton, 6X6,  
 Cargo Truck ..... 3-489  
 081-833-0289 Unload Casualties From Nonstandard Vehicles, 5 Ton M-1085, M-1093, 2 1/2  
 Ton M-1081 ..... 3-491  
 081-833-0290 Unload Casualties From Nonstandard Vehicles, 1 1/4 TON, 4 x 4, M998 ..... 3-493  
 081-833-0288 Unload Casualties From Nonstandard Vehicles, 2 1/2 Ton, 6X6 or 5 Ton, 6X6  
 Cargo Truck ..... 3-494  
 081-833-0184 Establish an Ambulance Exchange Point ..... 3-495

**Subject Area 18: Medication Administration(SL2)**

081-833-0020 Administer Ear Medications ..... 3-498  
 081-833-0015 Administer Eye Medications ..... 3-500  
 081-835-3020 Administer Topical Medications ..... 3-504

**Subject Area 19: Force Health Protection (SL2)**

081-831-0037 Disinfect Water for Drinking ..... 3-507  
 081-833-0076 Apply Restraining Devices to Patients ..... 3-509

**Skill Level 3**

**Subject Area 20: Medical Treatment (SL3)**

081-833-0036 Perform a Digital Block Anesthesia ..... 3-513  
 081-833-0026 Perform Suture Removal ..... 3-515



081-833-0007 Establish a Sterile Field .....	3-517
081-833-0027 Perform Staple Removal .....	3-519
081-833-0192 Perform Abscess Incision and Drainage .....	3-521
<b>Subject Area 21: Trauma Treatment (SL3)</b>	
081-833-0071 Suture a Laceration .....	3-524
081-833-0087 Prepare Suture Site .....	3-527
081-833-0090 Apply Local Anesthesia .....	3-530
<b>Subject Area 22: Airway Management (SL3)</b>	
081-833-0168 Insert a Chest Tube .....	3-532
081-833-0100 Insert an Endotracheal Tube .....	3-534
<b>Subject Area 23: Venipuncture and IV Therapy (SL3)</b>	
081-835-3000 Administer Blood .....	3-537
081-835-3054 Administer Blood Products .....	3-541
081-833-0236 Remove an EZ Intraosseous Device .....	3-543
081-833-0237 Initiate an EZ Intraosseous Device .....	3-545
<b>Subject Area 24: Triage and Evacuation (SL3)</b>	
081-833-0227 Coordinate Casualty Treatment and Evacuation .....	3-549
<b>Subject Area 25: Medication Administration (SL3)</b>	
081-833-0309 Administer Medication Through Endotracheal Tube .....	3-553
Glossary .....	Glossary
Reference .....	Reference

## PREFACE

This publication is for skill level 1, 2 and 3 Soldiers holding military occupational specialty (MOS) 68W and for trainers and first-line supervisors. It contains standardized training objectives, in the form of task summaries, to train and evaluate Soldiers on critical tasks that support unit missions during wartime. Trainers and first-line supervisors should ensure Soldiers holding MOS 68WSL1/SL2/SL3 have access to this publication. This STP is available for download from the Central Army Registry (CAR).

This publication applies to the Active Army, the Army National Guard (ARNG)/Army National Guard of the United States (ARNGUS), and the U.S. Army Reserve (USAR) unless otherwise stated.

The proponent of this publication is the United States Army Training and Doctrine Command (TRADOC). Send comments and recommendations on DA Form 2028 (*Recommended Changes to Publications and Blank Forms*) directly to Academy of Health Sciences, ATTN: MCCS-HC-CD, 2377 Greeley Road, STE T, Fort Sam Houston, TX 78234-5078.

Unless this manual states otherwise, masculine pronouns do not refer exclusively to men.

## CHAPTER 1

### Introduction

**1-1. General.** This Soldier training publication (STP) identifies the individual military occupational specialty (MOS) training requirements for Soldiers in MOS 68W. Another source of STP task data is the Central Army Registry (CAR) at the [Army Training \(and Education\) Network](#). Commanders, trainers, and Soldiers should use the STP to plan, conduct, and evaluate individual training in units. The STP is the primary MOS reference to support the self-development and training of every Soldier in the unit. It is used with the Soldier's Manual of Common Tasks, collective training products, and ADRP 7-0, Training Units and Developing Leaders, to establish effective training plans and programs that integrate Soldier, leader, and collective tasks. This chapter explains how to use the STP in establishing an effective individual training program. It includes doctrinal principles and implications outlined in ADRP 7-0. Based on these guidelines, commanders and unit trainers must tailor the information to meet the requirements for their specific unit.

**1-2. Training Requirement.** Every Soldier, noncommissioned officer (NCO), warrant officer, and officer has one primary mission — to be trained and ready to fight and win our nation's wars. Success in battle does not happen by accident; it is a direct result of tough, realistic, and challenging training.

a. Operational Environment.

(1) Commanders and leaders at all levels must conduct training with respect to a wide variety of operational missions across the full spectrum of operations. These operations may include combined arms, joint, multinational, and interagency considerations, and span the entire breadth of terrain and environmental possibilities. Commanders must strive to set the daily training conditions as closely as possible to those expected for actual operations.

(2) The operational missions of the Army include not only war, but also military operations other than war (MOOTW). Operations may be conducted as major combat operations, a small-scale contingency, or a peacetime military engagement. Offensive and defensive operations normally dominate military operations in war along with some small-scale contingencies. Stability operations and support operations dominate in MOOTW. Commanders at all echelons may combine different types of operations simultaneously and sequentially to accomplish missions in war and MOOTW. These missions require training since future conflict will likely involve a mix of combat and MOOTW, often concurrently. The range of possible missions complicates training. Army forces cannot train for every possible mission; they train for war and prepare for specific missions as time and circumstances permit.

(3) One type of MOOTW is the Chemical, Biological, Radiological, and Nuclear (CBRN) event. To assist commanders and leaders in training their units, CBRN-related information is being included in AMEDD collective training. Even though most collective tasks within an MTP may support a CBRN event, the ones that will most directly be impacted are clearly indicated with a statement in the CONDITION that reads: "THIS TASK MAY BE USED TO SUPPORT A CBRN EVENT." These collective tasks and any supporting individual tasks in this Soldier's manual should be considered for training emphasis.

(4) Our forces today use a train-alert-deploy sequence. We cannot count on the time or opportunity to correct or make up training deficiencies after deployment. Maintaining

forces that are ready now, places increased emphasis on training and the priority of training. This concept is a key link between operational and training doctrine.

(5) Units train to be ready for war based on the requirements of a precise and specific mission. In the process they develop a foundation of combat skills that can be refined based on the requirements of the assigned mission. Upon alert, commanders assess and refine from this foundation of skills. In the train-alert-deploy process, commanders use whatever time the alert cycle provides to continue refinement of mission-focused training. Training continues during time available between alert notification and deployment, between deployment and employment, and even during employment as units adapt to the specific battlefield environment and assimilate combat replacements.

b. How the Army Trains the Army.

(1) Training is a team effort and the entire Army — Department of the Army, major commands (MACOMs), the institutional training base, units, the combat training centers (CTCs), each individual Soldier, and the civilian workforce — has a role that contributes to force readiness. Department of the Army and MACOMs are responsible for resourcing the Army to train. The Institutional Army, including schools, training centers, and NCO academies, for example, train Soldiers and leaders to take their place in units in the Army by teaching the doctrine and tactics, techniques, and procedures (TTP). Units, leaders, and individuals train to standard on their assigned critical individual tasks. The unit trains first as an organic unit and then as an integrated component of a team. Before the unit can be trained to function as a team, each Soldier must be trained to perform their individual supporting tasks to standard. Operational deployments and major training opportunities, such as major training exercises, and CTCs provide rigorous, realistic, and stressful training and operational experience under actual or simulated combat and operational conditions to enhance unit readiness and produce bold, innovative leaders. The result of this Army-wide team effort is a training and leader development system that is unrivaled in the world. Effective training produces the force — Soldiers, leaders, and units — that can successfully execute any assigned mission.

(2) The Army Training and Leader Development Model (Refer to Figure 1-1.) centers on developing trained and ready units led by competent and confident leaders. The model depicts an important dynamic that creates a lifelong learning process. The three core domains that shape the critical learning experiences throughout a Soldier's and leader's time span are the operational, institutional, and self-development domains. Together, these domains interact using feedback and assessment from various sources and methods to maximize warfighting readiness. Each domain has specific, measurable actions that must occur to develop our leaders.

- The operational domain includes home station training, CTC rotations, and joint training exercises and deployments that satisfy national objectives. Each of these actions provides foundational experiences for Soldier, leader, and unit development.
- The institutional domain focuses on educating and training Soldiers and leaders on the key knowledge, skills, and attributes required to operate in any environment. It includes individual, unit and joint schools, and advanced education.

- The self-development domain, both structured and informal, focuses on taking those actions necessary to reduce or eliminate the gap between operational and institutional experiences.

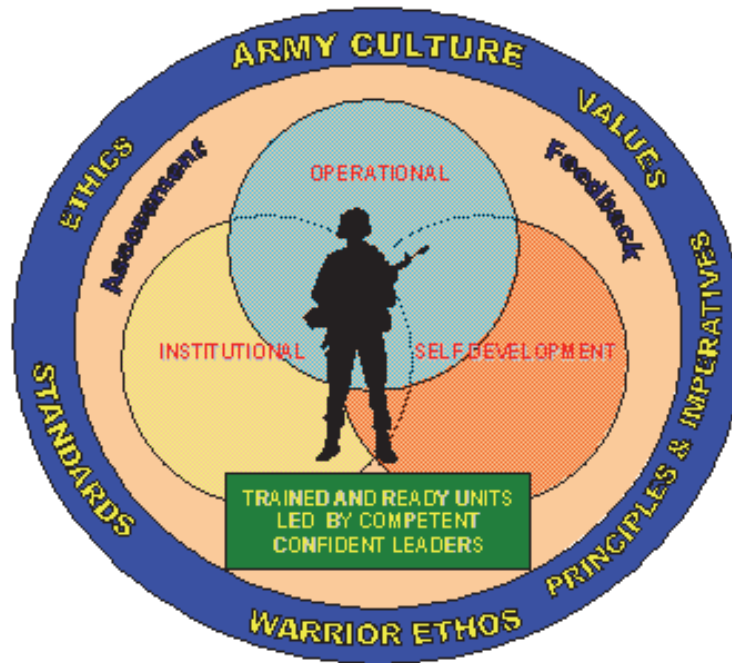

Figure 1-1. Army Training and Leader Development Model

(3) Throughout this lifelong learning and experience process, there is formal and informal assessment and feedback of performance to prepare leaders and Soldiers for their next level of responsibility. Assessment is the method used to determine the proficiency and potential of leaders against a known standard. Feedback must be clear, formative guidance directly related to the outcome of training events measured against standards.

c. Leader Training and Leader Development.

(1) Competent and confident leaders are a prerequisite to the successful training of units. It is important to understand that leader training and leader development are integral parts of unit readiness. Leaders are inherently Soldiers first and should be technically and tactically proficient in basic Soldier skills. They are also adaptive, capable of sensing their environment, adjusting the plan when appropriate, and properly applying the proficiency acquired through training.

(2) Leader training is an expansion of these skills that qualifies them to lead other Soldiers. As such, doctrine and principles of training require the same level of attention of senior commanders. Leader training occurs in the Institutional Army, the unit, the CTCs, and through self-development. Leader training is just one portion of leader development.

(3) Leader development is the deliberate, continuous, sequential, and progressive process, grounded in Army values, that grows Soldiers and civilians into competent and confident leaders capable of decisive action. Leader development is achieved through the life-

long synthesis of the knowledge, skills, and experiences gained through institutional training and education, organizational training, operational experience, and self-development. Commanders play the key role in leader development that ideally produces tactically and technically competent, confident, and adaptive leaders who act with boldness and initiative in dynamic, complex situations to execute mission-type orders achieving the commander's intent.

(4) The life cycle management diagram combined with the 68W MOS Training Plan forms the Soldiers career development model. This information, combined with the MOS Training Plan in Chapter 2, forms the career development model for the MOS.

d. Training Responsibility. Soldier and leader training and development continue in the unit. Using the institutional foundation, training in organizations and units focuses and hones individual and team skills and knowledge.

(1) Commander Responsibility.

(a) The unit commander is responsible for the wartime readiness of all elements in the formation. The commander is, therefore, the primary trainer of the organization and is responsible for ensuring that all training is conducted in accordance with the STP to the Army standard.

(b) Commanders ensure STP standards are met during all training. If a Soldier fails to meet established standards for identified MOS tasks, the Soldier must retrain until the tasks are performed to standard. Training to standard on MOS tasks is more important than completion of a unit training event. The objective is to focus on sustaining MOS proficiency — this is the critical factor commanders must adhere to when training individual Soldiers in units.

(2) NCO Responsibility.

(a) A great strength of the US Army is its professional NCO Corps who takes pride in being responsible for the individual training of Soldiers, crews, and small teams. The NCO support channel parallels and complements the chain of command. It is a channel of communication and supervision from the Command Sergeant Major (CSM) to the First Sergeants (1SG) and then to other NCOs and enlisted personnel. NCOs train Soldiers to the non-negotiable standards published in STPs. Commanders delegate authority to NCOs in the support channel as the primary trainers of individual, crew, and small team training. Commanders hold NCOs responsible for conducting standards-based, performance-oriented, battle-focused training and providing feedback on individual, crew, and team proficiency. Commanders define responsibilities and authority of their NCOs to their staffs and subordinates.

MOS 68W Health Care Specialist CAREER/TRAINING LIFE CYCLE										
RANK	AMEDD Course NR	TRAINING	LENGTH	LOCATION	ATTENDANCE REQUIREMENT	SELF-Development Course NR	SELF-DEVELOPMENT PROGRAM	LENGTH	LOCATION	ATTENDANCE REQUIREMENT
E1-E5	200-433000	Basic Combat Training Course	10 weeks	Ft. LW / Ft. SH / Ft. Jackson / Ft. Benning	IET		PROFESSIONAL POSTGRADUATE SHORT COURSE PROGRAM			
	200-433000	Health Care Specialist	16 weeks	FSH, TX	AIT/MOS	200-40702	Surgical Support MCO Short Course	4 days	SA, TX	Surtelement
	400-0010	SEE ASU M3, M3, P1, P2, P3, M3, M3, T6	3 weeks	Multiple sites	Leadership	240-4012	MEDCOM CSM/SGM/ASR MCO SHORT	5 days	SA, TX	Surtelement
	200-433000	Warrior Leader Course	4 weeks	USASMA	voluntary ASIF3	240-4074	CSM/SGM/MCO SHORT COURSE (EUROPE)	4 days	Multiple sites, Germany	Surtelement
	200-433000	Flight Medic	1 week DL	Onbase	voluntary ASIF3	44-200A0120	Joint Service Emergency Medicine Symposium	1 day	SA, TX	Surtelement
	200-433000	National Registry Paramedic (NRP) Certification	34 weeks	FSH, TX	voluntary ASIF2	44-200A0302	Advanced Field Medicine Short Course	3 days	FSH, TX	Surtelement
	200-433000	Special Operations Combat Medic Course	24 weeks	Fort Bragg, NC	voluntary ASIF3 to ASIF1	44-200A0304	Sparanadin, Pleur Operator, Intelligence, Trainable	5 days	FSH, TX	Surtelement
	200-433000	ALC COMMON CORE Phase 3	2 weeks	FSH, TX	DA Selection Leadership		DISTRIBUTED LEARNING (DL) / CORRESPONDENCE COURSES			
	200-433000	HEALTHCARE ALC (MTI) phase 2	1 week 1 day	FSH, TX	DA Selection Leadership		CBRN Operator / Responder Course		On-Line	Initial / 3 year reticulation requirement
	200-433000	AMEDD ADVANCED LEADER COURSE	3 weeks	FSH, TX	DA Selection Leadership		See page 3			
	200-433000	MCO ADVANCED LEADER COURSE (M)	8 weeks	FSH, TX	DA Selection Leadership		SPECIALTY COURSES			
	400-4010	MCO Basic ALC (Common Core) PA 1 (TATS)	2 days	Multiple sites	DA Selection Leadership	80-9502-510A1E	Orientation to the AMEDD Training Process	2 days	Ft Sam Houston	JIT
	80-9502-510A1E	TATS AMEDD ALC (Common Core) Phase 1 (DL)	1 week 3 days	Multiple sites	DA Selection Leadership		Air Assault School	2 weeks	Ft Campbell various sites	Once upon assignment to Air Assault position /
E4-E7	80-9502-510A1E	Instructor Training Course	4 days	FSH, TX	JIT/AS1 (SK)	24-5002-5001-5001-5001	Airborne Training	3 weeks	Ft Benning	Once upon assignment to Rickman Dir / Yalabakar
	80-9502-510A1E	Small Group Instructor Trainable Course (SSBIC)	1 week	FSH, TX	JIT		EMT-Intermediate		Various locations	
	200-433000	Battle Staff MCO Phase 1 (DL)	2 weeks, 1 day	Multiple sites	JIT AS1 25	200-433000	EMT-Paramedic	26 weeks	Ft. Sam Houston, TX	
	200-433000	Battle Staff MCO Phase 2 (Resident)	4 weeks, 2 days	Multiple sites	JIT AS1 25					
	501-501	Army Recruiter	6 weeks	USAREC	JIT S01 4					
	902-500	DRILL SERGEANT	9 weeks	Multiple sites	JIT S01-3					
		Instructor General MCO								
		Equal Opportunity Advisor								
		Resource Management Advisor								
		Observer/Controller DTG								
	43-004-100	AMEDD SENIOR LEADER	8 weeks	Various	MCOE					
	43-004-100	AMEDD SENIOR LEADER COURSE (SLO)	4 weeks, 2 days	FSH, TX	DA Selection Leadership					
	10-8-800	Medical Education and Demonstration of Individual Competence (MEDIC) (EMT)	Varies	Unit Training	Semi-Annual Re-certification (ASST/ASST/ASST)					
E8	52430100	FIRST SERGEANT	DL	USASMA	JIT S01-H					
E9	1420-05-100	U.S. ARMY SERGEANTS MAJOR (PA 1)	8 weeks	Direct Learning	DA Selection					
	1420-05	U.S. ARMY SERGEANTS MAJOR	41 weeks, 2 days	USASMA (ft. BIL)	DA Selection					
	1420-05	U.S. ARMY SERGEANTS MAJOR (PA 2)	2 weeks	USASMA (ft. Buz)	DA Selection					
	20-7224-01-100	BDE & BN PRE-CMD/SGM (O)	1 week	FT Leovannumb, FT Leovannumb	Leadership					
	20-7224-01-100	BDE & BN PRE-CMD/SGM	2 week	FT Leovannumb, FT Leovannumb	Leadership					

Figure 1-2. 68W Life Cycle Management Diagram

(b) NCOs continue the Soldierization process of newly assigned enlisted Soldiers, and begin their professional development. NCOs are responsible for conducting standards-based, performance-oriented, battle-focused training. They identify specific individual, crew, and small team tasks that support the unit's collective mission essential tasks; plan, prepare, rehearse, and execute training; and evaluate training and conduct after action reviews (AARs) to provide feedback to the commander on individual, crew, and small team proficiency. Senior NCOs coach junior NCOs to master a wide range of individual tasks.

(3) Soldier Responsibility. Each Soldier is responsible for performing individual tasks identified by the first-line supervisor based on the unit's mission essential task list (METL). Soldiers must perform tasks to the standards included in the task summary. If Soldiers have questions about tasks or which tasks in this manual they must perform, they are responsible for asking their first-line supervisor for clarification, assistance, and guidance. First-line supervisors know how to perform each task or can direct Soldiers to appropriate training materials, including current field manuals, technical manuals, and Army regulations. Soldiers are responsible for using these materials to maintain performance. They are also responsible for maintaining standard performance levels of all Soldier's Manual of Common Tasks at their current skill level and below. Periodically, Soldiers should ask their supervisor or another Soldier to check their performance to ensure that they can perform the tasks.

**1-3. Battle-Focused Training.** Battle focus is a concept used to derive peacetime training requirements from assigned and anticipated missions. The priority of training in units is to train to standard on the wartime mission. Battle focus guides the planning, preparation, execution, and assessment of each organization's training program to ensure its members train as they are going to fight. Battle focus is critical throughout the entire training process and is used by commanders to allocate resources for training based on wartime and operational mission requirements. Battle focus enables commanders and staffs at all echelons to structure a training program that copes with non-mission-related requirements while focusing on mission essential training activities. It is recognized that a unit cannot attain proficiency to standard on every task whether due to time or other resource constraints. However, unit commanders can achieve a successful training program by consciously focusing on a reduced number of METL tasks that are essential to mission accomplishment.

a. Linkage between METL and STP. A critical aspect of the battle focus concept is to understand the responsibility for and the linkage between the collective mission essential tasks and the individual tasks that support them. For example, the commander and the CSM/1SG must jointly coordinate the collective mission essential tasks and supporting individual tasks on which the unit will concentrate its efforts during a given period. This task hierarchy is provided in the task database at the Central Army Registry (CAR). The CSM/1SG must select the specific individual tasks that support each collective task to be trained. Although NCOs have the primary role in training and sustaining individual Soldier skills, officers at every echelon remain responsible for training to established standards during both individual and collective training. Battle focus is applied to all missions across the full spectrum of operations.

b. Relationship of STPs to Battle-focused Training. The two key components of any STP are the Soldier's manual (SM) and trainer's guide (TG). Each gives leaders important information to help implement the battle-focused training process. The trainer's guide relates Soldier and leader tasks in the MOS and skill level to duty positions and equipment. It states where the task is trained, how often training should occur to sustain proficiency, and who in the



unit should be trained. As leaders assess and plan training, they should rely on the trainer's guide to help identify training needs.

(1) Leaders conduct and evaluate training based on Army-wide training objectives and on the task standards published in the Soldier's manual task summaries or in the Central Army Registry. The task summaries ensure that --

- Trainers in every unit and location define task standards the same way.
- Trainers evaluate all Soldiers to the same standards.

(2) Figure 1-3 shows how battle-focused training relates to the trainer's guide and Soldier's manual:

- The left column shows the steps involved in training Soldiers.
- The right column shows how the STP supports each of these steps.

<b>BATTLE-FOCUS PROCESS</b>	<b>STP SUPPORT PROCESS</b>
Select supporting Soldier tasks	Use TG to relate tasks to METL
Conduct training assessment	Use TG to define what Soldier tasks to assess
Determine training objectives	Use TG to set objectives
Determine strategy; plan for training	Use TG to relate Soldier tasks to strategy
Conduct pre-execution checks	Use SM task summary as source for task performance
Execute training; conduct after action review	Use SM task summary as source for task performance
Evaluate training against established standards	Use SM task summary as standard for evaluation

Figure 1-3. Relationship of Battle-focused Training and STP

**1-4. Task Summary Format.** Task summaries outline the wartime performance requirements of each critical task in the SM. They provide the Soldier and the trainer with the information necessary to prepare, conduct, and evaluate critical task training. As a minimum, task summaries include information the Soldier must know and the skills that he must perform to standards for each task. The format of the task summaries included in this SM is as follows:

- a. **Task Title.** The task title identifies the action to be performed.
- b. **Task Number.** A 10-digit number identifies each task or skill. This task number, along with the task title, must be included in any correspondence pertaining to the task.
- c. **Conditions.** The task conditions identify all the equipment, tools, references, job aids, and supporting personnel that the Soldier needs to use to perform the task in wartime. This section identifies any environmental conditions that can alter task performance, such as visibility, temperature, or wind. This section also identifies any specific cues or events that trigger task performance, such as a chemical attack or identification of a threat vehicle.
- d. **Standards.** The task standards describe how well and to what level the task must be performed under wartime conditions. Standards are typically described in terms of accuracy, completeness, and speed.

e. Performance Steps. This section includes a detailed outline of information on how to perform the task. Additionally, some task summaries include safety statements and notes. Safety statements (danger, warning, and caution) alert users to the possibility of immediate death, personal injury, or damage to equipment. Notes provide a small, extra supportive explanation or hint relative to the performance steps.

f. Evaluation Preparation (when used). This subsection indicates necessary modifications to task performance in order to train and evaluate a task that cannot be trained to the wartime standard under wartime conditions. It may also include special training and evaluation preparation instructions to accommodate these modifications and any instructions that should be given to the Soldier before evaluation.

g. Performance Measures. This evaluation guide identifies the specific actions that the Soldier must do to successfully complete the task. These actions are listed in a GO/NO-GO format for easy evaluation. Each evaluation guide contains an evaluation guidance statement that indicates the requirements for receiving a GO on the evaluation.

h. References. This section identifies references that provide more detailed and thorough explanations of task performance requirements than those given in the task summary description.

**1-5. Training Execution.** All good training, regardless of the specific collective, leader, and individual tasks being executed, must comply with certain common requirements. These include adequate preparation, effective presentation and practice, and thorough evaluation. The execution of training includes preparation for training, conduct of training, and recovery from training.

a. Preparation for Training. Formal near-term planning for training culminates with the publication of the unit training schedule. Informal planning, detailed coordination, and preparation for executing the training continue until the training is performed. Commanders and other trainers use training meetings to assign responsibility for preparation of all scheduled training. Preparation for training includes selecting tasks to be trained, planning the conduct of the training, training the trainers, reconnaissance of the site, issuing the training execution plan, and conducting rehearsals and pre-execution checks. Pre-execution checks are preliminary actions commanders and trainers use to identify responsibility for these and other training support tasks. They are used to monitor preparation activities and to follow up to ensure planned training is conducted to standard. Pre-execution checks are a critical portion of any training meeting. During preparation for training, battalion and company commanders identify and eliminate potential training distracters that develop within their own organizations. They also stress personnel accountability to ensure maximum attendance at training.

(1) Subordinate leaders, as a result of the bottom-up feed from internal training meetings, identify and select the individual tasks necessary to support the identified training objectives. Commanders develop the tentative plan to include requirements for preparatory training, concurrent training, and training resources. At a minimum, the training plan should include confirmation of training areas and locations, training ammunition allocations, training simulations and simulators availability, transportation requirements, Soldier support items, a risk management analysis, assignment of responsibility for the training, designation of trainers responsible for approved training, and final coordination. The time and other necessary resources for retraining must also be an integral part of the original training plan.

(2) Leaders, trainers, and evaluators are identified, trained to standard, and rehearsed prior to the conduct of the training. Leaders and trainers are coached on how to train, given time to prepare, and rehearsed so that training will be challenging and doctrinally correct. Commanders ensure that trainers and evaluators are not only tactically and technically competent on their training tasks, but also understand how the training relates to the organization's METL. Properly prepared trainers, evaluators, and leaders project confidence and enthusiasm to those being trained. Trainer and leader training is a critical event in the preparation phase of training. These individuals must demonstrate proficiency on the selected tasks prior to the conduct of training.

(3) Commanders, with their subordinate leaders and trainers, conduct site reconnaissance, identify additional training support requirements, and refine and issue the training execution plan. The training plan should identify all those elements necessary to ensure the conduct of training to standard. Rehearsals are essential to the execution of good training. Realistic, standards-based, performance-oriented training requires rehearsals for trainers, support personnel, and evaluators. Preparing for training in Reserve Component (RC) organizations can require complex pre-execution checks. RC trainers must often conduct detailed coordination to obtain equipment, training support system products, and ammunition from distant locations. In addition, RC pre-execution checks may be required to coordinate Active Component assistance from the numbered CONUSA, training support divisions, and directed training affiliations.

b. Conduct of Training. Ideally, training is executed using the crawl-walk-run approach. This allows and promotes an objective, standards-based approach to training. Training starts at the basic level. Crawl events are relatively simple to conduct and require minimum support from the unit. After the crawl stage, training becomes incrementally more difficult, requiring more resources from the unit and home station, and increasing the level of realism. At the run stage, the level of difficulty for the training event intensifies. Run stage training requires optimum resources and ideally approaches the level of realism expected in combat. Progression from the walk to the run stage for a particular task may occur during a one-day training exercise or may require a succession of training periods over time. Achievement of the Army standard determines progression between stages.

(1) In crawl-walk-run training, the tasks and the standards remain the same; however, the conditions under which they are trained change. Commanders may change the conditions, for example, by increasing the difficulty of the conditions under which the task is being performed, increasing the tempo of the task training, increasing the number of tasks being trained, or by increasing the number of personnel involved in the training. Whichever approach is used, it is important that all leaders and Soldiers involved understand in which stage they are currently training and understand the Army standard.

(2) An AAR is immediately conducted and may result in the need for additional training. Any task that was not conducted to standard should be retrained. Retraining should be conducted at the earliest opportunity. Commanders should program time and other resources for retraining as an integral part of their training plan. Training is incomplete until the task is trained to standard. Soldiers will remember the standard enforced, not the one discussed.

c. Recovery from Training. The recovery process is an extension of training, and once completed, it signifies the end of the training event. At a minimum, recovery includes conduct of maintenance training, turn-in of training support items, and the conduct of AARs that review the overall effectiveness of the training just completed.

(1) Maintenance training is the conduct of post-operations preventive maintenance checks and services, accountability of organizational and individual equipment, and final inspections. Class IV, Class V, TADSS, and other support items are maintained, accounted for, and turned-in, and training sites and facilities are closed out.

(2) AARs conducted during recovery focus on collective, leader, and individual task performance, and on the planning, preparation, and conduct of the training just completed. Unit AARs focus on individual and collective task performance, and identify shortcomings and the training required to correct deficiencies. AARs with leaders focus on tactical judgment. These AARs contribute to leader learning and provide opportunities for leader development. AARs with trainers and evaluators provide additional opportunities for leader development.

**1-6. Training Assessment.** Assessment is the commander's responsibility. It is the commander's judgment of the organization's ability to accomplish its wartime operational mission. Assessment is a continuous process that includes evaluating individual training, conducting an organizational assessment, and preparing a training assessment. The commander uses his experience, feedback from training evaluations, and other evaluations and reports to arrive at his assessment. Assessment is both the end and the beginning of the training management process. Training assessment is more than just training evaluation, and encompasses a wide variety of inputs. Assessments include such diverse systems as training, force integration, logistics, and personnel, and provide the link between the unit's performance and the Army standard. Evaluation of training is, however, a major component of assessment. Training evaluations provide the commander with feedback on the demonstrated training proficiency of Soldiers, leaders, battle staffs, and units. Commanders cannot personally observe all training in their organization and, therefore, gather feedback from their senior staff officers and NCOs.

a. Evaluation of Training. Training evaluations are a critical component of any training assessment. Evaluation measures the demonstrated ability of Soldiers, commanders, leaders, battle staffs, and units against the Army standard. Evaluation of training is integral to standards-based training and is the cornerstone of leader training and leader development. STPs describe standards that must be met for each Soldier task.

(1) All training must be evaluated to measure performance levels against the established Army standard. The evaluation can be as fundamental as an informal, internal evaluation performed by the leader conducting the training. Evaluation is conducted specifically to enable the individual undergoing the training to know whether the training standard has been achieved. Commanders must establish a climate that encourages candid and accurate feedback for the purpose of developing leaders and trained Soldiers.

(2) Evaluation of training is not a test; it is not used to find reasons to punish leaders and Soldiers. Evaluation tells Soldiers whether or not they achieved the Army standard and, therefore, assists them in determining the overall effectiveness of their training plans. Evaluation produces disciplined Soldiers, leaders, and units. Training without evaluation is a waste of time and resources.

(3) Evaluations are used by leaders as an opportunity to coach and mentor Soldiers. A key element in developing leaders is immediate, positive feedback that coaches and leads subordinate leaders to achieve the Army standard. This is a tested and proven path to develop competent, confident adaptive leaders.

b. **Evaluators.** Commanders must plan for formal evaluation and must ensure the evaluators are trained. These evaluators must also be trained as facilitators to conduct AARs that elicit maximum participation from those being trained. External evaluators will be certified in the tasks they are evaluating and normally will not be dual-hatted as a participant in the training being executed.

c. **Role of Commanders and Leaders.** Commanders ensure that evaluations take place at each echelon in the organization. Commanders use this feedback to teach, coach, and mentor their subordinates. They ensure that every training event is evaluated as part of training execution and that every trainer conducts evaluations. Commanders use evaluations to focus command attention by requiring evaluation of specific mission essential and battle tasks. They also take advantage of evaluation information to develop appropriate lessons learned for distribution throughout their commands.

d. **After Action Review.** The AAR, whether formal or informal, provides feedback for all training. It is a structured review process that allows participating Soldiers, leaders, and units to discover for themselves what happened during the training, why it happened, and how it can be done better. The AAR is a professional discussion that requires the active participation of those being trained. FM 7-1 provides detailed instructions for conducting an AAR and detailed guidance on coaching and critiquing during training.

**1-7. Training Support.** This manual includes the following information which provides additional training support information.

a. **Glossary.** The glossary, which follows the last appendix, is a single comprehensive list of acronyms, abbreviations, definitions, and letter symbols.

b. **References.** This section contains two lists of references, required and related, which support training of all tasks in this SM. Required references are listed in the conditions statement and are required for the Soldier to do the task. Related references are materials that provide more detailed information and a more thorough explanation of task performance.

**This page intentionally left blank.**

## CHAPTER 2 Trainer's Guide

**2-1 General** The MOS Training Plan (MTP) identifies the essential components of a unit training plan for individual training. Units have different training needs and requirements based on differences in environment, location, equipment, dispersion, and similar factors. Therefore, the MTP should be used as a guide for conducting unit training and not a rigid standard. The MTP consists of two parts. Each part is designed to assist the commander in preparing a unit training plan which satisfies integration, cross training, training up, and sustainment training requirements for Soldiers in this MOS.

Part One of the MTP shows the relationship of an MOS skill level between duty position and critical tasks. These critical tasks are grouped by task commonality into subject areas.

Section I lists subject area numbers and titles used throughout the MTP. These subject areas are used to define the training requirements for each duty position within an MOS.

Section II identifies the total training requirement for each duty position within an MOS and provides a recommendation for cross training and train-up/merger training.

- Duty Position Column.** This column lists the duty positions of the MOS, by skill level, which have different training requirements.
- Subject Area Column.** This column lists, by numerical key (see Section I), the subject areas a Soldier must be proficient in to perform in that duty position.
- Cross Train Column.** This column lists the recommended duty position for which Soldiers should be cross trained.
- Train-up/Merger Column.** This column lists the corresponding duty position for the next higher skill level or MOSC the Soldier will merge into on promotion.

Part Two lists, by general subject areas, the critical tasks to be trained in an MOS and the type of training required (resident, integration, or sustainment).

- Subject Area Column.** This column lists the subject area number and title in the same order as Section I, Part One of the MTP.
- Task Number Column.** This column lists the task numbers for all tasks included in the subject area.
- Title Column.** This column lists the task title for each task in the subject area.
- Training Location Column.** This column identifies the training location where the task is first trained to Soldier training publications standards. If the task is first trained to standard in the unit, the word "Unit" will be in this column. If the task is first trained to standard in the training base, it will identify, by brevity code (ALC, SLC, etc.), the resident course where the task was taught. Figure 2-1 contains a list of training locations and their corresponding brevity codes.

<b>ASI/SD</b>	Additional Skill Identifier/Special Duty
<b>AIT</b>	Advanced Individual Training
<b>ALC</b>	Advanced Leader Course
<b>SLC</b>	Senior Leader Course
<b>Unit</b>	Training in the Unit

Figure 2-1. Training Locations

- **Sustainment Training Frequency Column.** This column indicates the recommended frequency at which the tasks should be trained to ensure Soldiers maintain task proficiency. Figure 2-2 identifies the frequency codes used in this column.

<b>BA</b>	Biannually
<b>AN</b>	Annually
<b>SA</b>	Semi-annually
<b>QT</b>	Quarterly
<b>BM</b>	Bimonthly
<b>MO</b>	Monthly
<b>BW</b>	Biweekly
<b>WK</b>	Weekly

Figure 2-2. Sustainment Training Frequency Codes

- **Sustainment Training Skill Level Column.** This column lists the skill levels of the MOS for which Soldiers must receive sustainment training to ensure they maintain proficiency to Soldier's manual standards.



2-2. Part One, Section I. Subject Area Codes.

**Skill Level 1**

- 1 Vital Signs
- 2 Medical Treatment.
- 3 Trauma Treatment.
- 4 Airway Management.
- 5 Venipuncture and IV Therapy
- 6 Primary Care
- 7 Musculoskeletal
- 8 CBRN (Chemical, Biological, Radiological, Nuclear)
- 9 Triage and Evacuation
- 10 Medication Administration
- 11 Force Health Protection

**Skill Level 2**

- 12 Medical Treatment (SL 2)
- 13 Trauma Treatment (SL 2)
- 14 Venipuncture and IV Therapy (SL2)
- 15 Primary Care (SL 2)
- 16 CBRN (Chemical, Biological, Nuclear) (SL 2)
- 17 Triage and Evacuation (SL 2)
- 18 Medication Administration (SL 2)
- 19 Force Health Protection (SL 2)

**Skill Level 3**

- 20 Medical Treatment (SL 3)
- 21 Trauma Treatment (SL 3)
- 22 Airway Management (SL 3)
- 23 Venipuncture and IV Therapy (SL 3)
- 24 Triage and Evacuation (SL 3)
- 25 Medication Administration (SL 3)

**2-3. Part One, Section II, Duty Position Training Requirements.**

<b>SKILL LEVEL</b>	<b>DUTY POSITION</b>	<b>SUBJECT AREAS</b>	<b>CROSS TRAIN</b>	<b>TRAIN-UP/MERGER</b>
SL 1	Health Care Specialist	1-11	NA	68W1 Health Care Specialist.
SL 2	Health Care Sergeant	1-12	NA	68W2 Health Care Specialist NCO
SL 3	Health Care NCO	1-13	NA	68W3 Health Care Specialist NCO

**2-4. Part Two, Critical Tasks List.****MOS TRAINING PLAN  
MOS 68W****CRITICAL TASKS**

<b>Task Number</b>	<b>Title</b>	<b>Training Location</b>	<b>Sust Tng Freq</b>	<b>Sust Tng Sl</b>
<b>Subject Area 1. Vital Signs (SL1)</b>				
081-831-0010	Measure a Patient's Respirations	AIT	SA	1
081-831-0011	Measure a Patient's Pulse	AIT	SA	1
081-831-0012	Measure a Patient's Blood Pressure	AIT	SA	1
081-831-0013	Measure a Patient's Temperature	AIT	SA	1
081-831-0164	Measure a Patients Oxygen Saturation	AIT	SA	1
<b>Subject Area 2. Medical Treatment (SL1)</b>				
081-833-0008	Initiate Treatment for a Respiratory Emergency	AIT	SA	1
081-833-0001	Initiate a Tactical Combat Casualty Care (TCCC) Card	AIT	SA	1
081-833-0116	Assist in Vaginal Delivery	AIT	SA	1
081-833-0004	Initiate Treatment for a Poisoned Casualty	AIT	A	1
081-833-0010	Change a Sterile Dressing	AIT	A	1
081-831-0033	Initiate a Field Medical Card	AIT	SA	1
081-833-0003	Initiate Treatment for Anaphylactic Shock	AIT	SA	1
081-831-0046	Administer External Chest Compressions	AIT	SA	1
081-833-0035	Initiate Treatment for High Altitude Illness	AIT	A	1
081-833-0005	Initiate Treatment for a Diabetic Emergency	AIT	SA	1
081-833-0156	Perform a Medical Patient Assessment	AIT	SA	1
081-833-0009	Initiate Treatment for a Near Drowning Casualty	AIT	A	1
081-833-0013	Initiate Treatment for an Allergic Reaction	AIT	SA	1
081-833-0014	Operate an Automated External Defibrillator	AIT	SA	1
081-831-0008	Put on Sterile Gloves	AIT	A	1
081-833-0002	Manage a Seizing Patient	AIT	SA	1
081-833-0011	Initiate Treatment for Chest Pain	AIT	SA	1
<b>Subject Area 3. Trauma Treatment (SL1)</b>				
081-833-0065	Apply a Combat Application Tourniquet (C-A-T)	AIT	Q	1
081-833-0068	Bandage an Open Wound	AIT	SA	1
081-833-0047	Initiate Treatment for Hypovolemic Shock	AIT	SA	1
081-833-0030	Initiate Treatment for an Open Chest Injury	AIT	SA	1
081-833-0044	Initiate Treatment for Chemical Burns of the Eye	AIT	A	1
081-833-0063	Initiate Treatment for a Soft Tissue Injury	AIT	A	1
081-833-0075	Perform a Needle Chest Decompression	AIT	Q	1
081-833-0078	Initiate Treatment for a Closed Chest Injury	AIT	Q	1
081-833-0061	Initiate Treatment for an Amputation	AIT	Q	1
081-833-0069	Apply an Occlusive Dressing	AIT	Q	1
081-833-0096	Perform Extrication Using a Seated Device	AIT	A	1
081-833-0181	Apply a Long Spine Board	AIT	A	1
081-833-0091	Initiate Treatment for Neck Wounds	AIT	SA	1
081-833-0124	Control Bleeding	AIT	Q	1

Task Number	Title	Training Location	Sust Tng Freq	Sust Tng Sl
081-833-0028	Initiate Treatment for an Open Abdominal Wound	AIT	SA	1
081-833-0029	Initiate Treatment for an Impaled Object	AIT	SA	1
081-833-0038	Initiate Treatment for a Head Injury	AIT	SA	1
081-833-0039	Initiate Treatment for Foreign Bodies of the Eye	AIT	A	1
081-833-0040	Initiate Treatment for Lacerations of the Eyelid	AIT	A	1
081-833-0042	Initiate Treatment for Extrusions of the Eye	AIT	A	1
081-833-0051	Initiate Treatment for Burns	AIT	SA	1
081-833-0053	Perform an EMT-B Trauma Assessment	AIT	SA	1
081-833-0066	Apply an Improvised Tourniquet	AIT	SA	1
081-833-0211	Apply a Hemostatic Dressing	AIT	Q	1
081-833-0212	Apply a Pressure Dressing to an Open Wound	AIT	Q	1
081-833-0067	Perform a Combat Casualty Assessment	AIT	Q	1
081-833-0177	Apply a Cervical Collar	AIT	A	1
081-833-0079	Initiate Treatment for Axillary Wounds	AIT	SA	1
081-833-0081	Initiate Treatment for Inguinal Wounds	AIT	SA	1
<b>Subject Area 4. Airway Management (SL1)</b>				
081-833-0098	Set Up an Oxygen Tank	AIT	SA	1
081-833-0169	Insert a Combitube®	AIT	SA	1
081-833-0142	Insert a Nasopharyngeal Airway	AIT	A	1
081-833-0170	Perform Endotracheal Suctioning	AIT	A	1
081-831-0018	Open the Airway	AIT	A	1
081-831-0019	Clear an Upper Airway Obstruction	AIT	A	1
081-831-0048	Perform Rescue Breathing	AIT	A	1
081-833-0016	Insert an Oropharyngeal Airway (J Tube)	AIT	A	1
081-833-0017	Ventilate A Patient with a Bag-Valve-Mask System	AIT	A	1
081-833-0099	Perform Oral Suctioning	AIT	A	1
081-833-0158	Administer Oxygen	AIT	A	1
081-833-0230	Insert a King LT	AIT	SA	1
081-833-3005	Perform a Surgical Cricothyroidotomy	AIT	SA	1
<b>Subject Area 5. Venipuncture and IV Therapy (SL1)</b>				
081-833-0101	Obtain a Blood Specimen	AIT	SA	1
081-833-0033	Initiate an Intravenous Infusion	AIT	SA	1
081-833-0034	Manage an Intravenous Infusion	AIT	SA	1
081-833-0185	Initiate a FAST 1	AIT	SA	1
081-835-3025	Initiate a Saline Lock	AIT	SA	1
081-833-0235	Discontinue an Intravenous Infusion	AIT	SA	1
<b>Subject Area 6. Primary Care (SL1)</b>				
081-833-0242	Provide Treatment for Sinus Infections	AIT	A	1
081-833-0254	Perform a HEENT Exam	AIT	A	1
081-833-0054	Irrigate Eyes	AIT	A	1
081-833-0240	Provide Treatment for Common Eye Infections	AIT	A	1
081-833-0243	Provide Treatment for Common Throat Infections	AIT	A	1
081-833-0245	Provide Care for Common Respiratory Disorders	AIT	A	1
081-833-0246	Provide Treatment for a Behavioral Emergency	AIT	A	1
081-833-0247	Perform a Military Acute Concussion Evaluation (MACE) Screening for Traumatic Brain Injury	AIT	A	1
081-833-0241	Provide Treatment for Common Ear Infections	AIT	A	1

Task Number	Title	Training Location	Sust Tng Freq	Sust Tng Sl
081-833-0125	Treat Skin Disorders	AIT	A	1
081-831-0007	Perform a Patient Care Handwash	AIT	SA	1
081-833-0145	Document Patient Care using Subjective, Objective, Assessment, Plan (SOAP) Note Format	AIT	SA	1
081-833-0239	Provide Treatment for Abdominal Disorders	AIT	A	1
081-833-0193	Perform Visual Acuity Testing	AIT	A	1
<b>Subject Area 7. Musculoskeletal (SL1)</b>				
081-833-0263	Apply a Rigid Splint	AIT	SA	1
081-833-0264	Apply an Elastic Bandage	AIT	SA	1
081-833-0141	Apply a Traction Splint	AIT	A	1
081-833-0269	Perform an Examination of the Shoulder	AIT	A	1
081-833-0273	Perform an Examination of the Wrist	AIT	A	1
081-833-0274	Perform an Examination of the Hip	AIT	A	1
081-833-0265	Apply a Sling and Swath	AIT	SA	1
081-833-0267	Provide Care for a Casualty with a Suspected Spinal Injury	AIT	A	1
081-833-0268	Perform an Examination of the Knee	AIT	A	1
081-833-0272	Perform an Examination of the Ankle	AIT	A	1
081-833-0266	Immobilize the Pelvis	AIT	A	1
081-833-0270	Perform an Examination of the Elbow	AIT	A	1
081-833-0271	Perform an Examination of the Back	AIT	A	1
081-833-0222	Treat Common Musculoskeletal Disorders	AIT	A	1
<b>Subject Area 8. CBRN (SL1)</b>				
081-833-0095	Decontaminate a Casualty	AIT	SA	1
081-833-0093	Set Up a Casualty Decontamination Station	AIT	SA	1
<b>Subject Area 9. Triage and Evacuation (SL1)</b>				
081-833-0283	Initiate a 9-Line Medevac Request	AIT	Q	1
081-833-0214	Load Casualties onto a UH-60 Series Helicopter	AIT	SA	1
081-833-0282	Perform Manual Evacuation	AIT	A	1
081-833-0152	Establish a Casualty Collection Point	AIT	A	1
081-833-0284	Load Casualties Onto A Mine Resistant Heavily Armored Ground Ambulance (HAGA) 6X6 RG. 33L	AIT	SA	1
081-833-0291	Unload Casualties From a Mine Resistant Heavily Armored Ground Ambulance (HAGA) 6x6 RG.33L	AIT	SA	1
081-833-0299	Prepare a SKEDCO for Hoist Operations	AIT	A	1
081-833-0294	Unload Casualties From a UH-60 Series Helicopter	AIT	SA	1
081-833-0298	Transport a Casualty Using a Litter	AIT	SA	1
081-833-0281	Triage Casualties	AIT	A	1
<b>Subject Area 10. Medication Administration (SL1)</b>				
081-833-0088	Prepare an Injection for Administration	AIT	A	1
081-833-0301	Administer an Intramuscular Injection	AIT	A	1
081-833-0303	Administer an Intradermal Injection	AIT	A	1
081-833-0304	Administer Common Medications	AIT	A	1
081-833-0302	Administer a Subcutaneous Injection	AIT	A	1
081-833-0022	Administer Inhalation Medications	AIT	A	1

Task Number	Title	Training Location	Sust Tng Freq	Sust Tng Sl
<b>Subject Area 11. Force Health Protection (SL1)</b>				
081-831-9018	Implement Suicide Prevention Measures	AIT	Q	1
081-833-0038	Initiate Treatment for a Heat Injury	AIT	SA	1
081-833-0072	Treat a Casualty for Insect Bites or Stings	AIT	SA	1
081-833-0073	Treat a Casualty for Snake Bite	AIT	A	1
081-831-0039	Treat a Casualty for a Cold Injury	AIT	SA	1
<b>Subject Area 12. Medical Treatment (SL2)</b>				
081-833-0196	Remove a Toenail	UNIT	A	2
081-833-0024	Initiate Treatment for a Paronychia	UNIT	A	2
081-833-3017	Insert a Urinary Catheter	UNIT	A	2
081-833-3022	Insert a Nasogastric Tube	UNIT	A	2
081-833-0187	Insert an Orogastric Tube	UNIT	A	2
081-833-3023	Remove a Nasogastric Tube	UNIT	A	2
081-833-0167	Place a Patient on a Cardiac Monitor	UNIT	A	2
081-833-0006	Measure a Patient's Intake and Output	UNIT	A	2
081-835-3005	Perform a Gastric Lavage	UNIT	A	2
081-833-0197	Remove a Urinary Catheter	UNIT	A	2
081-835-3007	Obtain an Electrocardiogram	UNIT	A	2
081-833-0012	Perform Wound Irrigation	UNIT	A	2
<b>Subject Area 13. Trauma Treatment (SL2)</b>				
081-833-0194	Prepare an Aid Bag	UNIT	A	2
<b>Subject Area 14. Venipuncture and IV Therapy (SL2)</b>				
081-835-3002	Administer Medications by IV Piggy Back	UNIT	A	2
081-833-0102	Operate an IV Infusion Pump	UNIT	A	2
081-833-0238	Remove a FAST 1	UNIT	SA	2
<b>Subject Area 15. Primary Care (SL2)</b>				
081-833-0244	Provide Treatment for a Subungual Hematoma	UNIT	A	2
081-833-0257	Operate a Glucometer	UNIT	A	2
081-833-0165	Perform Patient Hygiene	UNIT	A	2
081-833-0248	Obtain a Throat Culture	UNIT	A	2
081-833-0256	Test a Stool Sample	UNIT	A	2
081-833-0258	Apply Flouri-Strip to an Eye	UNIT	SA	2
081-833-0059	Irrigate an Obstructed Ear	UNIT	A	2
081-833-0255	Utilize a Urine Test Strip	UNIT	A	2
081-833-0195	Remove a Patient's Ring	UNIT	SA	2
<b>Subject Area 16. CBRN (SL2)</b>				
081-833-0276	Provide Treatment for a Blood Agent (Hydrogen Cyanide) Casualty in the Field	UNIT	SA	2
081-833-0277	Provide Treatment for a Choking Agent Casualty in the Field	UNIT	SA	2
081-833-0280	Provide Treatment for a Radiation Casualty	UNIT	SA	2
081-833-0275	Provide Treatment for a Nerve Agent Casualty in the Field	UNIT	SA	2
081-833-0278	Provide Treatment for a Blister Agent Casualty (Mustard, Lewisite, Phosgene Oxime) in the Field	UNIT	SA	2
081-833-0279	Provide Treatment for a Biological Exposed Casualty	UNIT	SA	2

Task Number	Title	Training Location	Sust Tng Freq	Sust Tng SI
<b>Subject Area 17. Triage and Evacuation (SL2)</b>				
081-833-0173	Load Casualties onto Nonstandard Vehicles, 5 Ton M-1085, M-1093, 2 1/2 Ton M-1081	UNIT	A	2
081-833-0171	Load Casualties onto Nonstandard Vehicles, 1 1/4 Ton, 4 x 4, M998	UNIT	SA	2
081-833-0287	Load Casualties Onto a CH-47 Series Helicopter	UNIT	SA	2
081-833-0226	Load Casualties onto a Stryker Armored Ambulance	UNIT	SA	2
081-833-0288	Unload Casualties From Nonstandard Vehicles, 2 1/2 Ton, 6X6 or 5 Ton, 6X6 Cargo Truck	UNIT	SA	2
081-833-0289	Unload Casualties From Nonstandard Vehicles, 5 Ton M-1085, M-1093, 2 1/2 Ton M-1081	UNIT	SA	2
081-833-0290	Unload Casualties From Nonstandard Vehicles, 1 1/4 TON, 4 x 4, M998	UNIT	SA	2
081-833-0295	Unload Casualties From a CH-47 Series Helicopter	UNIT	SA	2
081-833-0296	Unload Casualties From a Stryker Armored Ambulance	UNIT	SA	2
081-833-0172	Load Casualties onto Nonstandard Vehicles, 2 1/2 Ton, 6X6 or 5 Ton, 6X6, Cargo Truck	UNIT	SA	2
071-334-4002	Establish a Helicopter Landing Point	UNIT	A	2
<b>Subject Area 18. Medication Administration (SL2)</b>				
081-833-0020	Administer Ear Medications	UNIT	A	2
081-833-0015	Administer Eye Medications	UNIT	A	2
081-835-3020	Administer Topical Medications	UNIT	A	2
<b>Subject Area 19. Force Health Protection (SL2)</b>				
081-831-0037	Disinfect Water for Drinking	UNIT	SA	2
081-833-0076	Apply Restraining Devices to Patients	UNIT	A	2
<b>Subject Area 21. Medical Treatment (SL3)</b>				
081-833-0036	Perform a Digital Block Anesthesia	ALC	A	3
081-833-0026	Perform Suture Removal	ALC	A	3
081-833-0007	Establish a Sterile Field	ALC	A	3
081-833-0027	Perform Staple Removal	ALC	A	3
081-833-0192	Perform Abscess Incision and Drainage	ALC	SA	3
<b>Subject Area 22. Trauma Treatment (SL3)</b>				
081-833-0071	Suture a Laceration	ALC	SA	3
081-833-0087	Prepare Suture Site	ALC	SA	3
081-833-0090	Apply Local Anesthesia	ALC	SA	3
<b>Subject Area 23. Airway Management (SL3)</b>				
081-833-0168	Insert a Chest Tube	ALC	A	3
081-833-0100	Insert an Endotracheal Tube	ALC	A	3
<b>Subject Area 24. Venipuncture and IV Therapy (SL3)</b>				
081-835-3000	Administer Blood	ALC	A	3
081-835-3054	Administer Blood Products	ALC	A	3
081-833-0236	Remove an EZ Intraosseous Device	ALC	A	3
081-833-0237	Initiate an EZ Intraosseous Device	ALC	A	3

Task Number	Title	Training Location	Sust Tng Freq	Sust Tng SI
<b>Subject Area 25. Triage and Evacuation (SL3)</b>				
081-833-0227	Coordinate Casualty Treatment and Evacuation	ALC	SA	3
<b>Subject Area 26. Medication Administration (SL3)</b>				
081-833-0309	Administer Medication Through Endotracheal Tube	ALC	A	3



**CHAPTER 3****MOS/Skill Level Tasks****Skill Level 1****Subject Area 1: Vital Signs****Measure A Patient's Respirations****081-831-0010**

**Conditions:** You have a patient requiring vital signs. You will need a watch with a second hand, pen and a SF 600 (Medical Record-Chronological Record of Medical Care). You have performed a patient care hand wash. You are not in a Chemical, Biological, Radiological or Nuclear (CBRN) environment.

**Standards:** Measure the patient's respirations for 30 seconds and multiply by two.

**Performance Steps**

**CAUTION:** All body fluids should be considered potentially infectious. Always observe body substance isolation (BSI) precautions.

1. Count the number of times the chest rises (inspiration) and returns to its normal position (expiration). Each respiratory cycle (inspiration/expiration) counts as one respiration. Normal ranges for respirations for each age group are as follows:

*NOTE:* The patient should not be aware that his respirations are being counted. The conscious patient that is aware his respirations are being counted will often alter his respiratory rate by breathing slower and deeper. If a patient is speaking, this too may result in an inaccurate assessment of respirations.

- a. Adults: 12-20 breaths/min.
  - b. Children (1-10 years): 15-30 breaths/min.
  - c. Infants: (6-12 months): 25-50 breaths/min.
  - d. Infants: (0-5 months): 25-40 breaths/min.
2. Evaluate the respirations.
- a. Depth.
    - (1) Normal: deep, even movement of the chest.
    - (2) Shallow: minimal rise and fall of the chest and abdomen.
    - (3) Labored: increased effort to breathe, with possible gasping.
  - b. Quality (character).
    - (1) Normal: effortless, automatic, regular rate, even depth, noiseless, and free of discomfort.
    - (2) Dyspnea: difficult or labored breathing.
    - (3) Tachypnea: rapid respiratory rate; usually is a rate exceeding 24 breaths/min (adult).
    - (4) Noisy: snoring, rattling, wheezing (whistling), or grunting.
    - (5) Apnea: temporary absence of breathing.
3. Observe for physical characteristics of abnormal respirations.

a. Appearance: the patient may appear restless, anxious, pale, ashen, or cyanotic (blue skin color).

b. Position: the patient may alter his position by leaning forward with his hands on his legs (tripod position) or may be unable to breathe while lying down.

4. Record the rate of respirations and any observations noted (depth and quality) on the SF 600, according to local protocols and SOP.

5. Report any abnormal respirations to your supervisor immediately.

**Evaluation Preparation:**

Setup: You must count the rate with the Soldier being evaluated. If you are using a simulated patient, you may evaluate step 2 by having the patient purposely exhibit abnormal breathing characteristics. A tolerance of  $\pm 2$  counts will be allowed during the evaluation.

Brief Soldier: Tell the Soldier to count and record a patient's respirations.

<b>Performance Measures</b>	GO	NO GO
1 Counted the number of respirations for 30 seconds and multiplied by two.	_____	_____
2 Evaluated the respirations.	_____	_____
3 Observed for physical characteristics of abnormal respirations.	_____	_____
4 Recorded the number of respirations on SF 600.	_____	_____
5 Reported any abnormal respirations to the supervisor immediately.	_____	_____

**Evaluation Guidance:** Score each Soldier according to the performance measures. Unless otherwise stated in the task summary, the Soldier must pass all performance measures to be scored GO. If the Soldier fails any steps, show the Soldier what was done wrong and how to do the task correctly.

**References**

**Required**  
SF 600

**Related**  
None

## Measure a Patient's Pulse

081-831-0011

**CAUTION:** All body fluids should be considered potentially infectious. Always observe body substance isolation (BSI) precautions.

**Conditions:** You have a patient requiring vital signs. You will need a watch with a second hand, a pen and a SF 600 (Medical Record-Chronological Record of Medical Care). You have performed a patient care hand wash. You are not in a CBRN environment.

**Standards:** Count a patient's pulse for a minimum of 30 seconds, a full minute if irregularities were detected. Identify any demonstrated abnormalities in the pulse rate, rhythm, and strength.

### Performance Steps

1. Position the patient so the pulse site is accessible.
2. Palpate (feel) the pulse site.
  - a. Place the tips of your index and middle fingers on the pulse site. Do not use your thumb to palpate a pulse as your thumb has its own pulse.
  - b. Apply moderate pressure with your fingers to palpate the pulse.

*NOTE:* In responsive patients, older than 1 year, you should palpate the radial pulse at the wrist. In unresponsive patients, older than 1 year, you should palpate the carotid pulse at the neck. In patients less than 1 year of age, palpate the brachial pulse.

3. Count the number of pulses felt in a 30 second period and multiply by two. A pulse that is weak, difficult to palpate, or irregular should be palpated and counted for a full minute.
  - a. The normal pulse rates (at rest) are as follows:
    - (1) Adults: 60-100 beats/min.
    - (2) Children (1-6 years): 70-120 beats/min.
    - (3) Infants: (6-12 months): 80-140 beats/min.
    - (4) Infants: (0-5 months): 90-140 beats/min.
  - b. Pulse rates in an adult patient that exceed 100 beats/min are described as tachycardia.
  - c. Pulse rates less than 60 beats/min are described as bradycardia.

*NOTE:* Pulse rates can vary from patient to patient. In well-conditioned athletes or patients taking certain heart medications, the pulse rate may be considerably lower. In these adult patients, bradycardia may be considered normal.

4. Evaluate the pulse rhythm (regularity).
  - a. Regular rhythm.
    - (1) Usually easy to find.
    - (2) Has a regular rate and rhythm.
    - (3) Varies with the individual.
  - b. Irregular rhythm (any change from a regular beating pattern).

**NOTE:** If the pulse is irregular or intermittent, you should palpate a second pulse at the carotid or femoral site. All patients presenting with an irregular pulse rhythm should be referred to a medical officer.

5. Evaluate the pulse strength.
  - a. Strong (full) pulse.
    - (1) Usually easy to find.
    - (2) Beats evenly and forcefully.
  - b. Bounding (stronger than normal) pulse.
    - (1) Easy to find.
    - (2) Exceptionally strong heartbeats that make the arteries difficult to compress.
  - c. Weak (thready) pulse.
    - (1) Usually difficult to find.
    - (2) Weak and thin.
6. Record the rate, rhythm, strength, and any significant deviations from normal on the SF 600, according to local protocols and SOP.
7. Report any significant pulse abnormalities to your supervisor immediately.

**Evaluation Preparation:**

Setup: You must count the pulse rate with the Soldier being evaluated by palpating a corresponding site. Specify which site the Soldier is to palpate. A tolerance of  $\pm 2$  beats/min will be allowed during the evaluation.

Brief Soldier: Tell the Soldier to count and record the patient's pulse.

<b>Performance Measures</b>	GO	NO GO
1 Positioned the patient so the pulse site was accessible.	_____	_____
2 Palpated the pulse site.	_____	_____
3 Counted and evaluated the pulse rate.	_____	_____
4 Evaluated the pulse rhythm.	_____	_____
5 Evaluated the pulse strength.	_____	_____
6 Recorded the rate, rhythm, strength, and any significant deviations from normal on the SF 600.	_____	_____
7 Reported any significant pulse abnormalities to the supervisor immediately.	_____	_____

**Evaluation Guidance:** Score each Soldier according to the performance measures. Unless otherwise stated in the task summary, the Soldier must pass all performance measures to be scored GO. If the Soldier fails any steps, show what was done wrong and how to do it correctly.

**References**

**Required**  
SF 600

**Related**  
None

## Measure a Patient's Blood Pressure

081-831-0012

**CAUTION:** All body fluids should be considered potentially infectious. Always observe body substance isolation (BSI) precautions.

**Conditions:** You have a patient requiring vital signs. You will need a sphygmomanometer, stethoscope, pen and SF 600 (Medical Record-Chronological Record of Medical Care). You have performed a patient care hand wash. You are not in a CBRN environment.

**Standards:** Measure a patient's blood pressure.

### Performance Steps

1. Explain the procedure to the patient, if necessary.
  - a. The length of time the procedure will take.
  - b. The site to be used.
  - c. The physical sensations the patient will feel.
2. Select the proper size of sphygmomanometer cuff.

*NOTE:* The cuff width should wrap around the arm 1-1.5 times and take up two-thirds of the upper arm length, if using the brachial artery, and two-thirds of the upper leg length if using the popliteal artery.

*NOTE:* A cuff that is too small may result in falsely high readings; a cuff that is too large may result in falsely low readings.

3. Check the equipment.
  - a. Ensure the cuff is completely deflated and fully retighten the one-way valve thumbscrew.
  - b. Ensure the sphygmomanometer pressure gauge is reading zero.

*NOTE:* The following procedures describe the procedure for obtaining a blood pressure reading using the upper arm (brachial artery).

4. Position the patient and cuff.
  - a. Place the patient in a relaxed and comfortable sitting, standing, or lying position.

*NOTE:* Measuring the blood pressure of a standing patient will result in a slightly higher reading.

b. With the patient's arm extended, at approximately heart level and with the palm up, place the cuff over the brachial artery. Ensure the lower edge of the cuff is 1-2 inches above the elbow and the bladder portion is over the artery.

- c. Wrap the cuff just tightly enough to prevent slippage.
  - d. Support the arm so it is in a relaxed state.
5. Palpate the brachial artery to determine where to place the stethoscope.

6. Place the diaphragm of the stethoscope over the pulse site and hold it firmly pressed against the artery with the fingers of your nondominant hand.

**CAUTION:** The cuff should not remain inflated for more than 2 minutes.

7. With the valve closed tightly, inflate the cuff using the ball-pump until the cuff reads at least 160 mm Hg (millimeters of mercury) or until you no longer hear the pulse sounds. Continue pumping to increase the cuff's pressure by an additional 30 mm Hg.

8. Determine the blood pressure reading.

a. If a stethoscope is used, complete the following steps:

(1) Rotate the thumbscrew in a counter clockwise motion, allowing the cuff to deflate slowly at about 3 mm Hg per second.

(2) Watch the gauge and listen carefully. Note the patient's systolic blood pressure as the first distinct "taps" or "thumps" of the pulse waves that can be heard clearly.

(3) Continue to watch the gauge and note the reading where the sound changes again or becomes muffled or disappears. This will be the diastolic blood pressure.

(4) As soon as the pulse sounds cease, open the valve by rotating the thumbscrew and release the remaining air rapidly.

b. If a stethoscope is not used, complete the following steps:

*NOTE:* If in a very noisy environment where hearing the pulse waves is difficult or impossible, the palpation method may be used.

(1) With your nondominant hand, palpate the radial pulse (at the wrist) on the same arm as the cuff.

(2) While palpating the radial pulse, rapidly inflate the cuff until you can no longer feel the pulse under your fingertips, and then inflate an additional 30 mm Hg above where you last felt the radial pulse.

(3) Rotate the thumbscrew in a counter clockwise motion, allowing the cuff to deflate slowly at about 3 mm Hg per second.

(4) Watch the gauge, when you again feel the radial pulse return, note the reading on the gauge (systolic blood pressure).

*NOTE:* The diastolic pressure cannot be determined using this method. If the procedure must be repeated, wait at least 1 minute before repeating the procedure.

(5) As soon as you note the systolic reading, open the valve by rotating the thumbscrew and release the remaining air rapidly.

9. Record the blood pressure on the appropriate medical forms.

a. Record the systolic reading over the diastolic reading, for example 120/80.

b. If obtaining the blood pressure without a stethoscope (by palpation), record the systolic reading alone alongside the letter "P", for example 120/P.

c. Record all readings in even numbers.

*NOTE:* Record the blood pressure readings with the time it was taken on the SF 600.

10. Evaluate the blood pressure readings by noting the normal ranges for the blood pressure.

a. Adults: 90-140 mm Hg (systolic); 60-90 mm Hg (diastolic).

b. Children: (1-10 years): 80-110 mm Hg (systolic).

c. Infants: (0-12 months): 70 mm Hg (systolic).

*NOTE:* Blood pressure readings vary with age and gender. A patient has hypotension when the blood pressure is lower than the normal range; the patient has hypertension when the blood pressure is higher than the normal range.

11. Report any abnormal blood pressure findings to the supervisor immediately.

**Evaluation Preparation:**

Setup: A double stethoscope should be used if available. A tolerance of  $\pm 4$  mm Hg will be allowed. If other methods are used, such as independent measurements on different sites or at different times, the evaluator must apply discretion in applying the  $\pm 4$  mm Hg standard. You will allow the Soldier to retake the blood pressure at least once if the Soldier feels that it is necessary to obtain an accurate reading. You will use discretion in allowing additional repetitions based upon the difficulty of obtaining a reading on the patient during the evaluation.

Brief Soldier: Tell the Soldier to take a patient's blood pressure. Tell the Soldier that the blood pressure may be retaken, if necessary, to obtain an accurate reading.

<b>Performance Measures</b>	GO	NO GO
1 Explained the procedure to the patient, if necessary.	_____	_____
2 Selected the proper size of sphygmomanometer cuff.	_____	_____
3 Checked the equipment.	_____	_____
4 Positioned the patient and cuff.	_____	_____
5 Palpated brachial artery.	_____	_____
6 Positioned the stethoscope, if used.	_____	_____
7 Inflated the cuff until the gauge read at least 160 mm Hg or until pulse sounds could no longer be heard.	_____	_____
8 Determined the blood pressure.	_____	_____
9 Recorded the blood pressure on the SF 600.	_____	_____
10 Evaluated the blood pressure.	_____	_____
11 Reported any abnormal readings to the supervisor immediately.	_____	_____

**Evaluation Guidance:** Score each Soldier according to the performance measures. Unless otherwise stated in the task summary, the Soldier must pass all performance measures to be scored GO. If the Soldier fails any steps, show what was done wrong and how to do it correctly.

**References**

**Required**  
SF 600

**Related**  
None

## Measure a Patient's Temperature

081-831-0013

**CAUTION:** All body fluids should be considered potentially infectious so always observe body substance isolation (BSI) precautions by wearing gloves and eye protection as a minimal standard of protection.

**Conditions:** You have a patient requiring vital signs. You will need a watch, electronic thermometer, alcohol pads, cover probes, water soluble lubricant, pen and SF 600 (Medical Record-Chronological Record of Medical Care). You have performed a patient care hand wash. You are not in a CBRN environment.

**Standards:** Measure the patient's temperature to the nearest 0.2° F.

### Performance Steps

1. Determine which site to use.

**CAUTIONS:** Do not take an oral temperature when the patient-- 1. Has had recent facial or oral surgery. 2. Is unable to follow directions (confused, disturbed, or heavily sedated). 3. Is being administered oxygen by mouth or nose. 4. Is likely to bite down on the thermometer. 5. Has smoked, chewed gum or has eaten or drank anything hot or cold within the last 15 to 30 minutes.

a. Take an oral temperature if the patient is a conscious adult or child who can follow directions and can breathe normally through their nose.

**CAUTION:** Do not attempt to take a tympanic temperature if the patient has had recent facial or ear surgery or has cerumen (ear wax) impaction.

b. The tympanic method may be used with conscious or unconscious patients and is the preferred method if the patient has recently had anything to eat or drink.

**CAUTION:** Do not attempt to take a rectal temperature if the patient has had recent rectal surgery, unless directed to by a medical officer. Do not attempt to take a rectal temperature on an infant unless directed by a medical officer.

c. Obtain the patient's temperature by the rectal method if the oral or tympanic methods are ruled out by the patient's condition.

d. Obtain the patient's temperature by the axillary (least preferred) method if the patient's condition rules out using the other methods.

2. Select the appropriate thermometer.

a. Tympanic thermometer.

b. Oral thermometer: has a blue tip and may be labeled "Oral."

c. Rectal thermometer: has a red tip and may be labeled "Rectal."

d. Axillary temperatures may be obtained using an oral thermometer.

3. Explain the procedure and position the patient appropriately.

a. Tympanic method. Position the patient with their head turned to make the ear canal easily accessible.

b. Oral method. Position the patient seated or lying down.

c. Rectal method. Position the patient lying on either side with the top knee flexed.



d. Axillary method. Position the patient either seated or lying face up with the armpit exposed.

4. Measure the temperature.

a. Place the thermometer at the proper site.

(1) Oral method. Ensure cover probe is firmly attached to the appropriate probe attachment. Digital disinfect the thermometer with an alcohol pad. Insert it into the disposable sheath opening; then twist to tear the seal at the dotted line. Pull it apart. Place the thermometer underneath the patient's tongue. Instruct the patient to close their lips around the instrument firmly but not to bite down.

**CAUTION:** The rectal thermometer with the cover probe attached must be lubricated with a water soluble lubricant prior to insertion. Once inserted, do not let go of the thermometer.

(2) Rectal method. Ensure cover probe is firmly attached to the appropriate probe. In an adult, insert the thermometer 1 to 2 inches into their rectum. Lift the patient's upper buttock and ask the patient to take a slow deep breath. This helps relax the anal sphincter to ease insertion of the thermometer.

(3) Tympanic method. Pull the ear pinna upward and rearward; insert the thermometer speculum into the ear canal snugly to create a seal, pointing toward the nose.

(4) Axillary method. Pat the armpit dry and place the tip end of an oral thermometer with cover probe firmly attached, in the center of the armpit with the probe attachment tip protruding to the front of the patient's body. Place the patient's arm across his chest.

b. Leave the thermometer in place for the required time.

(1) Oral method: must remain in place for at least 3 minutes.

*NOTE:* If using a digital oral thermometer, leave in place until testing is complete. The digital unit will normally have an audible tone.

(2) Rectal method: must be held in place for at least 2 minutes.

(3) Tympanic method: must remain in place until an audible signal occurs and the patient's temperature appears on the digital display.

(4) Axillary method: must remain in place for at least 10 minutes.

5. Remove the thermometer and eject the cover probe, or discharge the protective plastic sheath as appropriate.

6. Read the temperature scale or digital display.

7. Evaluate the temperature reading. The normal temperature ranges are as follows:

a. Oral method: 97.0° to 99.0° F.

b. Rectal method: 98.0° to 100.0° F.

c. Tympanic method: 97.0° to 99.0° F.

d. Axillary method: 96.0° to 98.0° F.

8. Place the thermometer back on the charger or turn off as appropriate.

9. Record the patient's temperature to the nearest 0.2° F on the appropriate medical forms. Record a rectal temperature with an "R" on the patient's record; with an axillary reading, use an "A" on the patient's record.

10. Report any significant temperature abnormalities to the supervisor immediately.

**Evaluation Preparation:**

Setup: To test step 1 for evaluation purposes, create a scenario in which the patient's condition will dictate which site the Soldier must choose. A tolerance of  $\pm 0.2^\circ$  F will be allowed during the evaluation.

Brief Soldier: Tell the Soldier to measure, evaluate, and record a patient's temperature.

<b>Performance Measures</b>	GO	NO GO
1 Determined an appropriate site to use.	_____	_____
2 Selected the appropriate thermometer.	_____	_____
3 Explained the procedure and positioned the patient.	_____	_____
4 Inserted the thermometer properly and left in place for the appropriate time.	_____	_____
5 Removed the thermometer and ejected cover probe or discharged the plastic sheath appropriately.	_____	_____
6 Read the temperature from the digital display.	_____	_____
7 Evaluated the temperature.	_____	_____
8 Placed the thermometer back on the charger or turned off as appropriate.	_____	_____
9 Recorded the temperature to the nearest $0.2^\circ$ F correctly on the SF 600.	_____	_____
10 Reported any significant temperature abnormalities to the supervisor immediately.	_____	_____

**Evaluation Guidance:** Score each Soldier according to the performance measures. Unless otherwise stated in the task summary, the Soldier must pass all performance measures to be scored GO. If the Soldier fails any step, show what was done wrong and how to do it correctly.

**References**

**Required**  
SF 600

**Related**  
None

## Measure a Patients Oxygen Saturation

**081-831-0164**

**Condition:** You need to measure a patient's pulse oxygen saturation. You will need a pulse oximetry device, sensing probe, alcohol swabs, pen and SF 600 (Medical Record-Chronological Record of Medical Care). You have performed a patient care hand wash. You are not in a CBRN environment.

**Standards:** Measure a patient's pulse oxygen saturation.

### Performance Steps

**CAUTION:** All body fluids should be considered potentially infectious. Always observe body substance isolation (BSI) precautions by wearing gloves and eye protection as a minimal standard of protection.

1. Select the appropriate sensing probe location for the patient.
  - a. For adults, sensing probes can be placed on the index, middle, or ring finger.
  - b. Sensing probes can also be placed on the toe unless the patient has decreased circulation to the lower extremities.
  - c. Earlobe clips and neonate sensing probes for the foot are available for infants and newborns.
2. Wipe the selected site with alcohol to ensure it is clean and dry.
3. Apply the sensor so that the emitting light is directly opposite to the detector.
4. Attach the sensor cable to the machine and turn the power on.
5. Notify the medical officer if the digital readout is below the prescribed parameters.

**NOTE :** Normal pulse oximetry values will be greater than 95% in room air, with the majority being between 98% and 100%. Factors that may provide falsely high readings include carbon monoxide poisoning, hypovolemia, and certain types of toxins.

6. Document the oximeter reading, the location of the device, the time taken, and the amount of oxygen being delivered (if applicable) on the SF 600.
7. Take appropriate measures for continuous monitoring, if applicable.

- a. Ensure the alarms are on before leaving the patient.

**NOTE:** Monitors come with preset limits. These limits can be changed per medical officer's order.

**CAUTION:** The pulse oximeter is just a tool; do not rely on it solely for indications of the patient's condition. Treat the patient, not the machine.

- b. Move sensing probe locations every 2 hours; move adhesive sensors every 4 hours.

**Evaluation Preparation:** Score each Soldier according to the performance measures in the evaluation guide. Unless otherwise stated in the task summary, the Soldier must pass all performance measures to be scored GO. If the Soldier fails any step, show what was done wrong and how to do it correctly.

**Setup:** Have all materials present for the evaluation. Have another Soldier act as the patient. Tell the patient not to assist the Soldier in any way.

**Brief the Soldier:** Tell the Soldier to measure the patient's pulse oxygen saturation.

<b>Performance Measures</b>	GO	NO GO
1 Selected the appropriate location to attach the sensing probe.	_____	_____
2 Wiped the selected site and ensured it was clean and dried.	_____	_____
3 Applied the sensing probe.	_____	_____
4 Attached the sensing probe cable to the monitor and turned the power on.	_____	_____
5 Notified the medical officer of abnormal readings.	_____	_____
6 Documented the oximeter reading, the location of the device, the time taken, and the amount of oxygen being delivered (if applicable) on the SF 600.	_____	_____
7 Took appropriate measures for continuous monitoring, if applicable.	_____	_____

**Evaluation Guidance:** Score each Soldier according to the performance measures in the evaluation guide. Unless otherwise stated in the task summary, the Soldier must pass all performance measures to be scored a GO. If the Soldier fails any step, show what was done wrong and how to do it correctly.

**References**

**Required**  
SF 600

**Related**  
None

**Subject Area 2: Medical Treatment**  
**Initiate Treatment for a Respiratory Emergency**  
**081-833-0008**

**Conditions:** You have a conscious patient with a respiratory emergency. You will need a stethoscope, pulse oximeter, oxygen tank, nasal cannula, oxygen mask and tubing, hand held metered dose inhaler (MDI) with spacer and the patient's medical records or a DD Form 1380 US Field Medical Card (FMC). You are not in a CBRN environment.

**Standards:** Correctly identify and initiate treatment for the respiratory emergency without causing further harm to the patient.

**Performance Steps**

1. Examine the patient.

**CAUTION:** A patient experiencing respiratory distress can rapidly progress to full arrest. Always be prepared to utilize advanced airway procedures.

- a. Assess the airway and open it, if necessary. (See task 081-831-0018.)
  - (1) Ask the patient a question requiring more than a yes or no answer.
  - (2) Note whether or not the patient can speak in full sentences.
  - (3) Look for the presence of drooling that may indicate a partial or complete airway obstruction.
- b. Assist with artificial ventilations if respiratory effort and rate are inadequate.
  - (1) Look for the rise and fall of the chest during inspiration and expiration.
  - (2) Listen for the presence of noisy respirations (e.g., stridor, wheezing).
- c. Apply supplemental oxygen by mask or nasal cannula.

**NOTE:** Any patient complaining of difficulty breathing should receive supplemental oxygen.

- d. Place the patient in the position of comfort.

**NOTE:** Most patients experiencing difficulty breathing prefer to remain in a seated position.

- e. Obtain a complete set of vital signs to include pulse oximetry, if available.
2. Perform a focused physical examination.
    - a. Listen to the anterior and posterior lung fields with the stethoscope.
    - b. Look at the chest and abdomen and note the presence of any retractions.
    - c. Check the skin for the presence of cyanosis.
    - d. Check the lower extremities for the presence of edema.
  3. Obtain a focused history.
    - a. Ask the patient if there is an existing condition such as asthma.
    - b. Ask the patient if he is taking any medications.
    - c. Question the patient about allergies to medications.
    - d. Ask the patient if difficulty breathing was of sudden or gradual onset.
  4. Assist the patient in using a metered dose inhaler.

**NOTE:** This step may only be performed if the patient has an inhaler prescribed to him.

- a. Perform the five rights of medication usage.
- b. Have the patient exhale deeply.
- c. Have the patient place his lips around the opening and press the inhaler to activate the spray as he inhales deeply.
- d. Instruct the patient to hold his breath as long as possible before exhaling.
- e. Repeat steps 4b through 4d.
5. Document the procedure on FMC.
6. Transport the patient.

**Evaluation Preparation:**

Setup: For training and evaluation, use another Soldier to be the simulated patient.

Brief Soldier: Tell the Soldier the simulated patient has a respiratory emergency and they will need to initiate treatment.

<b>Performance Measures</b>	GO	NO GO
1 Examined the patient.	_____	_____
2 Performed a focused physical examination.	_____	_____
3 Obtained a focused history.	_____	_____
4 Assisted the patient in using a metered dose inhaler.	_____	_____
5 Documented the procedure on FMC.	_____	_____
6 Transported the patient.	_____	_____

**Evaluation Guidance:** Score each Soldier according to the performance measures in the evaluation guide. Unless otherwise stated in the task summary, the Soldier must pass all performance measures to be scored a GO. If the Soldier fails any step, show what was done wrong and how to do it correctly.

**References**

**Required**  
DD Form 1380

**Related**  
None

## Initiate a Tactical Combat Casualty Care (TCCC) Card

**081-833-0001**

**CAUTION:** All body fluids should be considered potentially infectious. Always observe body substance isolation (BSI) precautions by wearing gloves and eye protection as a minimal standard of protection.

**Conditions:** You have treated a casualty for injury or illness and must record the treatment given. You will need DA Form 7656, Tactical Combat Casualty Care (TCCC) Card, and a pen or pencil. You are not in a CBRN environment.

**Standards:** Complete the Tactical Combat Casualty Care Card.

### Performance Steps

1. Remove the Tactical Combat Casualty Card from the casualty's improved first aid kit (IFAK).

2. Complete all entries as fully as possible.

*NOTE:* As the TCCC Card is the first, and sometimes only, record of treatment of combat casualties, accuracy and thoroughness of information provided is of the utmost importance.

a. Front of Card.

(1) Name/Unit-Write the Soldier's name and unit.

(2) DTG (date, time, group) - Add date and time and group. For example, 2 PM on 15 Aug 2010 would be: "151400AAUG2010".

(3) Allergies-Write the Soldier's known medication allergies; if no allergies, record NKDA (no known drug allergies).

(4) Friendly, unknown, NBC- Circle which exposure resulted in this injury (friendly; exposure unknown; or NBC (nuclear, biological, chemical).

(5) TQ (tourniquet) time-If a tourniquet is applied, circle TQ and write the time of the tourniquet application.

(6) Body picture-Mark an "X" at the site of the injury (ies) on the body picture. For burn injuries, circle the burn percentage(s) on the figure.

(7) GSW, BLAST, MVA Other \_\_\_\_\_ - Circle the cause of injury (gunshot wound, blast, motor vehicle accident, other, specify).

(8) Time, AVPU, Pulse, Resp, BP-record the level of consciousness AVPU (alert, verbal stimulus, painful stimulus, unresponsive) and vital signs (pulse, respiration, blood pressure) with time.

b. Back of Card.

(1) A-Circle airway interventions (intact, Adjunct, Cric (cricothyrotomy) Intubated).

(2) B-Circle breathing interventions (Chest seal, NeedleD (needle decompression, Chest Tube).

(3) C-Circle bleeding control measures addressing Circulation. Don't forget tourniquet time on front of card (TQ (tourniquet), Hemostatic, Packed, PressureDrsng (pressure dressing).

(4) Fluids-Circle route of fluid (IV (intravenous) or IO (intraosseous)), type (NS (normal saline solution)), LR (lactated ringer's solution), Hextend® and amount given. Specify other fluids.

(5) Drugs-Record the type, dose, route of any drugs given (pain medications, ABX (antibiotics), or other).

(6) Other-use the other section to record any other pertinent notes and to explain any action that needs clarification.

(7) Name-The first responder will sign the card.

*NOTE:* When more space is needed for documentation, attach another DA Form 7656 to the original by safety pin or other means. The second form will be labeled DA Form 7656 #2 and will show the Soldier's name and unit.

3. Attach the completed TCCC Card to the casualty's belt loop or insert into the left upper arm pocket/left lower leg pants pocket, once completed. If attached, keep the TCCC Card in plain view.

*NOTE:* Do not attach the TCCC Card to the casualty's body armor as this equipment may will be separated from the casualty once they arrive at the medical treatment facility (MTF).

**Evaluation Preparation:**

Setup: For training and evaluation construct a combat casualty scenario. Have another Soldier act as a casualty and have him respond to the Soldier's questions with personal data according to the scenario provided. Ensure the Soldier acting as the casualty has read the scenario thoroughly.

Brief Soldier: Tell the Soldier to complete the TCCC Card by asking appropriate questions of the casualty. Tell the casualty to respond to the Soldier's questions with necessary information according to the scenario provided. After the card is filled out, ask the Soldier what must be done with the TCCC Card.

<b>Performance Measures</b>	GO	NO GO
1 Removed the TCCC Card from the casualty's IFAK.	_____	_____
2 Completed all entries.	_____	_____
3 Attached the TCCC Card to the casualty or inserted it into the left upper arm pocket or left lower leg pocket.	_____	_____

**Evaluation Guidance:** Score each Soldier according to the performance measures. Unless otherwise stated in the task summary, the Soldier must pass all performance measures to be scored GO. If the Soldier fails any steps, show what was done wrong and how to do it correctly.

**References**

**Required**  
DA Form 7656

**Related**  
None



## **Assist in Vaginal Delivery**

**081-833-0116**

**Conditions:** You encounter a woman who is in labor and must assist in her delivery. You will need a sterile obstetric kit (if kit is not available, you will need clean sheets and towels, heavy flat twine or new shoelaces, plastic bag, scissors, sterile pad, warm blanket, and clean, unused examination gloves). You are not in a CBRN environment.

**Standards:** Assist with vaginal delivery without causing further injury to the patient.

### **Performance Steps**

1. Assist with the first stage of labor.

*NOTE:* 1. Scene size-up, initial assessment, focused history, examination, detailed physical examination, ongoing assessment, and evacuate assessment steps must be taken to ensure that injury(ies) or illness is/are not over looked resulting in further injury to the patient. 2. Evacuate an expecting mother unless delivery is expected within a few minutes.

- a. Interview the pregnant woman. Request health history.

(1) Present pregnancy history. Is this your first pregnancy? Have there been complications during your pregnancy?

(2) Medical history. Is there a history of diabetes, hypertension, or chronic diseases?

(3) Obstetric history. How many times have you been pregnant?

- b. Assess general appearance and behavior.

c. Check vital signs between contractions. If hypotension occurs, place the patient on her left side, administer oxygen (if available), and notify the health care provider immediately.

- d. Assess the labor pattern status.

(1) Contractions-initial onset, frequency, and duration.

(2) Discomfort or pain.

e. Assess amniotic membranes status. Inquire if the patient has experienced constant leakage or rupture of vaginal fluid.

2. Assist with the second stage of labor.

- a. Assist with delivery of the infant as directed by health care provider.

*NOTE:* If the medic is in an isolated environment and is unable to evacuate the patient, the medic will deliver the infant.

b. Determine if the umbilical cord is around the infant's neck as the infant is being born. Place two fingers under the cord at the back of the baby's neck. Bring the cord forward, over the baby's upper shoulder and head. If you cannot loosen or slip the cord over the baby's head, clamp the cord in two places and, with extreme care, cut the cord between the two clamps and unwrap the ends of the cord from around the baby's neck and proceed with the delivery.

- c. Support the head after the infant's head is born.

d. Suction the mouth two or three times and the nostrils. Avoid contact with the back of the mouth.

- e. Support the infant with both hands as the torso and full body are born.

f. Wipe blood and mucus from the mouth and nose with sterile gauze. Suction the mouth and nose again.

g. Clamp, tie, and cut the umbilical cord (between the clamps) as pulsations cease approximately four finger widths from the infant.

h. Wrap the infant in a warm blanket and place on its side, head slightly lower than the trunk.

3. Assist with the third stage of labor.

a. Observe for delivery of the placenta while preparing the mother and infant for evacuation.

b. Place a sterile pad over the vaginal opening and lower the patient's legs.

c. Record the time of delivery and evacuate the mother, infant, and placenta to the hospital.

4. Provide initial care for the newborn.

a. Position, dry, wipe, and wrap the newborn in a blanket and cover the head.

b. Perform appearance, pulse, grimace, activity, and respirations (APGAR) testing at 1 and 5 minutes after birth.

(1) Appearance (color)-no central (trunk) cyanosis.

(2) Pulse-greater than 100/min.

(3) Grimace-vigorous and crying.

(4) Activity-good motion in extremities.

(5) Respirations, breathing effort-normal, crying.

**Evaluation Preparation:**

Setup: For training and evaluation, use a birthing simulation device.

Brief Soldier: Tell the Soldier the simulated patient requires assistance with her imminent delivery.

**Performance Measures**

	GO	NO GO
1 Assisted with the first stage of labor.	_____	_____
2 Assisted with the second stage of labor.	_____	_____
3 Assisted with the third stage of labor.	_____	_____
4 Provided initial care for the newborn.	_____	_____

**Evaluation Guidance:** Score each Soldier according to the performance measures. Unless otherwise stated in the task summary, the Soldier must pass all performance measures to be scored GO. If the Soldier fails any steps, show what was done wrong and how to do it correctly.

**References**

**Required**  
None

**Related**  
None

## Initiate Treatment for a Poisoned Casualty

081-833-0004

**Conditions:** You have a patient that has been poisoned and all other more serious injuries have been assessed and treated. You have taken body substance isolation (BSI) precautions and have performed an initial assessment. You will need activated charcoal, airway adjuncts, oxygen, water source, suction equipment and a DD Form 1380 US Field Medical Card (FMC), or patient's medical record,. You are not in a CBRN environment.

**Standards:** Initiate treatment for a poisoned casualty without causing further injury.

### Performance Steps

**CAUTION:** If determination cannot be made to the type of poisoning, the casualty should be treated by the symptoms presented.

1. Determine the type of poisoning.
  - a. Ingested poisons.
    - (1) Altered mental status.
    - (2) Nausea/vomiting.
    - (3) Abdominal pain.
    - (4) Diarrhea.
    - (5) Chemical burns around the mouth.
    - (6) Unusual breath odors.
  - b. Inhaled poisons.
    - (1) Carbon monoxide.
      - (a) Headache.
      - (b) Dizziness.
      - (c) Dyspnea.
      - (d) Nausea/vomiting.
      - (e) Cyanosis.
      - (f) Coughing.
    - (2) Smoke Inhalation.
      - (a) Dyspnea.
      - (b) Coughing.
      - (c) Breath that has a smoky smell or the odor of chemicals involved at the scene.
      - (d) Black residue in any sputum coughed up by the casualty.
      - (e) Nose-hairs singed from super-heated air.
  - c. Injected poisons.
    - (1) Sympathomimetics (Uppers- example: cocaine).
      - (a) Excitement.

- (b) Tachycardia.
- (c) Tachypnea.
- (d) Dilated pupils.
- (e) Sweating.
- (2) Sedative-Hypnotics (downers-example; Valium®, Xanax®).
  - (a) Sluggish.
  - (b) Sleepy typical coordination of body and speech.
  - (c) Pulse and breathing rates are low, often to the point of a true emergency.
- (3) Hallucinogens.
  - (a) Tachycardia.
  - (b) Dilated pupils.
  - (c) Flushed face.
  - (d) Often sees or hears things, has very little concept of time.
- (4) Narcotics.
  - (a) Reduced rate of breathing.
  - (b) Dyspnea.
  - (c) Low skin temperature.
  - (d) Muscles relaxed.
  - (e) Pinpoint pupils.
  - (f) Very sleepy.
- d. Absorbed poisons.
  - (1) Liquid or powder on the casualty's skin.
  - (2) Burns.
  - (3) Itching.
  - (4) Irritation.
  - (5) Redness.

2. Initiate treatment for the poisoned casualty.

a. Ingested poisons.

- (1) Maintain the airway.
- (2) Gather all information about the type of ingested poisoning.

**CAUTION:** Activated charcoal is contraindicated for casualties that have an altered mental status, that you suspect have swallowed acids or alkalis, or that are unable to swallow.

- (3) Administer activated charcoal.

**NOTE:** Be prepared to provide oral suctioning if the casualty starts to vomit. All vomitus must be saved.

- (a) Adults and children: 1 gram of activated charcoal/kg of body weight.
- (b) Usual adult dose: 25-50 grams.
- (c) Usual pediatric dose-(1-10 years): 12.5-25 grams.
- (4) Give supplemental oxygen.
- (5) Record the name, dose, and time of administration of medication.
- (6) Transport to the nearest medical treatment facility.
- b. Inhaled poisons.
  - (1) Remove the casualty from the unsafe environment.
    - (a) Maintain the airway.
    - (b) Administer high concentrations of oxygen.

*NOTE:* This is the most important treatment for inhalation poisoning.

- (2) Transport to the nearest medical treatment facility.
- (3) Document interventions.
- c. Absorbed poisons.
  - (1) Remove the casualty from the source.
  - (2) Remove contaminated clothing.
  - (3) Brush off any powders from the casualty's skin.
  - (4) Flush the skin with large amounts of water for at least 20 minutes.
- d. Injected poisons.
  - (1) Maintain the airway and be prepared to provide assisted ventilations.
  - (2) Give supplemental oxygen.
  - (3) Look for gross soft tissue damage ("tracks").
  - (4) Protect the casualty from harming self and others.

*NOTE:* Be prepared to use restraints.

- (5) Transport to the nearest medical treatment facility.

3. Document procedures. (See tasks 081-831-0033 and 081-833-0145.)

**Evaluation Preparation:**

Setup: For training and evaluation, have another Soldier act as the patient.

Brief Soldier: Tell the Soldier that the casualty has an ingested or inhaled poison.

**Performance Measures**

	GO	NO GO
1 Determined the type of poisoning.	_____	_____
2 Initiated treatment for the poisoned casualty.	_____	_____
3 Documented procedures on FMC.	_____	_____

**Evaluation Guidance:** Score each Soldier according to the performance measures. Unless otherwise stated in the task summary, the Soldier must pass all performance measures to be scored GO. If the Soldier fails any steps, show what was done wrong and how to do it correctly.

**References**

**Required**  
DD Form 1380

**Related**  
None

## Change a Sterile Dressing

081-833-0010

**Conditions:** You have a patient with a wound that requires a sterile dressing change. You will need exam gloves, a protective pad, scissors, forceps, sterile gloves, sterile gauze, basin, surgical sponges, face mask, swabs, hand towels, tape, dressings, sterile cleaning solution, adhesive solvent, and forceps. You are not in a CBRN environment.

**Standards:** Change a sterile dressing without violating aseptic technique.

### Performance Steps

1. Verify the medical officer's orders.
2. Identify the patient.
3. Gather the required supplies.
4. Perform a patient care handwash. (See task 081-831-0007.)
5. Explain the procedure to the patient.
6. Prepare the patient.
  - a. Expose the wound by moving the patient's clothing and folding the bed linens away from the wound area, if necessary.
  - b. Position the patient to provide maximum wound exposure.
  - c. Place a protective pad under the patient.
7. Prepare the work area.
  - a. Clear the bedside stand or table.
  - b. Cut the required tape strips and attach them where they are accessible.
8. Put on a mask and exam gloves.
9. Remove the outer dressing.

**WARNING:** Do not peel the tape away from the wound.

- a. Loosen the ends of the tape by peeling toward the wound while supporting the skin around the wound.
  - b. Grasp the edge of the dressing and gently remove it from the wound.
  - c. Note any drainage, color, and odor associated with the dressing.
  - d. If the dressing is grossly saturated, discard the dressing and the gloves in a contaminated waste container otherwise, dispose of in regular trash.
10. Perform a patient care handwash.
  11. Establish a sterile field. (See task 081-833-0007.)
  12. Put on a mask and sterile gloves.
  13. Remove the inner dressings.
    - a. Using forceps, remove the dressings one at a time.
    - b. Note any drainage, color, and odor associated with the dressings.
    - c. Discard the dressings in a contaminated waste container.

d. Drop the forceps on the glove wrap.

14. Assess the wound for:

a. Redness, swelling, foul odor, and/or bleeding.

**CAUTION:** Notify the supervisor if any of the above conditions are present.

b. Drainage that contains blood, serum, or pus (usually yellow but may be blood-tinged, greenish, or brown).

*NOTE:* If drainage is present, inform the medical officer and request orders to irrigate the wound. (See task 081-833-0012.)

15. Clean the wound with sterile gauze soaked with a sterile cleaning solution in accordance with (IAW) medical officers orders and/or local standard operating procedure (SOP).

a. Linear wound.

(1) First stroke. Clean the area directly over the wound with one wipe and discard the gauze.

(2) Second stroke. Clean the skin area on one side next to the wound with one wipe and discard the gauze.

(3) Third stroke. Clean the skin area on the other side next to the wound with one wipe and discard the gauze.

(4) Continue the procedure alternating sides of the wound, working away from the wound until the area is cleaned.

b. Circular wound.

(1) First stroke. Start at the center of the wound, wipe the wounded area with an outward spiral motion, and then discard the gauze.

(2) Second stroke. Clean the skin area next to the wound using an outward spiral motion, approximately one and one half revolutions, and then discard the gauze.

(3) Using successive outward, spiral strokes of approximately one and one half revolutions, clean the entire area around the wound.

16. Change sterile gloves.

17. Remove adhesive from around the wound, if necessary.

a. Using a solvent-soaked cotton tipped applicator or gauze pad, rub gently over the adhesive residue IAW medical officers orders and/or local SOP.

b. Observe the skin for signs of irritation.

18. Apply a sterile dressing.

*NOTE:* If the wound has a drain inserted, cut the dressing halfway through and position it around the drain.

19. Remove sterile gloves and face mask.

20. Secure the dressing with tape.

*NOTE:* Write the date and time the dressing was changed on a piece of tape, initial it, and secure the tape to the dressing.

a. Apply tape to the edge of the dressing with half of the tape on the dressing and the other half on the skin.



b. Write the date and time the dressing was changed on a piece of tape, initial it, and secure the tape to the dressing.

21. Dispose of contaminated materials in appropriate waste container IAW local SOP.

22. Perform a patient care hand-wash.

23. Record the procedure on the appropriate form IAW local SOP.

a. Record the date and time of the dressing change.

b. Document assessment of the wound's appearance.

(1) Type and amount of drainage, if any.

(2) Characteristics of the wound before and after cleaning.

**Evaluation Preparation:**

Setup-If the performance of this task must be simulated for training or evaluation have another Soldier act as the patient. A moulage kit or similar materials may be used to simulate an injury. Apply a dressing to the patient.

Brief Soldier - Tell the Soldier to change the patient's sterile dressing. Tell the Soldier that he is not in a CBRN environment.

**Performance Measures**

GO NO GO

1	Verified the medical officer's orders.	_____	_____
2	Identified the patient.	_____	_____
3	Gathered the required supplies.	_____	_____
4	Performed a patient care handwash.	_____	_____
5	Explained the procedure to the patient.	_____	_____
6	Prepared the patient.	_____	_____
7	Prepared the work area.	_____	_____
8	Put on a mask and exam gloves.	_____	_____
9	Removed the outer dressing.	_____	_____
10	Performed a patient care handwash.	_____	_____
11	Established a sterile field.	_____	_____
12	Put on a mask and sterile gloves.	_____	_____
13	Removed the inner dressings.	_____	_____
14	Assessed the wound for.	_____	_____
15	Cleaned the wound with sterile gauze soaked with a sterile cleaning solution in accordance with (IAW) medical officers orders and/or local standard operating procedure (SOP).	_____	_____
16	Changed sterile gloves.	_____	_____
17	Removed adhesive from around the wound, if necessary.	_____	_____
18	Applied a sterile dressing.	_____	_____

<b>Performance Measures</b>	GO	NO GO
19 Removed sterile gloves and face mask.	_____	_____
20 Secured the dressing with tape.	_____	_____
21 Disposed of contaminated materials in the appropriate waste container IAW local SOP.	_____	_____
22 Performed a patient care handwash.	_____	_____
23 Recorded the procedure on the appropriate form IAW local SOP.	_____	_____

**Evaluation Guidance:** Score each Soldier according to the performance measures. Unless otherwise stated in the task summary, the Soldier must pass all performance measures to be scored GO. If the Soldier fails any steps, show what was done wrong and how to do it correctly.

**References**

**Required**  
None

**Related**  
None

## Initiate a Field Medical Card

**081-831-0033**

**CAUTION:** All body fluids should be considered potentially infectious. Always observe body substance isolation (BSI) precautions by wearing gloves and eye protection as a minimal standard of protection.

**Conditions:** You have treated a casualty for injury or illness and must record the treatment given. You will need DD Form 1380 US Field Medical Card (FMC) and a pen or pencil. You are not in a CBRN environment.

**Standards:** Complete the minimum required blocks.

### Performance Steps

1. Remove the protective sheet from the carbon copy.

*NOTE:* FMCs are issued as a pad of 20 cards, each containing an original card, a carbon protective sheet, and a duplicate sheet.

2. Complete the minimum required blocks.

- a. Block 1. Enter the casualty's name, rank, and complete social security number (SSN). If the casualty is a foreign military person (including prisoners of war), enter their military service number. Enter the casualty's military occupational specialty (MOS) or area of concentration for specialty code. Enter the casualty's religion and sex.

- b. Block 3. Use the figures in the block to show the location of the injury or injuries. Check the appropriate box(es) to describe the casualty's injury or injuries.

*NOTE:* Use only authorized abbreviations. Except for those listed below, however, abbreviations may not be used for diagnostic terminology.

Abr W-Abraded wound.

Cont W-Contused wound.

FC-Fracture (compound) open.

FCC-Fracture (compound) open comminuted.

FS-Fracture (simple) closed.

LW-Lacerated wound.

MW-Multiple wounds.

Pen W-Penetrating wound.

Perf W-Perforating wound.

SL-Slight.

SV-Severe.

2. When more space is needed, attach another DD Form 1380 to the original. Label the second card in the upper right corner "DD Form 1380 #2." It will show the casualty's name, grade, and SSN.

- c. Block 4. Check the appropriate box.

- d. Block 7. Check the yes or no box. Write the dose administered and the date and time that it was administered.

- e. Block 9. Write the information requested. If you need additional space, use Block 14.

f. Block 11. Initial the far right side of the block.

3. Complete the other blocks as time permits. Most blocks are self-explanatory. The following specifics are noted:

a. Block 2. Enter the casualty's unit of assignment and the country of whose armed forces they are a member. Check the armed service of the casualty, that is, A/T = Army, AF/A = Air Force, N/M = Navy, and MC/M = Marine.

b. Block 5. Write in the casualty's pulse rate and the time the pulse was measured.

c. Block 6. Check the yes or no box. If a tourniquet is applied, you should write in the time and date it was applied.

d. Block 8. Write in the time, date, and type of IV solution given. If you need additional space, use Block 9.

e. Block 10. Check the appropriate box. Write the date and time of disposition.

f. Block 12. Write the time and date of the casualty's arrival. Record the casualty's blood pressure, pulse, and respirations in the space provided.

g. Block 13. Document the appropriate comments by the date and time of observation.

h. Block 14. Document the provider's orders by date and time. Record the dose of tetanus administered and the time it was administered. Record the type and dose of antibiotic administered and the time it was administered.

i. Block 15. The signature of the provider or medical officer is written in this block.

j. Block 16. Check the appropriate box and enter the date and time.

k. Block 17. This block will be completed by the Unit Ministry Team. Check the appropriate box of the service provided. The signature of the chaplain providing the service is written in this block.

*NOTE:* As the FMC is the first, and sometimes only, record of treatment of combat casualties, accuracy and thoroughness of information provided is of the utmost importance.

4. Attach the completed FMC to the casualty's uniform by twisting the wire after threading it through the top buttonhole of the uniform. Keep the FMC in plain view.

*NOTE:* Do not attach the FMC to the casualty's body armor as this equipment will be separated from the casualty once they arrive at the medical treatment facility (MTF).

**Evaluation Preparation:**

Setup: For training and evaluation construct a combat casualty scenario. Have another Soldier act as a casualty and have him respond to the Soldier's questions with personal data according to the scenario provided. Ensure the Soldier acting as the casualty has read the scenario thoroughly.

Brief Soldier: Tell the Soldier to complete the FMC by asking appropriate questions of the casualty. Tell the casualty to respond to the Soldier's questions with necessary information according to the scenario provided. To test step 2, you may either have the Soldier complete the required blocks, or you may require the completion of all blocks. After step 2, ask the Soldier what must be done with each copy of the FMC.

**Performance Measures**

	GO	NO GO
1 Removed the protective sheet from the carbon copy.	_____	_____
2 Completed the minimum required blocks (1, 3, 4, 7, 9, and 11).	_____	_____
3 Completed the other blocks as time permitted.	_____	_____
4 Attached the FMC to the top buttonhole of the casualty's uniform.	_____	_____

**Evaluation Guidance:** Score each Soldier according to the performance measures. Unless otherwise stated in the task summary, the Soldier must pass all performance measures to be scored GO. If the Soldier fails any steps, show what was done wrong and how to do it correctly.

**References**

**Required**  
DD Form 1380

**Related**  
None

## Initiate Treatment for Anaphylactic Shock

081-833-0003

**Conditions:** You have a casualty in anaphylactic shock. You will need the casualty's epinephrine autoinjector, (pediatric or adult), stethoscope, sphygmomanometer, bag-valve-mask system, oxygen equipment and DD Form 1380 US Field Medical Card (FMC). You are not in a CBRN environment.

**Standards:** Initiate treatment for anaphylactic shock without causing further injury to the casualty.

*NOTE:* Anaphylactic reactions occur within minutes or even seconds after contact with the substance to which the casualty is allergic. Reactions occur in the skin, respiratory system, and circulatory system.

### Performance Steps

1. Check the casualty for signs and symptoms of anaphylactic shock.

a. Skin.

- (1) Flushed or ashen.
- (2) Burning or itching.
- (3) Edema (swelling), especially in the face, tongue, or airway.
- (4) Urticaria (hives) spreading over the body.
- (5) Marked swelling of the lips and cyanosis about the lips.

b. Respiratory.

- (1) Tightness or pain in the chest.
- (2) Sneezing and coughing.
- (3) Wheezing, stridor, or difficulty in breathing (dyspnea).
- (4) Sputum (may be blood tinged).
- (5) Respiratory failure.

c. Circulatory.

- (1) Weak, rapid pulse.
- (2) Falling blood pressure.
- (3) Hypotension.
- (4) Dizziness or fainting.
- (5) Coma.

2. Open the airway, if necessary. (See task 081-833-0018.)

*NOTE:* In cases of airway obstruction from severe glottic edema, a cricothyroidotomy may be necessary. (See task 081-833-3006.)

3. Administer high concentration oxygen. (See task 081-833-0158.)

4. Administer epinephrine autoinjector.

a. Pediatric autoinjector single dose, 0.15mg, adult autoinjector single dose for greater than 66lbs, 0.3mg.

**NOTE:** Annotate the time of injection on the FMC.

b. Additional epinephrine may be required if anaphylaxis progresses. Additional doses may be administered every 5 to 10 minutes if casualty has been prescribed additional autoinjectors.

5. Provide supportive measures for the treatment of shock, respiratory failure, circulatory collapse, or cardiac arrest.

- a. Position the casualty in the supine position with legs elevated if injuries permit.
- b. Perform rescue breathing, if necessary. (See task 081-831-0048.)
- c. Administer external chest compressions, if necessary. (See task 081-831-0046.)

6. Check the casualty's vital signs every 3 to 5 minutes until the casualty is stable.

7. Record the treatment given on the FMC.

8. Evacuate the casualty, providing supportive measures en route.

**Evaluation Preparation:** None.

<b>Performance Measures</b>	GO	NO GO
1 Checked the casualty for signs and symptoms of anaphylactic shock.	_____	_____
2 Opened the airway, if necessary.	_____	_____
3 Administered oxygen.	_____	_____
4 Assisted with casualty's epinephrine.	_____	_____
5 Provided supportive measures for the treatment of shock, respiratory failure, circulatory collapse, or cardiac arrest.	_____	_____
6 Checked the casualty's vital signs every 3 to 5 minutes until the casualty was stable.	_____	_____
7 Recorded the treatment given on the FMC.	_____	_____
8 Evacuated the casualty and provided supportive measures en route.	_____	_____

**Evaluation Guidance:** Score each Soldier according to the performance measures. Unless otherwise stated in the task summary, the Soldier must pass all performance measures to be scored GO. If the Soldier fails any steps, show what was done wrong and how to do it correctly.

**References**

**Required**  
DD Form 1380

**Related**  
None

## Administer External Chest Compressions

081-831-0046

**CAUTION:** All body fluids should be considered potentially infectious. Always observe body substance isolation (BSI) precautions by wearing gloves and eye protection as a minimal standard of protection.

**Conditions:** You have an unresponsive, apneic and pulseless casualty. You will need a pocket mask with one-way-valve, oxygen, bag-valve-mask, pen and SF 600 (Medical Record-Chronological Record of Medical Care). Another Soldier who is cardiopulmonary resuscitation (CPR) qualified, may arrive and be available to assist you, while you are performing single rescuer CPR. You have taken appropriate body substance isolation precautions and are not in a CBRN environment.

**Standards:** Administer CPR until the pulse is restored or until you are relieved by other competent person(s), are too exhausted to continue, the casualty is pronounced dead by an authorized person, or enemy fire prevents you from continuing until the casualty can be moved behind cover.

### Performance Steps

1. Establish unresponsiveness (gently shake the casualty, asking, "Are you OK?").
  - a. Assess the victim for a response and look for normal or abnormal breathing.

**NOTE:** If there is no response and no breathing or no normal breathing (i.e. only gasping), shout for help.

- b. Tap the casualty's shoulder and shout, "Are you all right?"
  - c. If the casualty is unresponsive, continue with step 2.
  - d. If responsive, continue evaluating the casualty.
2. Activate the Emergency Response System.
3. Check for signs of circulation.
  - a. Attempt to palpate the casualty's carotid pulse (do not take more than 10 seconds).
  - b. If the casualty has a carotid pulse but is not breathing, perform rescue breathing. (See task 081-831-0048.)
  - c. If you do not definitely feel a pulse within 10 seconds, perform 5 cycles of compressions and breaths (30:2 ratio) starting with compressions (C-A-B sequence).

4. Begin chest compressions.

- a. Ensure that the casualty is positioned on a hard, flat surface, in a supine position. Kneel next to the casualty.

**NOTE:** If you suspect the casualty has a head or neck injury, try to keep the head, neck and torso in a line when rolling the casualty to a face up position.

- b. Position yourself at the casualty's side.
  - c. Place the heel of one hand on the center of the casualty's chest on the lower half of the breastbone.

**NOTE:** You may either extend or interlace your fingers but keep your fingers off the casualty's chest.

- d. Put the heel of your other hand on top of the first hand.



*NOTE:* You may either extend or interlace your fingers, but keep your fingers off of the casualty's chest.

e. Straighten your arms and lock your elbows and position your shoulders directly over your hands.

f. Give 30 compressions.

(1) Push hard and fast.

(2) Press down at least 2 inches (5cm) with each compression.

*NOTE:* For each chest compression, make sure you push straight down on the casualty's breast bone. This will require hard work. Adequate depth must be attained for at least 23 of the 30 compressions.

g. Deliver compressions in a smooth fashion at a rate of at least 100 per minute, (i.e. an adequate rate would be 30 compressions in 18 seconds or less).

h. At the end of each compression, make sure you allow the chest to recoil (re-expand) completely.

**CAUTION:** Do not move the casualty while CPR (cardiopulmonary resuscitation) is in progress unless the casualty is in a dangerous environment, or if you cannot perform CPR effectively in the casualty's present position or location.

i. Minimize interruptions.

*NOTE:* Do not remove the heel of your hand from the casualty's chest or reposition your hands between compressions.

5. Open the airway. (See task 081-831-0018.)

*NOTE:* There are two methods of opening the airway to provide breaths, the head tilt-chin lift or the jaw thrust.

6. Give two full rescue breaths.

a. Move quickly to the casualty's head and lean over his mouth.

b. Give two full rescue breaths (each lasting 1 second).

*NOTE:* Deliver air over one second to make the casualty's chest rise.

7. Continue to alternate between chest compressions and ventilations (30:2) until:

a. The casualty is revived.

b. You are too exhausted to continue.

c. You are relieved by another health care provider.

d. The casualty is pronounced dead by an authorized person.

e. A second rescuer states, "I know CPR," and joins you in performing two-rescuer CPR.

8. Limit pulse checks.

9. Perform two-rescuer CPR, if applicable.

*NOTE:* When performing two-rescuer CPR, the rescuers must change position every 2 minutes to avoid fatigue and increase the effectiveness of compressions.

a. Compressor: Give 30 chest compressions at the rate of 100 per minute.

b. Compress the chest at least 2 inches (5cm).

c. Allow the chest to recoil completely after each compression.

- d. Minimize interruptions in compressions, (limit any interruptions to less than 10 seconds).
- e. Count compressions aloud.
- f. Switch duties with the second rescuer every 5 cycles or about 2 minutes, taking less than 5 seconds to switch.
- g. Ventilator: Maintain an open airway. (See task 081-831-0018.)

**CAUTION:** Do not push on the abdomen. If the casualty vomits, turn the casualty on his side, clear the airway (suction), and then continue CPR (If you suspect trauma, logroll the patient as a unit, clear the airway (suction), and then continue CPR).

- h. Give breaths, watching for chest rise and avoiding excessive ventilation.

*NOTE:* If signs of gastric distension are noted, do the following: 1. Recheck and reposition the airway. 2. Watch for rise and fall of the chest. 3. Ventilate the casualty only enough to cause the chest to rise.

*NOTE:* If the casualty is intubated, the ratio of breaths to compressions becomes asynchronous. Give 100 compressions per minute with a ventilation rate of approximately 10 to 12 per minute.

- i. Encourage the first rescuer/compressor to perform compressions that are deep enough and fast enough to allow complete chest recoil between compressions.

- j. Switch duties with the second rescuer every 5 cycles or about 2 minutes taking less than 5 seconds to switch.

- 10. Continue to perform CPR as stated in the task standard.

*NOTE:* The rescuer doing rescue breathing should recheck the carotid pulse every 3 to 5 minutes.

**CAUTION:** During evacuation, CPR or rescue breathing should be continued en route if necessary.

- 11. Continue evaluating the casualty when the pulse and breathing are restored. If the casualty's condition permits, place him in the recovery position. (See task 081-831-0018.)

- 12. Document the procedure on the SF 600.

**Evaluation Preparation:**

Setup: For training and evaluation, a CPR mannequin must be used. Place the mannequin face up on the floor (in the supine position). One-Rescuer, Two-Rescuer or a combination of both (see NOTE after step 14e) can be evaluated. If two Soldiers are involved, they will be designated as "rescuer #1" and "rescuer #2." Rescuer #1 will start in the chest compression position and will be the only one scored during performance of the task. The evaluator will ensure that all aspects of the task are evaluated by indicating whether the pulse is present and when the rescuers would change positions.

Brief Soldier: If two Soldiers are involved, tell them about their roles as rescuer #1 and #2. Ask rescuer #1 on what type of surface the casualty should be positioned. Then, tell the Soldier(s) to perform One-Rescuer or Two-Rescuer CPR as appropriate.

<b>Performance Measures</b>	<b>GO</b>	<b>NO GO</b>
1 Established unresponsiveness.	_____	_____
2 Activated the Emergency Response System.	_____	_____
3 Checked for signs of circulation.	_____	_____

<b>Performance Measures</b>	<b>GO</b>	<b>NO GO</b>
4 Began chest compressions.	_____	_____
5 Opened the airway.	_____	_____
6 Gave two full rescue breaths.	_____	_____
7 Continued to alternate between compressions and ventilations (30:2).	_____	_____
8 Limited pulse checks.	_____	_____
9 Performed two-rescuer CPR if applicable.	_____	_____
10 Continued to perform CPR as stated in the task standard.	_____	_____
11 Continued to evaluate the casualty when the pulse and breathing was restored.	_____	_____
12 Documented the procedure on the SF 600.	_____	_____

**Evaluation Guidance:** Score each Soldier according to the performance measures. Unless otherwise stated in the task summary, the Soldier must pass all performance measures to be scored a GO. If the Soldier fails any steps, show what was done wrong and how to do it correctly.

#### **References**

**Required**  
SF 600

**Related**  
None

## Initiate Treatment for High Altitude Illness

081-833-0035

**Conditions:** You have a casualty requiring treatment for altitude illness. You will need a stethoscope, aspirin, humidified oxygen (O<sub>2</sub>) and O<sub>2</sub> delivery equipment, a DD Form 1380 US Field Medical Card (FMC) and acetazolamide. You are not in a CBRN environment.

**Standards:** Initiate treatment for high altitude illness without further injury to the casualty.

### Performance Steps

1. Recognize the signs and symptoms of various types of high-altitude illness.

a. Acute mountain sickness (AMS).

*NOTE:* AMS is the most common form of altitude sickness and may develop at altitudes as low as 6,500 feet.

- (1) Headache.
- (2) Fatigue.
- (3) Nausea.
- (4) Dyspnea.
- (5) Sleep disturbances.
- (6) Symptoms are aggravated by exertion.

*NOTE:* AMS may evolve into high-altitude pulmonary edema (HAPE), high-altitude cerebral edema (HACE), or both.

b. High-altitude cerebral edema (HACE).

*NOTE:* HACE is believed to be present to a mild degree in all forms of altitude sickness. HACE can occur within 3-5 days after arrival at 9,000 feet, but generally occurs at altitudes above 12,000 feet.

- (1) Gait ataxia is a reliable early warning sign.
- (2) Headache.
- (3) Mental confusion.
- (4) Hallucinations.

**WARNING:** Coma and death may develop within a few hours of the first warning signs of HACE.

(5) Irrational behavior progressing to coma.

c. HAPE.

*NOTE:* HAPE usually develops 24 to 96 hours after rapid ascent above 8,000 feet.

- (1) HAPE is characterized by increasing dyspnea.
- (2) Irritative cough that produces frothy, often bloody sputum.
- (3) Weakness.
- (4) Cyanosis.
- (5) Low-grade fever.
- (6) Tachycardia.
- (7) Fine or coarse rales.

(8) Coma.

**WARNING:** HAPE may worsen rapidly. Coma and death may occur within hours.

2. Initiate prophylactic measures to prevent high-altitude illnesses.

- a. Altitude sickness is best prevented by slow ascent.
- b. Most individuals can ascend to 5,000 feet in 1 day without symptoms.
- c. Above 5,000 feet, a rate of 1,500 feet per day is advisable.

*NOTE:* All rates are variable. A climber should learn how fast he can ascend without developing symptoms. A climbing party should be paced to its slowest member.

d. Although physical fitness enables greater exertion with lower oxygen (O<sub>2</sub>) consumption, it does not protect against any form of altitude sickness.

e. Increased hydration with moderate salt restriction may prevent or diminish symptoms of AMS.

f. Eating frequent, small meals that are high in easily digestible carbohydrates improves altitude tolerance.

g. Acetazolamide 125-250 milligrams (mg) twice a day beginning on day 1 before ascent and continuing for 2 days at maximum altitude is an effective prophylactic for AMS.

3. Manage high-altitude illnesses.

a. AMS.

- (1) Descent, if mission allows, will provide the quickest resolution of symptoms.
- (2) Increase fluid intake.
- (3) Give aspirin or a nonsteroidal anti-inflammatory drug (NSAID) for altitude headache.
- (4) Antiemetic.
- (5) Light diet.
- (6) Avoid any additional ascent or exertion until symptoms resolve.
- (7) Monitor patient for symptom progression to HAPE/HACE.

b. HACE.

- (1) HACE requires immediate descent.
- (2) Give acetazolamide 125 -250 mg twice a day.
- (3) Give dexamethasone 4 mg orally, intramuscularly, or intravenously every 6 hours.

c. HAPE.

(1) Bed rest and oxygen at high altitude may be tried with mild HAPE, depending on mission requirements.

(2) If the condition worsens, immediate descent is essential.

(3) Once descent is accomplished, the patient should be continued on oxygen and managed as with other forms of pulmonary edema.

(4) When promptly treated, patients usually recover from HAPE within 24 to 48 hours after descent.

4. Record all episodes of altitude illness and treatment on a casualty's FMC.
5. Seek the advice and assistance of a medical officer whenever possible.

**Evaluation Preparation:**

This task is best evaluated by verbalization of the steps. Give the Soldier a scenario in which he must manage a high-altitude illness casualty.

<b>Performance Measures</b>	GO	NO GO
1 Recognized the signs and symptoms of various types of high-altitude illness.	_____	_____
2 Initiated prophylactic measures to prevent high-altitude illnesses.	_____	_____
3 Managed high-altitude illnesses.	_____	_____
4 Recorded all episodes of altitude illness and treatment on a casualty's FMC.	_____	_____
5 Sought the advice and assistance of a medical officer whenever possible.	_____	_____

**Evaluation Guidance:** Score each Soldier according to the performance measures in the evaluation guide. Unless otherwise stated in the task summary, the Soldier must pass all performance measures to be scored GO. If the Soldier fails any step, show what was done wrong and how to do it correctly.

**References**

**Required**  
DD Form 1380

**Related**  
None

## Initiate Treatment for a Diabetic Emergency

**81-833-0005**

**Conditions:** You have a patient with a diabetic emergency. You have taken body substance isolation precautions and have performed an initial assessment, focused history, and physical exam. You will need oral glucose, tongue depressors, oxygen, and the patient's medical record or a DD Form 1380 US Field Medical Card (FMC). You are not in a CBRN environment.

**Standards:** Initiate treatment for a diabetic emergency without causing further injury to the patient.

### Performance Steps

1. Identify the signs and symptoms of a diabetic emergency.

a. Hypoglycemia (low blood sugar).

*NOTE:* Hypoglycemia is the most common of all diabetic emergencies.

(1) Rapid onset of altered mental status.

*NOTE:* This occurs after missing a meal, prolonged vomiting or an unusual amount of physical exertion.

(2) Intoxicated appearance, staggering, slurred speech, or unconsciousness.

(3) Elevated heart rate.

(4) Cold, clammy skin.

(5) Hunger.

(6) Seizures.

(7) Uncharacteristic behavior.

(8) Anxiety.

(9) Combativeness.

b. Hyperglycemia (high blood sugar).

(1) Slow onset.

(2) Warm, red, dry skin.

(3) Sweet, fruity breath odor (acetone).

(4) Deep, rapid breathing.

(5) Dry mouth.

(6) Intense thirst.

(7) Abdominal pain.

(8) Nausea and vomiting.

2. Administer the appropriate treatment.

*NOTE:* If you are unsure whether the patient has hyperglycemia or hypoglycemia, it is safer to treat the patient for hypoglycemia.

a. Hypoglycemia.

(1) If conscious, administer oral glucose IAW local protocol.

*NOTE:* Give it only if the patient has a history of diabetes, the patient has an altered mental status, and the patient is awake enough to swallow.

(a) Apply glucose to a tongue depressor and place it in the patient's mouth between the cheek and gum.

(b) Or if the patient is able, let the patient squeeze the glucose from the tube directly into his mouth.

(2) Monitor the patient for complications.

(3) Assess vital signs.

(4) If unconscious-

(a) Secure the airway and administer oxygen.

(b) Assess vital signs.

(c) Place the patient in the recovery position.

(d) Transport to the nearest medical treatment facility.

b. Hyperglycemia.

(1) Maintain an open airway and administer oxygen.

(2) Assess vital signs.

(3) Place the patient on a cardiac monitor, if available.

(4) Transport to the nearest medical treatment facility.

3. Document all treatment given on FMC.

*NOTE:* Document the patient's mental status using the alert, verbal, painful, unresponsive (AVPU) scale and vital signs every 5 minutes. A change in mental status may indicate an alteration in the patient's blood sugar level.

**Evaluation Preparation:**

Setup: For training and evaluation, have another Soldier act as the patient and exhibit signs and symptoms of hyperglycemia or hypoglycemia.

Brief Soldier: Tell the Soldier to state the signs and symptoms of hypoglycemia and then initiate treatment.

<b>Performance Measures</b>	GO	NO GO
1 Identified the type of diabetic emergency (hypoglycemia or hyperglycemia).	_____	_____
2 Administered appropriate treatment for	_____	_____
3 Documented all treatment given on FMC.	_____	_____

**Evaluation Guidance:** Score each Soldier according to the performance measures. Unless otherwise stated in the task summary, the Soldier must pass all performance measures to be scored GO. If the Soldier fails any steps, show what was done wrong and how to do it correctly.

**References**

**Required**  
DD Form 1380

**Related**  
None



**Perform a Medical Patient Assessment****081-833-0156**

**Conditions:** You have a patient with a complaint that is medical in nature and no significant mechanism of injury. You will need a sphygmomanometer, stethoscope, thermometer, and airway adjuncts. You are not in a CBRN environment.

**Standards:** Perform a medical patient assessment without causing further injury.

**Performance Steps**

1. Take body substance isolation precautions.
2. Perform scene size-up.
  - a. Determine the safest route to access the patient.
  - b. Determine the mechanism of injury/nature of illness.
  - c. Determine the number of patients.
  - d. Request additional help if necessary.
  - e. Consider stabilization of the spine.
3. Perform an Initial Assessment.
  - a. Form a general impression of the patient and the patient's environment.
  - b. Assess the patient's mental status using the Alert, Verbal, Pain, Unresponsive (AVPU).
    - (1) A-Alert and oriented.
    - (2) V-Responsive to verbal stimuli.
    - (3) P-Responsive to painful stimuli.
    - (4) U-Unresponsive.
  - c. Determine the chief complaint/apparent life-threatening condition.
  - d. Assess the airway.
    - (1) Perform an appropriate maneuver to open and maintain the airway if necessary. (See task 081-831-0018.)
    - (2) Insert an appropriate airway adjunct, if necessary. (See tasks 081-833-0016, 081-833-0142, and 081-833-0169. Also if skill level 30, See task 081-830-3016.)
  - e. Assess breathing.
    - (1) Determine the rate, rhythm, and quality of breathing.
    - (2) Administer oxygen if necessary using the appropriate delivery device. (See tasks 081-833-0158 and 081-831-0048.)
  - f. Assess circulation.
    - (1) Check skin color and temperature.
    - (2) Assess the pulse for rhythm and force.
      - (a) Check the radial pulse in adults.
      - (b) Check the radial pulse and capillary refill in children under 6 years old.

(c) Check the brachial pulse and capillary refill in infants.

(3) Check for major bleeding.

(4) Control major bleeding. (See tasks 081-833-0161 and 081-833-0046.)

(5) Treat for shock. (See task 081-833-0047.)

g. Identify priority patients and make a transport decision (load and go or stay and play).

*NOTE:* High priority conditions that require immediate transport include poor general impression, unresponsive, responsive but not following commands, difficulty breathing, shock, complicated childbirth, chest pain with systolic blood pressure less than 100, uncontrolled bleeding, and severe pain.

4. Conduct a rapid physical exam if the patient is unconscious. Inspect each of the following areas for deformities, contusions, abrasions, punctures or penetration, burns, tenderness, lacerations, swelling (DCAP-BTLS).

a. Assess the head.

b. Assess the neck.

c. Assess the chest.

d. Assess the abdomen.

e. Assess the pelvis.

f. Assess the extremities.

g. Assess the posterior.

5. Gather a SAMPLE history from the patient.

a. Signs and symptoms. Gather history of the present illness (OPQRST) from the patient.

(1) RESPIRATORY.

(a) Onset-When did it begin?

(b) Provocation - What were you doing when this came on?

(c) Quality-Can you describe the feeling you have?

(d) Radiation-Does the feeling seem to spread to any other part of your body? Do you have pain or discomfort anywhere else in your body?

(e) Severity On a scale of 1 to 10, how bad is your breathing trouble (10 is worst, 1 is best)?

(f) Time How long have you had this feeling?

(g) Interventions-Have you taken any medication to help you breathe? Did it help?

(2) CARDIAC.

(a) Onset-When did it begin?

(b) Provocation-What were you doing when this came on?

(c) Quality-Can you describe the feeling you have?

(d) Radiation-Does the feeling seem to spread to any other part of your body? Do you have pain or discomfort anywhere else in your body?

(e) Severity-On a scale of 1 to 10, how bad is your breathing trouble (10 is worst, 1 is best)?

(f) Time-How long have you had this feeling?

(g) Interventions-Have you taken any medication to help you? Did it help?

(3) ALTERED MENTAL STATUS.

(a) Description of the episode Can you tell me what happened? How did the episode occur?

(b) Onset-How long ago did it occur?

(c) Duration-How long did it last?

(d) Associated symptoms-Was the patient sick or complaining of not feeling well before this happened?

(e) Evidence of trauma Was the patient involved in falls or accidents recently?

(f) Interventions-Has the patient taken anything to help with this problem? Did it help?

(g) Seizures-Did the patient have a seizure?

(h) Fever - Did the patient have a fever? What was the patient's temperature?

(4) ALLERGIC REACTION.

(a) History of allergies-Do you have any allergies?

(b) What were you exposed to-Is there any chance that you were exposed to something that you may be allergic to?

(c) How were you exposed-How did you come into contact with \_\_\_\_\_ (whatever the patient is allergic to)?

(d) Effects - What kind of symptoms are you having? How long after you were exposed did the symptoms start?

(e) Progression-How long after you were exposed did the symptoms start? Are they worse now than they were before?

(f) Interventions-Have you taken anything to help? Did it help?

(5) POISONING/OVERDOSE.

(a) Substance-What substance was involved?

(b) When did you ingest/become exposed-When did the exposure/ingestion occur?

(c) How much did you ingest-How much did the patient ingest?

(d) Over what time period-Over how long a period did the ingestion occur?

(e) Interventions-What interventions did the family or bystanders take?

(f) Estimated weight-What is the patient's estimated weight?

(6) ENVIRONMENTAL EMERGENCY.

(a) Source-What caused the injury?

(b) Environment-Where did the injury occur?

(c) Duration-How long were you exposed?

(d) Loss of consciousness-Did you lose consciousness at any time?

(e) Effects (general or local)-What signs and symptoms are you having? What effect did being exposed have on the patient?

(7) OBSTETRICS.

(a) Are you pregnant?

(b) How long have you been pregnant?

(c) Are you having pain or contractions?

(d) Are you bleeding? Are you having any discharge?

(e) Do you feel the need to push?

(f) When was your last menstrual period?

(8) BEHAVIORAL.

(a) How do you feel?

(b) Determine suicidal tendencies-Do you have a plan to hurt yourself or anyone else?

(c) Is the patient a threat to self or others?

(d) Is there a medical problem?

(e) Interventions?

b. Allergies.

c. Medications.

d. Past pertinent history.

e. Last oral intake.

f. Event(s) leading to present illness.

6. Perform a focused physical examination on the affected body part/system.

7. Obtain baseline vital signs. (See tasks 081-831-0013, 081-831-0011, 081-831-0010, and 081-831-0012.)

8. Provide medication, interventions, and treatment as needed. (See tasks 081-831-0035, 081-833-0103, 081-833-0116, 081-833-0143, 081-833-0144, 081-833-0159, 081-833-0160, 081-833-0163, 081-833-0166, 081-833-0054, 081-831-0038, 081-831-0039, 081-833-0031, 081-833-0073, and 081-833-3206.)

9. Reevaluate the transport decision.

10. Consider completing a detailed physical examination.

11. Perform Ongoing Assessment.

a. Repeat the initial assessment.

b. Repeat vital signs.

c. Repeat the focused assessment regarding the patient's complaint or injuries.

**Evaluation Preparation:** None.

<b>Performance Measures</b>	GO	NO GO
1 Took BSI precautions.	_____	_____
2 Performed a scene size-up.	_____	_____
3 Performed an Initial Assessment.	_____	_____
4 Conducted a rapid physical exam if the patient was unconscious.	_____	_____
5 Gathered a SAMPLE history from the patient.	_____	_____
6 Performed a focused physical examination on the affected body part/system.	_____	_____
7 Obtained baseline vital signs.	_____	_____
8 Provided medication, interventions and treatment.	_____	_____
9 Reevaluated the transport decision.	_____	_____
10 Considered completing a detailed physical examination.	_____	_____
11 Performed Ongoing Assessment.	_____	_____

**Evaluation Guidance:** Score each Soldier according to the performance measures in the evaluation guide. Unless otherwise stated in the task summary, the Soldier must pass all performance measures to be scored GO. If the Soldier fails any step, show what was done wrong and how to do it correctly.

**References**

**Required**  
None

**Related**  
None

## Initiate Treatment for a Near Drowning Casualty

081-833-0009

**Conditions:** You have a near drowning casualty that requires treatment. You will need a medical aid bag, buoyant backboard, automated external defibrillator (AED), oxygen, oxygen administration equipment, a blanket and a DD Form 1380 US Field Medical Card (FMC). You are not in a CBRN environment.

**Standards:** Initiate treatment of a near drowning casualty without causing further injury to the casualty.

### Performance Steps

1. Ensure the safety of all rescuers, including yourself, before any water rescue can begin.
  2. Recognize the signs and symptoms of near drowning.
    - a. Change in level of consciousness.
    - b. Restlessness.
    - c. Chest pain.
    - d. Rales, rhonchi, or wheezing.
    - e. Vomiting.
    - f. Cyanosis.
    - g. Signs of shock (common in near-drowning). When shock is present, try to determine if shock is hypovolemic, hypoxic, or neurogenic spinal injury.
    - h. Pink froth from nose and mouth.
  3. Perform prehospital management for near drowning and aspiration.
    - a. Raise the casualty to the surface and remove him from the water as soon as possible.
- NOTE:* Cervical or spinal injuries are always a primary concern. You must assume that the casualty has a spinal injury and treat accordingly. This means that initial resuscitation and spine immobilization must occur while the casualty is still in the water. (See task 081-833-0176.)
- b. Perform an initial assessment. Evaluate the need for suction, ventilation, O<sub>2</sub> administration and basic life support (BLS), if needed.
    - c. Float a buoyant backboard under the casualty as ventilation is continued.
    - d. Secure the trunk and neck to the backboard to eliminate spine motion. Do not remove the casualty from the water until this is done.
    - e. Remove casualty from water.
    - f. Place the casualty in the lateral recumbent position, with the backboard in place.
    - g. Cover the casualty with a blanket.
    - h. Administer oxygen by mask.
  4. Perform a trauma casualty assessment. (See task 081-833-0155.)
- NOTE:* All victims should be hospitalized for at least 24 hours for observation. Common complications of near drowning are respiratory failure and circulatory collapse.
5. Record all treatment on the FMC.
  6. Evacuate the casualty.

**Evaluation Preparation:** None.

<b>Performance Measures</b>	GO	NO GO
1 Ensured the safety of all rescuers, including yourself, before any water rescue began.	_____	_____
2 Recognized the signs and symptoms of near drowning.	_____	_____
3 Performed prehospital management for near drowning or aspiration.	_____	_____
4 Performed a trauma casualty assessment.	_____	_____
5 Recorded all treatment on the FMC.	_____	_____
6 Evacuated the casualty.	_____	_____

**Evaluation Guidance:** Score each Soldier according to the performance measures. Unless otherwise stated in the task summary, the Soldier must pass all performance measures to be scored GO. If the Soldier fails any steps, show what was done wrong and how to do it correctly.

**References**

**Required**  
DD Form 1380

**Related**  
None

## **Initiate Treatment for an Allergic Reaction**

**081-833-0013**

**Conditions:** You have a patient demonstrating signs and symptoms of an allergic reaction. You will need a sphygmomanometer and a stethoscope. You are not in a CBRN environment.

**Standards:** Initiate treatment on a patient with an allergic reaction without causing further injury.

### **Performance Steps**

1. Recognize the causes of allergic reactions.
  - a. Medications (penicillin).
  - b. Insect bites (bee stings).
  - c. Pollen.
  - d. Foods (peanuts and shellfish).
  - e. Latex.
2. Recognize the early manifestations of an allergic or anaphylactic reaction.
  - a. Skin.
    - (1) Flushing.
    - (2) Urticaria (hives).
    - (3) Swelling of face (especially eyes and lips), hands, feet, neck.
  - b. Respiratory.
    - (1) Tightness in throat and chest.
    - (2) Cough.
    - (3) Rapid, labored noisy breathing.
    - (4) Stridor (harsh, high pitched sound during inspiration).
  - c. Generalized feelings.
    - (1) Itchy, watery eyes.
    - (2) Headache.
    - (3) Runny nose.
3. Recognize the signs of anaphylactic shock. (See task 081-833-0003.)
4. Initiate treatment for allergic reactions.
  - a. Perform initial assessment ABCs (treat any life-threatening conditions).
  - b. Perform a focused history and physical exam.
  - c. Assess baseline vital signs and SAMPLE history.
5. Evacuate the patient to the nearest medical treatment facility (MTF).

### **Evaluation Preparation:**

Setup: This task is best evaluated by verbalization of the steps.

Brief Soldier: Give the Soldier a scenario in which they must initiate treatment of an allergic reaction.



**Performance Measures**

	GO	NO GO
1 Recognized the causes of allergic reactions.	_____	_____
2 Recognized the early manifestations of an allergic reaction.	_____	_____
3 Recognized the signs of anaphylactic shock. (See task 081-833-0003.)	_____	_____
4 Initiated treatment of the allergic reaction.	_____	_____
5 Evacuated the patient to the nearest MTF.	_____	_____

**Evaluation Guidance:** Score each Soldier according to the performance measures. Unless otherwise stated in the task summary, a Soldier must pass all performance measures to be scored GO. If a Soldier fails any step, show what was done wrong and how to do it correctly.

**References**

**Required**  
None

**Related**  
None

## Operate an Automated External Defibrillator

081-833-0014

**Conditions:** You have a patient in ventricular fibrillation or pulseless ventricular tachycardia and is receiving basic cardiac life support from a single rescuer. You will need an automated external defibrillator (AED), an airway adjunct, a bag-valve-mask (BVM) system and oxygen. You are not in a CBRN environment.

**Standards:** Operate an AED without causing further injury to the patient.

### Performance Steps

1. Take appropriate body substance isolation (BSI) precautions.
2. Briefly question the rescuer about the arrest event.
  - a. How long has the patient been in arrest?
  - b. How long has CPR been in progress?
  - c. Do you know two man CPR?
3. Direct rescuer to stop CPR.
4. Determine need for an AED.
  - a. Is patient unresponsive to verbal and painful stimuli?
  - b. Is patient apneic?
  - c. Is patient pulseless?
5. Direct rescuer to continue CPR.
6. Turn on AED.

**WARNING:** Do not attach child pads to an adult patient.

7. Attach the pads to patient's bare chest.

**NOTE:** Follow the AED manufacturer's guidelines on attaching pads to patient and turning on the machine.

a. The sternum pad is placed on the right upper border of the sternum on the anterior chest wall. The top edge should be just below the clavicle. This is the negative electrode.

b. The apex pad is placed over the left lower ribs at the anterior axillary line. This is the positive electrode.

8. Direct rescuer to stop CPR.

**WARNING:** The AED will analyze any detectable rhythm. If anyone is touching the patient, the machine may not recommend a shock.

9. Ensure everyone and everything is clear of the patient.
  - a. Gives the order "All Clear".
  - b. Visually checks to ensure no one is in contact with the patient.
  - c. Visually checks to ensure nothing is in direct contact with the electrodes such as IV lines, monitor wires or a bed frame.
10. Initiate analysis of the rhythm.

*NOTE:* Certain AEDs have an analyze button that will need to be pressed to analyze the rhythm and others will analyze automatically. Refer to the manufacturer's instructions for the type of AED used.

**CAUTION:** Do not defibrillate if anyone is touching the patient or the patient is wet (dry the patient), touching metal, (move the patient), or wearing a medication patch (remove the patch with a gloved hand).

11. Press the shock button if AED indicates shock is advised.
  - a. Gives the order "All Clear."
  - b. Visually checks to ensure no one is in direct contact with the patient.
  - c. Visually checks to ensure no one is in direct contact with any electrically conductive material touching the patient such as IV lines, monitor cables or a bed frame.
12. Direct resumption of CPR.
13. Gather additional information about the arrest event.
14. Confirm effectiveness of CPR.
  - a. Check pulse during compressions.
  - b. Look for rise and fall of chest during ventilations.
15. Inserts or direct insertion of a simple airway adjunct.

*NOTE:* Steps 15 and 16 can be done at any time during the task.

16. Connect oxygen to BVM and turn flow meter to 15 liters per minute (lpm).
17. Ventilate or direct assistant to resume ventilations on the patient.
18. Ensure CPR continues without unnecessary interruptions.
19. Reanalyze rhythm after a full cycle of CPR, (approximately 2 minutes), ensure patient is clear.
20. Repeat defibrillator steps 8-12.
21. Transport the patient to a higher level of medical care.

*NOTE:* Verbalize transportation of the patient.

**Evaluation Preparation:** None.

<b>Performance Measures</b>	GO	NO GO
1 Took body substance isolation precautions.	_____	_____
2 Questioned rescuer briefly about arrest event.	_____	_____
3 Directed rescuer to stop CPR.	_____	_____
4 Determined need for AED.	_____	_____
5 Directed rescuer to resume CPR.	_____	_____
6 Turned on AED power.	_____	_____
7 Attached pads to patient's bare chest.	_____	_____
8 Directed rescuer to stop CPR.	_____	_____

<b>Performance Measures</b>	GO	NO GO
9 Ensured patient was clear.	_____	_____
10 Analyzed rythm.	_____	_____
11 Delivered shock ensuring patient was clear.	_____	_____
12 Directed resumption of CPR.	_____	_____
13 Gathered additional information about arrest event.	_____	_____
14 Confirmed effectiveness of CPR.	_____	_____
15 Inserted or directed insertion of an airway adjunct.	_____	_____
16 Connected oxygen to BVM and adjusted flow meter to 15 lpm to ensure high concentration of oxygen delivered to patient.	_____	_____
17 Resumed ventilation or directed ventilation of patient.	_____	_____
18 Ensured CPR continued without unnecessary interruptions.	_____	_____
19 Reanalyzed patient rhythm after full cycle of CPR, (approximatley 2 minutes), ensuring patient is clear.	_____	_____
20 Repeated defibrillator sequence steps.	_____	_____
21 Transported (verbalized) patient.	_____	_____

**Evaluation Guidance:** Score each Soldier according to the performance measures in the evaluation guide. Unless otherwise stated in the task summary, the Soldier must pass all performance measure to be scored a GO. If the Soldier fails any step, show what was done wrong and how to do it correctly.

**References**

**Required**  
None

**Related**  
None

**Put on Sterile Gloves****081-831-0008**

**Conditions:** You need to put on sterile gloves. You will need handwashing facilities, sterile gloves, and a flat, clean, dry surface. You are not in a CBRN environment.

**Standards:** Put on sterile gloves without contaminating self or the gloves.

**Performance Steps**

1. Select and inspect the package.
    - a. Select the proper size of glove.
    - b. Inspect the package for possible contamination.
      - (1) Water spots.
      - (2) Moisture.
      - (3) Tears.
      - (4) Any other evidence that the package is not sterile.
  2. Perform a patient care hand wash. (See task 081-831-0007.)
  3. Open the sterile package.
    - a. Place the package on a flat, clean, dry surface in the area where the gloves are to be worn.
    - b. Peel the outer wrapper open to completely expose the inner package.
  4. Position the inner package.
    - a. Remove the inner package touching only the folded side of the wrapper.
    - b. Position the package so that the cuff end is nearest you.
  5. Unfold the inner package.
    - a. Grasp the lower corner of the package.
    - b. Open the package to a fully flat position without touching the gloves.
  6. Expose both gloves.
    - a. Grasp the lower corners on the folder.
    - b. Pull gently to the side without touching the gloves.
  7. Put on the first glove.
    - a. Grasp the cuff at the folded edge and remove it from the wrapper.
    - b. Step away from the table or tray.
    - c. Keeping your hands above the waist, insert the fingers of the other hand into the glove.
    - d. Pull the glove on touching only the exposed inner surface of the glove.
- NOTE:* If there is difficulty in getting your fingers fully fitted into the glove fingers; make the adjustment after both gloves are on.
8. Put on the second glove.
    - a. Insert the fingertips of the gloved hand under the edge of the folded over cuff.

*NOTE:* You may keep the gloved thumb up and away from the cuff area or you may insert it under the edge of the folded over cuff with the fingertips.

b. Keeping your hands above the waist, insert the fingers of the ungloved hand into the glove.

c. Pull the glove on.

d. Do not contaminate either glove.

9. Adjust the gloves to fit properly.

a. Grasp and pick up the glove surfaces on the individual fingers to adjust them.

b. Pick up the palm surfaces and work your fingers and hands into the gloves.

c. Interlock the gloved fingers and work the gloved hands until the gloves are firmly on the fingers.

*NOTE:* If either glove tears while putting them on or adjusting the gloves, remove both gloves and repeat the procedure.

**Evaluation Preparation:**

Set-up: If performance of this task must be simulated for training and evaluation, the same gloves may be used repeatedly as long as they are properly rewrapped after each use. You may give the Soldier a torn or moist glove package to test step 1.

*NOTE:* If the Soldier does not know his glove size, have several different sizes available to try on to determine the correct size.

Brief Soldier: Tell the Soldier to put on the sterile gloves. Tell the Soldier that they are not in a CBRN environment.

**Performance Measures**

1 Selected and inspected the package.

2 Performed a patient care hand wash.

3 Opened the sterile package.

4 Positioned the inner package.

5 Unfolded the inner package.

6 Exposed both gloves.

7 Put on the first glove without contaminating.

8 Put on the second glove without contaminating.

9 Adjusted the gloves to fit properly.

GO NO GO

_____	_____
_____	_____
_____	_____
_____	_____
_____	_____
_____	_____
_____	_____
_____	_____
_____	_____
_____	_____

**Evaluation Guidance:** Score each Soldier according to the performance measures. Unless otherwise stated in the task summary, the Soldier must pass all performance measures to be scored GO. If the Soldier fails any steps, show what was done wrong and how to do it correctly.

**References**

**Required**  
None

**Related**  
None

## Manage a Seizing Patient

**081-833-0002**

**Conditions:** You have a seizing patient requiring management. You will need padding materials, oxygen, suction equipment, non-rebreather or bag-valve-mask, pen and SF 600 (Medical Record-Chronological Record of Medical Care). You have performed a patient care hand wash and taken appropriate body substance isolation precautions. You are not in a CBRN environment.

**Standards:** Complete all steps to manage a seizing patient without causing unnecessary injury to the patient.

### Performance Steps

1. Identify the type of seizure based upon the following signs and symptoms.
    - a. Petit mal.
      - (1) Brief loss of concentration or awareness without loss of motor tone.
      - (2) Lip smacking or eye blinking.
      - (3) Occurs mainly in children and is rarely an emergency.
    - b. Grand mal (generalized).
      - (1) May be preceded by an aura.
      - (2) Has two phases.
        - (a) Tonic/Clonic Phase--characterized by rigidity and stiffening of the body, drooling and occasional cyanosis around the face and lips.
        - (b) Postictal Phase--begins when convulsions stop. The patient may regain consciousness and enter a state of drowsiness and confusion or remain unconscious for several hours.
        - (3) May involve incontinence, biting of the tongue (rare), cyanosis or mental confusion.
    - c. Status Epilepticus.
      - (1) Two or more seizures without an intervening period of consciousness or a seizure lasting more than 30 minutes.
      - (2) A medical emergency. If untreated it may lead to:
 

*NOTE:* Mentally note the aspects of seizure activity for recording after the seizure.

        - (a) Aspiration of secretions.
        - (b) Cerebral or tissue hypoxia.
        - (c) Brain damage or death.
        - (d) Fractures of long bones.
        - (e) Head trauma.
        - (f) Injured tongue from biting.
- CAUTION:** Never place anything in the mouth of a seizing patient.
2. Maintain the airway of a patient exhibiting tonic-clonic movement.
  3. Place the patient on his side if possible.

- a. Observe the patient to prevent aspiration and suffocation.

**CAUTION:** Do not elevate the patient's head and do not restrain the patient's limbs during seizures.

- b. Place patient on high-flow oxygen at 15 L/min via non-rebreathing mask if available.
- 4. Prevent injury to tissue and bones by padding or removing objects on which the patient may injure himself.
- 5. Manage the patient after the convulsive state has ended.
  - a. Place the patient on his side if necessary.
  - b. Continue to maintain the patient's airway.

*NOTE:* A patient who has just had a grand mal seizure will sometimes drool and will usually be drowsy so you must be prepared to suction if equipment is available.

- c. Administer supplemental oxygen, if available, via non-rebreather mask or bag-valve-mask if not available earlier.

**CAUTION:** Sudden, loud noises may cause another seizure.

- d. If possible, place the patient in a quiet, reassuring atmosphere.
- 6. Record the seizure activity on SF 600.
  - a. Duration of seizure.
  - b. Presence of cyanosis, breathing difficulty or apnea.
  - c. Level of consciousness before, during and after the seizure.
  - d. Whether preceded by an aura, (ask patient).
  - e. Muscles involved.
  - f. Type of motor activity.
  - g. Incontinence.
  - h. Eye movement.
  - i. Previous history of seizures, head trauma and/or drug or alcohol abuse.

*NOTE:* If the seizure is witnessed, be sure to ask if they saw the patient fall, how he landed, how the patient was moving during the seizure and how long the seizure lasted.

- 7. Evacuate the patient on his side in the recovery position.
- 8. Do not cause further injury to the patient.

**Evaluation Preparation:**

Setup: For training and evaluation, have another Soldier act as a patient.

**Performance Measures**

	GO	NO GO
1 Identified the type of seizure.	_____	_____
2 Maintained the airway of a patient exhibiting tonic-clonic movement.	_____	_____
3 Placed patient on his side, if possible.	_____	_____
4 Prevented injury to tissue and bones by padding or removing objects on	_____	_____



**Performance Measures**

GO NO GO

which the patient may injure himself.

5 Managed the patient after the seizure ended.

\_\_\_\_\_

6 Recorded the seizure activity on SF 600.

\_\_\_\_\_

7 Evacuated the patient.

\_\_\_\_\_

8 Did not cause further injury to the patient.

\_\_\_\_\_

**Evaluation Guidance:** Score each Soldier according to the performance measures. Unless otherwise stated in the task summary, the Soldier must pass all performance measured to be scored a GO. If the Soldier fails any steps, show what was done wrong and how to do it correctly.

**References**

**Required**  
SF 600

**Related**  
None

## Initiate Treatment for Chest Pain

081-833-0011

**Conditions:** You have a conscious patient who is complaining of chest pain. You have taken body substance isolation precautions (BSI). You have performed the initial assessment and the focused history and physical exam. You will need an oxygen tank setup, non-rebreather mask, a stethoscope, sphygmomanometer, pulse oximetry, alcohol swabs, pen, SF 600 (Medical Record-Chronological Record of Medical Care), and you are not in a CBRN environment.

**Standards:** Complete all steps to manage a patient with a suspected cardiac emergency without causing further injury to the patient.

### Performance Steps

1. Identify signs and symptoms of possible cardiac emergency or compromise.

a. Altered mental status.

(1) Unresponsiveness.

(2) Sleepiness.

(3) Head-bobbing.

(4) Agitation.

(5) Anxiety.

b. Chief complaint of chest, neck, back, or jaw pain/discomfort.

*NOTE:* A patient with a clenched fist over their chest is a sign of chest pain or discomfort.

c. Severe difficulty breathing, including inability to speak only a few words per sentence.

d. Poor skin color, including pale grey or cyanotic (blue); cool, moist skin.

e. Abnormally slow or fast respiratory rates.

f. Abnormal pulse (arrhythmia).

(1) Bradycardia (less than 60 beats per minute).

(2) Tachycardia (greater than 100 beats per minute).

g. Abnormal blood pressure.

(1) Hypotensive (systolic pressure less than 90 mmHg).

(2) Hypertensive (systolic pressure greater than 150 mmHg).

h. Shallow respirations with any respiratory rate.

2. Administer the appropriate treatment.

a. Place patient in position of comfort.

*NOTE:* Position of comfort is generally the Fowler's position.

b. Apply high concentration oxygen via a non-rebreather mask at 15 lpm (liters per minute).

**CAUTION:** Don't forget to ask the patient what their blood pressure is normally before you take your reading. This will help you know what to expect and be able to determine if it is normal for the patient.

c. Obtain baseline vital signs.

**WARNING:** Prior to assisting patient with their prescribed medication of nitroglycerin, contact medical direction and give the patient's vital signs, especially the systolic blood pressure reading. Nitroglycerin is contraindicated for patient(s) whose systolic blood pressure is less than 100 mmHg and/or who is taking medication to treat erectile dysfunction.

d. Assist the patient in taking their nitroglycerin, if available and IAW local protocol.

*NOTE:* You must call medical control for approval to assist with the patient's prescribed nitroglycerin. All signs and symptoms of chest pain/cardiac compromise must be in place before assisting the patient with their medication.

- (1) Check the six rights.
- (2) Remove the oxygen mask.
- (3) Ask the patient to open their mouth and lift their tongue.

**CAUTION:** Avoid contact with Nitroglycerin and your bare skin. The vasodilation affects could cause unconsciousness.

- (4) Place the tablet or spray (if using mist) under the tongue with a gloved hand.
- (5) Have the patient close their mouth and hold the tablet under their tongue (sublingually) and allow it to dissolve completely.

*NOTE:* Inform the patient that nitroglycerin can produce a stinging or burning sensation under the tongue. It may also cause them to experience a headache due to the rapid vasodilation that occurs.

- (6) Replace the oxygen mask.
- (7) Recheck the blood pressure within 2 minutes.

*NOTE:* If the systolic blood pressure falls below 100 mmHg, treat the patient for shock and transport immediately. You might want to have an ALS (advanced life support) team meet you in route to the nearest medical facility.

e. If the patient experiences no relief from chest pain, nitroglycerin can be repeated up to three tablets provided the systolic blood pressure remains above 100 mmHg and approval is given by medical control.

3. Transport promptly to the nearest medical facility.
4. Perform an ongoing assessment while enroute.
5. Document all interventions on a SF 600.

**Evaluation Preparation:**

Setup: Have one Soldier be the patient while the Soldier being evaluated administers treatment. Tell the Soldier who is acting as the patient the signs and symptoms he should exhibit and how to answer the questions asked by the Soldier being tested.

<b>Performance Measures</b>	GO	NO GO
1 Identified the signs and symptoms of cardiac emergency or compromise.	_____	_____
2 Administered the appropriate treatment.	_____	_____
3 Transported promptly to the nearest medical facility.	_____	_____
4 Performed an ongoing assessment while enroute.	_____	_____

**Performance Measures**

GO

NO GO

5 Documented all interventions on a SF 600.

\_\_\_\_\_

\_\_\_\_\_

**Evaluation Guidance:** Score each Soldier according to the performance measures in the evaluation guide. Unless otherwise stated in the task summary, the Soldier must pass all performance measures to be scored GO. If the Soldier fails any step, show what was done wrong and how to do it correctly.

**References**

**Required**  
SF 600

**Related**  
None

**Subject Area 3: Trauma Treatment**  
**Apply a Combat Application Tourniquet**

**081-833-0065**

**CAUTION:** All body fluids should be considered potentially infectious. Always observe body substance isolation (BSI) precautions by wearing gloves and eye protection as a minimal standard of protection.

**Conditions:** You encounter a casualty who is hemorrhaging from an extremity. You will need a clean cloth or sterile dressing, combat application tourniquet (C-A-T), marker, pen, tape and a DD Form 1380 US Field Medical Card (FMC). You are not in a CBRN environment.

**Standards:** Apply a combat application tourniquet (C-A-T) to control bleeding from the extremity without causing further injury to the casualty.

**Performance Steps**

1. Expose the wound.
2. Place combat application tourniquet (C-A-T), 2-3 inches above the wound on the injured extremity.
3. Pull the free end of the self-adhering band through the buckle and route through the friction adapter buckle.

**NOTE:** On an arm wound, it is not necessary to route the strap through the friction adapter.

4. Pull the self-adhering band tight around the extremity and fasten it back on itself as tightly as possible.
5. Twist the windlass until the bleeding stops.
6. Lock the windlass in place within the windlass clip.
7. Secure the windlass with the windlass strap.
8. Assess for absence of a distal pulse.
9. Place a "T" and the time of the application on the casualty's forehead with a marker.
10. Secure the C-A-T in place with tape.
11. Record the treatment on a FMC.

**Evaluation Preparation:**

**Setup:** For training and evaluation, have another Soldier act as the casualty.

**Brief the Soldier:** Tell the Soldier to apply a combat application tourniquet (C-A-T) to the casualty's extremity.

Once the C-A-T has been applied and the windlass device has been tightened, tell the Soldier that the bleeding has stopped. Tell the casualty not to assist the Soldier in any way. (Do NOT allow the Soldier to fully tighten the windlass on the tourniquet on the other Soldier).

<b>Performance Measures</b>	GO	NO GO
1 Exposed the wound.	_____	_____
2 Placed C-A-T 2-3 inches above the wound on the injured extremity.	_____	_____
3 Pulled the free end of the self-adhering band through the buckle and routed through the friction adapter buckle, (unless arm wound).	_____	_____

<b>Performance Measures</b>	GO	NO GO
4 Pulled the self-adhering band tight around the extremity and fastened it back on itself as tightly as possible.	_____	_____
5 Twisted the windlass until the bleeding stopped.	_____	_____
6 Locked the windlass in place within the windlass clip.	_____	_____
7 Secured the windlass with the windlass strap.	_____	_____
8 Assessed for absence of a distal pulse.	_____	_____
9 Place a "T" and the time of application on the casualty's forehead with a marker.	_____	_____
10 Secured the C-A-T in place with tape.	_____	_____
11 Recorded treatment on the FMC.	_____	_____

**Evaluation Guidance:** Score each Soldier according to the performance measures in the evaluation guide. Unless otherwise stated in the task summary, the Soldier must pass all performance measures to be scored GO. If the Soldier fails any step, show what was done wrong and how to do it correctly.

**References**

**Required**  
DD Form 1380

**Related**  
None

## Bandage an Open Wound

**081-833-0068**

**CAUTION:** All body fluids should be considered potentially infectious. Always observe body substance isolation (BSI) precautions by wearing gloves and eye protection as a minimal standard of protection.

**Conditions:** You have a patient with an open wound that needs bandaged. You have treated all other immediate life threats and taken BSI (body substance isolation) precautions. You will need sterile roller bandages, sterile gauze pads, 4 inch gauze rolls, self-adhering bandages, tape, pen and SF 600 (Medical Record-Chronological Record of Medical Care). You are not in a CBRN environment.

**Standards:** Bandage an open wound without causing further injury to the patient.

### Performance Steps

1. Perform an EMT-B trauma assessment. (See task 081-833-0053.)
2. Select the bandaging material for the injury.
3. Explain the procedure to the patient.
4. Ask the patient about any allergies to adhesive tape.
5. Check distal pulses for circulation, sensory and motor (CSM) prior to application of bandage to an open wound.
6. Prepare the patient for bandaging by positioning the body part in a position of function, if able.
7. Place a waterproof pad (chux) underneath the patient.
8. Apply the dressing to the wound.
  - a. The dressing should be large enough to extend beyond the wound on all sides.

**NOTE:** If necessary, apply additional dressings to adequately cover the wound.

- b. Avoid touching the dressing in the area that will come in contact with the wound.

**NOTE:** If sterile dressings are not available; select the cleanest material available.

- c. Grasp the dressing by the corner, taking it directly from its protective pack and place it on the wound.

**WARNING:** Do not remove the first dressing if it becomes blood soaked. This dressing is helping with the formation of a clot.

- d. If dressing becomes blood soaked, add additional dressings on top.
9. Select the most appropriate size bandage to secure the dressing in place.
  - a. Tape may be appropriate for small wounds or wounds to the torso.
  - b. For wounds on the head or extremities, roller gauze or triangular bandages work best.

**NOTE:** Point pressure can occur if you bandage around a very small area. Avoid bandaging over a joint.

10. Apply the bandage.
  - a. For wounds of the hand, maintain position of function during bandaging by placing a roll of gauze in the patient's hand prior to applying the bandage.

*NOTE:* When bandaging the hands and feet, if possible, leave the fingers and toes exposed so CSM can be assessed.

- b. Start at the narrowest part of the limb and work your way up from there.
- c. To begin the bandage, make two or three wraps directly over one another to ensure a firm foundation for the bandage.
- d. Overlap each spiral approximately one-third (1/3) to one-half (1/2) to ensure adequate coverage of the dressing.
- e. Secure the self-adhering roller bandage with several overlying wraps.
- f. Overlap the bandage, keeping it snug.

*NOTE:* Be careful not to interfere with circulation.

- g. The bandage should extend beyond the dressing on all sides.

**CAUTION:** Make sure there are no loose ends of cloth, gauze or tape that could get caught when the patient is transported.

- h. Secure the bandage with tape or a square knot.
11. Check circulation after application of the bandage.
    - a. Check pulse distal to the wound.
    - b. Check CSM function to ensure that the bandage is not too tight.
    - c. Check for capillary refill (<2 seconds is normal), if applicable.
    - d. Inspect the skin below the bandaging for pale or cyanotic skin.
    - e. Ask the patient if they are experiencing any numbness, tingling sensation, coldness in the bandaged part or pain.

*NOTE:* These are indicators that the bandage may be too tight.

12. Check for irritation.
  - a. Ask the patient if the bandage rubs.
  - b. Check for bandage wrinkles near the skin surface.
  - c. Check for red skin or sores (ulcers) when the bandage is removed.
  - d. Remove and reapply only the bandage if necessary.

*NOTE:* If appropriate, immobilize the limb and watch to see that the bleeding remains controlled and check for edema during transport.

13. Keep the patient at rest.
14. Evacuate the patient if necessary.
15. Record the treatment given on the SF 600.

### **Evaluation Preparation:**

Setup: For training and evaluation, have another Soldier act as the patient.

Brief Soldier: Tell the Soldier the simulated patient requires a bandage to be placed over his open wound.



<b>Performance Measures</b>	<b>GO</b>	<b>NO GO</b>
1 Performed an EMT-B trauma assessment.	_____	_____
2 Selected the bandaging material for the injury.	_____	_____
3 Explained the procedure to the patient.	_____	_____
4 Asked the patient about any allergies to adhesive tape.	_____	_____
5 Checked distal pulses for CSM, prior to application of bandage to an open wound.	_____	_____
6 Prepared the patient for bandaging by positioning the body part in a position of function, if able.	_____	_____
7 Placed a waterproof pad (chux) underneath the patient.	_____	_____
8 Applied the dressing to the wound.	_____	_____
9 Selected the most appropriate sized bandage to secured the dressing in place.	_____	_____
10 Applied the bandage.	_____	_____
11 Checked circulation after application of the bandage.	_____	_____
12 Checked for irritation.	_____	_____
13 Kept the patient at rest.	_____	_____
14 Evacuated the patient if necessary.	_____	_____
15 Recorded the treatment given on the SF 600.	_____	_____

**Evaluation Guidance:** Score each Soldier according to the performance measures in the evaluation guide. Unless otherwise stated in the task summary, the Soldier must pass all performance measures to be scored GO. If the Soldier fails any step, show what was done wrong and how to do it correctly.

#### **References**

**Required**  
SF 600

**Related**  
None

## Initiate Treatment for Hypovolemic Shock

081-833-0047

**Conditions:** You have a casualty who is suffering from a significant blood loss. You will need an intravenous (IV) infusion set, IV fluids, (specifically Hextend), stethoscope, sphygmomanometer, a blanket or poncho, pen and a DD Form 1380 US Field Medical Card (FMC). You are in the field, you have taken body substance isolation precautions (BSI), and you are not in a CBRN environment.

**Standards:** Initiate treatment for hypovolemic shock, stabilize the casualty, minimize the effect of shock, and prepare for immediate evacuation without further injury to the casualty.

### Performance Steps

1. Control bleeding. (See task 081-833-0124.)
2. Maintain the airway.

*NOTE:* Administer oxygen, if available. (See task 081-833-0158.)

3. Reassure the casualty to reduce anxiety.

*NOTE:* Anxiety increases the heart rate, which worsens the casualty's condition. Anyone who has just been shot or who has experienced detonation of explosives nearby will have tachycardia.

4. Initiate one large bore (18 gauge) IV. (See task 081-833-0033.)

*NOTE:* To replace fluid loss accompanying injury with hemorrhage, Hextend is the fluid of choice.

5. Infuse Hextend.

- a. Give the casualty 500 ml of hextend.

(1) The usual amount is 500 ml; you can repeat the dose of 500 ml one time. A total of 1000 ml maximum amount of Hextend can be used for hypovolemia.

(2) A palpable radial pulse usually indicates that the casualty has a systolic blood pressure of 80 mm Hg.

- b. Repeat Hextend.

6. Maintain normal body temperature. Aggressively treat for hypothermia in a trauma patient.

7. Monitor the casualty.

*NOTE:* Give nothing by mouth. Moisten the casualty's lips with a wet cloth.

a. Check vital signs every 5 minutes until they return to normal, and then check every 15 minutes.

- b. Check the casualty's level of consciousness.

8. Record the procedure on the FMC.

9. Evacuate the casualty.

### Evaluation Preparation:

Setup: For training and evaluation, have another Soldier act as the casualty. For step 3, have the Soldier state what actions are taken when an IV infusion is initiated.

Brief Soldier: Tell the Soldier to initiate treatment for hypovolemic shock.

<b>Performance Measures</b>	<b>GO</b>	<b>NO GO</b>
1 Controlled bleeding.	_____	_____
2 Maintained the airway.	_____	_____
3 Reassured the casualty to reduce anxiety.	_____	_____
4 Initiated one large bore (18 gauge) IV.	_____	_____
5 Infused Hextend.	_____	_____
6 Maintained normal body temperature.	_____	_____
7 Monitored the casualty.	_____	_____
8 Recorded the procedure on the FMC.	_____	_____
9 Evacuated the casualty.	_____	_____

**Evaluation Guidance:** Score each Soldier according to the performance measures. Unless otherwise stated in the task summary, the Soldier must pass all performance measures to be scored GO. If the Soldier fails any steps, show what was done wrong and how to do it correctly.

#### **References**

**Required**  
DD Form 1380

**Related**  
None

## Initiate Treatment for an Open Chest Injury

081-833-0030

**Conditions:** You have a casualty with an open chest injury. You will need a DD Form 1380 US Field Medical Card (FMC). You have managed all other immediate life threats. You have performed a patient care hand wash, taken body substance isolation precautions and you are not in a CBRN environment.

**Standards:** Initiate treatment on an open chest wound without causing further injury to the casualty.

### Performance Steps

1. Perform a combat casualty assessment. (See task 081-833-0067.)
2. Check the casualty for signs and symptoms of chest injuries.
  - a. Deformities, contusions, abrasions, punctures/penetrations (DCAP), bleeding, tenderness, lacerations, swelling (BTLS).
  - b. Pleuritic pain that is increased by or occurs with respirations and is localized around the injury site.
  - c. Labored or difficult breathing.
  - d. Diminished or absent breath sounds.
  - e. Cyanotic lips, fingertips or fingernails.
  - f. Coughing up blood or bloody sputum.
  - g. Failure of one or both sides of the chest to expand normally upon inhalation.
  - h. Paradoxical breathing-the motion of the injured segment of a flail chest, opposite to the normal motion of the chest wall.
  - i. Enlarged neck veins.
  - j. Coughing up blood or bloody sputum.
  - k. Tracheal deviation-shift of the trachea from the midline toward the unaffected side due to pressure buildup on the injured side.
3. Check for an exit wound if a penetrating thoracic wound is initially found.
4. Determine the type of injury.
  - a. Open pneumothorax-air entering the pleural space through a defect in the pleural wall. Signs and symptoms:
    - (1) Respiratory distress.
    - (2) Anxiousness.
    - (3) Tachypnea.
  - b. Tension pneumothorax-air enters the chest cavity (pleural space) through a hole in the lung, expanding the space with every breath the casualty takes. The air becomes trapped and cannot escape. Signs and symptoms:
    - (1) Chest pain.
    - (2) Increased pressure in the chest causes lung(s) to collapse.
5. Initiate treatment for the open chest injury.
  - a. Open Pneumothorax.

- (1) Apply an occlusive dressing. (See task 081-833-0069.)

*NOTE:* In an emergency, any airtight material can be used. It must be large enough so it is not sucked up into the chest injury.

- (2) Check the casualty for an exit wound. If present, apply a second occlusive dressing.
- (3) Apply supplemental oxygen if available.

b. Tension pneumothorax.

(1) Apply an occlusive dressing. (See task 081-833-0069.) (2) Perform a needle chest decompression (NCD) if indicated. (See task 081-833-007.)

- (3) Administer oxygen.
- (4) Assist the casualty's respirations as necessary.
- (5) Monitor the casualty for progression of symptoms.

6. Record the care provided on the FMC.

7. Prepare the casualty for evacuation.

a. Position the casualty.

- (1) Conscious-in a comfortable position, preferably sitting.
- (2) Unconscious-on the injured side.

b. Evacuate the casualty-continue to assess the casualty until evacuated. The casualty should be evacuated by the most expedient means available.

**Evaluation Preparation:**

Setup: For training and evaluation, have another Soldier or mannequin act as the casualty. Use a moulage kit or similar materials to simulate entry and exit wounds.

Brief Soldier: Tell the Soldier to treat a casualty with an open chest wound. Tell the Soldier whether the injury is a simple pneumothorax or a tension pneumothorax. Place an exit wound on the simulated casualty.

<b>Performance Measures</b>	GO	NO GO
1 Performed a combat casualty assessment.	_____	_____
2 Checked the casualty for signs and symptoms of chest injuries.	_____	_____
3 Checked for an exit wound if a penetrating thoracic wound was initially found.	_____	_____
4 Determined the type of injury.	_____	_____
5 Initiated treatment for the open chest injury.	_____	_____
6 Recorded the care given on the FMC.	_____	_____
7 Prepared the casualty for evacuation.	_____	_____

**Evaluation Guidance:** Score each Soldier according to the performance measures. Unless otherwise stated in the task summary, the Soldier must pass all performance measures to be scored GO. If the Soldier fails any steps, show what was done wrong and how to do it correctly.

**References**

**Required**  
DD Form 1380

**Related**  
None

## Initiate Treatment for Chemical Burns of the Eye

081-833-0044

**Conditions:** You have a casualty with a chemical burn of the eye. All other more serious injuries have been assessed and treated. You have performed a patient care handwash. You will need irrigation equipment, irrigation solution (sterile water, sterile normal saline, or potable water), sterile dressings, gloves, field dressings, and a DD Form 1380 US Field Medical Card (FMC). You are not in a CBRN environment.

**Standards:** Initiate treatment for chemical burns of the eye without causing further injury to the casualty.

### Performance Steps

1. Reassure the casualty.
2. Identify the substance the casualty was exposed to.

**NOTE:** Do not delay treatment to perform this step.

a. Alkali-the most dangerous of all substances due to penetrating factor (common substances contain the hydroxides of ammonia, lye, potassium, magnesium, and lime).

- (1) Fertilizers.
- (2) Cleaning products, drain cleaners, and oven cleaners.
- (3) Plaster and cement.

b. Acid-usually less severe than alkali burns (common acids contain sulfuric acid, hydrochloric acid, nitric acid, acetic acid, chromic acid and hydrofluoric acid).

- (1) Glass polish, vinegar, and nail polish remover.
- (2) Automobile battery acid.

c. Irritants-substances that have a neutral pH, tend to cause more discomfort to the eye than actual damage.

- (1) Most household detergents.
- (2) Pepper spray.

3. Check for signs and symptoms.

- a. Irritation.
- b. Pain and redness.
- c. Watering or tearing.
- d. Possible erosion of the corneal surface.
- e. Inability to keep the eye open.
- f. Swelling of eyelid.
- g. Blurred vision.

4. Initiate treatment for the chemical burn.

- a. IMMEDIATELY flood the eyes with water.

b. Keep irrigating the eye with running water from a faucet, low pressure hose, bottle, cup, IV setup. Hold the irrigating tip 1 to 1 ½ inch away from the casualty’s eye(s), direct the irrigating solution gently from the inner canthus to the outer canthus.

c. Start the transport and continue washing out the eye(s) for at least 20 minutes or until the casualty’s arrival at the treatment facility.

d. Dry the area around the eye(s) by gently patting with gauze sponges. Do not touch the casualty’s eye.

e. Cover the injured eye(s) with a clean, sterile dressing.

*NOTE:* In a combat environment, the eyes may have to remain uncovered so the casualty can see to get away from danger.

Burned eyelids swell to protect the underlying eyes. If the casualty can be evacuated immediately, the eyes may be loosely covered with sterile dressings moistened with sterile saline.

5. Record the treatment given on the FMC.

6. Evacuate the casualty.

**Evaluation Preparation:**

Setup: For training and evaluation, use another Soldier to be the simulated casualty.

Brief Soldier: Tell the Soldier to initiate treatment for a chemical burn of the eyes on the simulated casualty.

<b>Performance Measures</b>	GO	NO GO
1 Reassured the casualty.	_____	_____
2 Identified the substance the casualty was exposed to.	_____	_____
3 Checked for signs and symptoms.	_____	_____
4 Initiated treatment for the chemical burn.	_____	_____
5 Recorded the treatment given on the FMC.	_____	_____
6 Evacuated the casualty.	_____	_____

**Evaluation Guidance:** Score each Soldier according to the performance measures. Unless otherwise stated in the task summary, the Soldier must pass all performance measures to be scored GO. If the Soldier fails any steps, show what was done wrong and how to do it correctly.

**References**

**Required**  
DD Form 1380

**Related**  
None

## Initiate Treatment for a Soft Tissue Injury

081-833-0063

**Conditions:** You have a casualty with a soft tissue injury. You have treated all life threats. You have performed a patient care hand wash and taken body substance isolation (BSI) precautions. You will need the casualty's medical record, normal saline, sterile water, gauze, non-sterile gloves, marker, a needle, No. 11 blade or tissue forceps, dressing materials, wrap, antibiotic ointment, tape, pen and SF 600 (Medical Record-Chronological Record of Medical Care). You are not in a CBRN environment.

**Standards:** Initiate treatment for a soft tissue injury without causing further injury.

### Performance Steps

1. Solicit the casualty's history.
2. Assess injury for underlying complications.
  - a. Abrasions.
    - (1) Depth of wound (relates to method of anesthesia and cleaning).
    - (2) Amount of body surface (fluid loss can be significant in children).
    - (3) Amount of contamination (precursor to infection).
  - b. Contusions.
    - (1) Underlying fracture. Forceful impact of objects creating injury can result in fractures.
    - (2) Vascular involvement (extensive bleeding into tissue).
    - (3) Check distal circulation.
    - (4) Measure or mark the outline of the contusion.
    - (5) Measure circumference of injured extremity, and compare measurement to uninjured extremity.
    - (6) Neurological involvement. Test the sensation and movement of the injured part. Any signs of neurologic deficit may indicate a serious complication.
3. Initiate treatment for an abrasion.
  - a. Principles of management are as follows:
    - (1) Prevention of infection.
    - (2) Promotion of rapid healing.
    - (3) Prevention of "tattooing" from retained foreign bodies.
  - b. Wound must be gently but thoroughly scrubbed with normal saline.
  - c. Remove all foreign matter that cannot be scrubbed out by using a needle, No. 11 blade, or tissue forceps.
  - d. Apply antibiotic ointment.
  - e. Administer antibiotic therapy, if needed. Antibiotic therapy may be indicated for prophylaxis (consult medical officer).
  - f. Give casualty instructions on wound care and signs and symptoms of infection.
    - (1) Topical antibiotic ointment applied three or four times a day.



- (2) Dressing changed every 2 to 3 days with gentle cleaning.
- (3) Monitor abrasion for signs and symptoms of infection.
- 4. Initiate treatment for a contusion.
  - a. Ensure that there is no underlying fracture or evidence of any neurological or vascular involvement.
  - b. Pad and splint injury, if needed.
  - c. Manage complications appropriately (consult medical officer if question of underlying injury).
    - (1) Apply splint or cast to fractures (following medical officer's recommendation).
    - (2) Refer vascular or neurologic injury to a medical officer.
  - d. Prescribe rest, ice, compression, and elevation (RICE).
    - (1) Wrap injured area with a roller bandage to compress the wound and slow bleeding into the tissue.
    - (2) Apply ice to area over the wound.
    - (3) If wound is significant, have casualty keep area elevated.
- 5. Record all treatment in the casualty's medical record on SF 600.

**Evaluation Preparation:**

This task is best evaluated by performance of the steps. Give the Soldier a simulated casualty and a scenario in which they must manage contusions or abrasions.

<b>Performance Measures</b>	GO	NO GO
1 Solicited the casualty's history.	_____	_____
2 Assessed the injury for underlying complications.	_____	_____
3 Initiated treatment for an abrasion.	_____	_____
4 Initiated treatment for a contusion.	_____	_____
5 Recorded all treatment in the casualty's medical record on SF 600.	_____	_____

**Evaluation Guidance:** Score each Soldier according to the performance measures. Unless otherwise stated in the task summary, the Soldier must pass all performance measures to be scored GO. If the Soldier fails any steps, show what was done wrong and how to do it correctly.

**References**

**Required**  
SF 600

**Related**  
None

## Perform a Needle Chest Decompression

**081-833-0075**

**Conditions:** You have a casualty with penetrating chest trauma with an occlusive dressing in place. You will need a 14 gauge, 3 1/4 inch needle catheter, povidone-iodine swab, alcohol swabs, tape 2 inches or greater, pen and a DD Form 1380 US Field Medical Card (FMC). You have taken body substance isolation precautions and you are not in a CBRN environment.

**Standards:** Perform a needle chest decompression without causing unnecessary injury to the casualty.

*NOTE:* Pneumothorax is defined as the presence of air within the pleural space. Air may enter the pleural cavity either from the lungs through a rupture, laceration, or from the outside through a sucking chest wound. Trapped air in the pleural space compresses the lung beneath it. Unrelieved pressure will push the contents of the mediastinum in the opposite direction, away from the side of the tension pneumothorax. This, in turn, will compromise venous return to the heart and interfere with respiration.

### Performance Steps

1. Verify the presence of a tension pneumothorax.

*NOTE:* Any casualty with penetrating torso trauma with increased respiratory distress, will be treated as if he has a tension pneumothorax.

2. Locate the insertion site. Locate the second intercostal space (between the second and third ribs) at the midclavicular line (approximately in line with the nipple) on the affected side of the patient's chest.

3. Thoroughly cleanse a 3 to 4 inch area around the insertion site. Begin in the center and work outward using a circular motion.

4. Insert a 3 1/4 inch, 14 gauge needle over the top of the rib at a 90 degree angle to the chest wall, to the hub.

5. Remove the needle, leaving the catheter in place.

6. Stabilize the catheter hub to the chest with tape.

7. Place the casualty in a sitting position or in the recovery position with injured side down.

8. Record the treatment on the FMC.

9. Continue monitoring casualty by reassessment of reoccurrence of respiratory distress.

### Evaluation Preparation:

Setup: For training and evaluation, use a mannequin or have another Soldier act as the casualty. Under no circumstances will the needle be inserted. Have the Soldier demonstrate and explain what he would do.

### Performance Measures

	GO	NO GO
1 Verified the presence of tension pneumothorax.	_____	_____
2 Located the insertion site.	_____	_____
3 Cleansed a 3-4 inch area around the insertion site.	_____	_____
4 Inserted a 3 1/4 inch, 14 gauge needle over the top of the rib at a 90 degree angle to the chest wall, to the hub.	_____	_____

**Performance Measures**

	GO	NO GO
5 Removed the needle, leaving the catheter in place.	_____	_____
6 Stabilized the catheter hub to the chest with tape.	_____	_____
7 Placed the casualty in a sitting position or in the recovery position, injured side down.	_____	_____
8 Recorded the treatment on the FMC.	_____	_____
9 Continued monitoring casualty by reassessment of reoccurrence of respiratory distress.	_____	_____

**Evaluation Guidance:** Score each Soldier according to the performance measures in the evaluation guide. Unless otherwise stated in the task summary, the Soldier must pass all performance measures to be scored GO. If the Soldier fails any step, show what was done wrong and how to do it correctly.

**References**

**Required**  
DD Form 1380

**Related**  
None

## Initiate Treatment for a Closed Chest Injury

081-833-0078

**Conditions:** You have a casualty with a closed chest injury. You will need scissors, adhesive tape, field dressings, padding, ace wrap, cravats, and a DD Form 1380 US Field Medical Card (FMC). You have managed all other immediate life threats. You have performed a patient care hand wash, taken body substance isolation precautions and you are not in a CBRN environment.

**Standards:** Initiate treatment on a closed chest wound without causing further injury to the casualty.

### Performance Steps

1. Perform a combat casualty assessment. (See task 081-833-0067.)
2. Check the casualty for signs and symptoms of chest injuries.
  - a. Deformities, contusions, abrasions, punctures/penetrations (DCAP), bleeding, tenderness, lacerations, swelling (BTLS).
  - b. Pleuritic pain that is increased by or occurs with respirations and is localized around the injury site.
  - c. Labored or difficult breathing.
  - d. Diminished or absent breath sounds.
  - e. Cyanotic lips, fingertips or fingernails.
  - f. Rapid, weak pulse and low blood pressure.
  - g. Coughing up blood or bloody sputum.
  - h. Failure of one or both sides of the chest to expand normally upon inhalation.
  - i. Paradoxical breathing-the motion of the injured segment of a flail chest, opposite to the normal motion of the chest wall.
  - j. Enlarged neck veins.
  - k. Coughing up blood or bloody sputum.
  - l. Tracheal deviation-shift of the trachea from the midline toward the unaffected side due to pressure buildup on the injured side.
3. Check for an exit wound.
4. Determine the type of injury.
  - a. Rib fracture-generally caused by a direct blow to the chest or compression of the chest. Severe coughing can also cause a rib fracture.
    - (1) Signs and Symptoms:
      - (a) Pain, often excruciating movement and breathing.
      - (b) Inability to breathe deeply and coughing.
      - (c) Creptitation (grating sensation).
      - (d) Deformity.
      - (e) Tachypnea (rapid breathing) that may be shallow.

- (f) Tenderness upon palpation.
  - (g) Casualty may present in a guarded position, holding their arm over the injured site.
  - (2) Complications:
    - (a) Internal bleeding (hemothorax).
    - (b) Shock.
  - b. Flail chest-two or more ribs fractured in two or more places or a fractured sternum.
    - (1) Signs and Symptoms:
      - (a) Severe pain at the site.
      - (b) Tachypnea.
      - (c) Paradoxical Respirations.
    - (2) Complications:
      - (a) Respiratory insufficiency.
      - (b) Pneumothorax with hemothorax.
      - (c) Pulmonary contusion.
  - c. Hemothorax-bleeding from lacerated blood vessels in the chest cavity and/or lungs. It results in the accumulation of blood in the chest cavity not outside the lungs.
    - (1) Signs and symptoms:
      - (a) Hypotension due to blood loss.
      - (b) Shock.
      - (c) Cyanosis.
      - (d) Tightness in the chest.
      - (e) Mediastinal shift may produce deviated trachea away from the affected side.
      - (f) Hemoptysis-pink or red frothy sputum when the casualty coughs.
    - (2) Complications:
      - (a) Possibility of hypovolemic shock.
      - (b) Frequently accompanies a pneumothorax.
5. Initiate treatment for the closed chest injury.
- a. Rib fracture.
    - (1) Use a sling and swathe to immobilize the affected side.

**NOTE:** Do not completely wrap the chest or apply the swathe snugly. This could impede normal ventilation.

**WARNING:** Do not tape, strap, or bind the chest, these interventions increase the development of pneumonia.

- (2) Administer oxygen if available.
- (3) Reassure and continuously reassess the casualty.

**NOTE:** The broken rib may puncture the lung or the skin.

b. Flail chest.

- (1) Establish and maintain an airway.
- (2) Administer oxygen if available.
- (3) Assist the casualty's respirations as necessary.
- (4) Stabilization-splinting the flail segment.
- (5) Monitor the casualty for signs of hemothorax or tension pneumothorax, as necessary.

c. Hemothorax.

- (1) Establish and maintain an airway.
- (2) Administer oxygen.
- (3) Assist the casualty's breathing, as necessary.

6. Treat for shock if necessary. (See task 081-833-0047.)

7. Record the care provided on the FMC.

8. Evacuate the casualty.

**Evaluation Preparation:**

Setup: For training and evaluation, have another Soldier or mannequin act as the casualty.

Brief Soldier: Tell the Soldier to initiate treatment for a casualty with a closed chest injury. Tell the Soldier whether the injury involves a simple rib fracture, flail chest, or a hemothorax.

**Performance Measures**

	GO	NO GO
1 Performed a combat casualty assessment.	_____	_____
2 Checked the casualty for signs and symptoms of chest injuries.	_____	_____
3 Checked for an exit wound.	_____	_____
4 Determined the type of injury.	_____	_____
5 Initiated treatment for the closed chest injury.	_____	_____
6 Treated for shock if necessary.	_____	_____
7 Recorded the care given on the FMC.	_____	_____
8 Evacuated the casualty.	_____	_____

**Evaluation Guidance:** Score each Soldier according to the performance measures. Unless otherwise stated in the task summary, the Soldier must pass all performance measures to be scored GO. If the Soldier fails any steps, show what was done wrong and how to do it correctly.

**References**

**Required**  
DD Form 1380

**Related**  
None

## Initiate Treatment for an Amputation

**081-833-0061**

**Conditions:** A casualty has experienced a partial or complete amputation. All other more serious injuries have been assessed and treated. You will need a tourniquet, marker, sterile gauze, intravenous (IV) equipment, saline, plastic bag, container, DD Form 1380 US Field Medical Card (FMC), ice, and cravats. You are not in a CBRN environment.

**Standards:** Initiate treatment based on severity and location of amputation without causing further injury to the casualty.

*NOTE* If an obvious amputation with significant hemorrhage, immediately apply a tourniquet. (See tasks 081-088-0065 and 081-833-0066.)

### Performance Steps

1. Assess the casualty. (See tasks 081-833-0053, 081-833-0067 and 081-833-0156.)
2. Initiate treatment for traumatic amputations.
  - a. Combat environment (under fire).
    - (1) Move the casualty to a covered and concealed location if not receiving any direct fire.
    - (2) Immediately apply a tourniquet.
  - b. Noncombat environment (not under fire).
    - (1) Assess airway, hemorrhage, breathing, and circulation.
    - (2) Apply a tourniquet to control bleeding.
3. Using a marker, make a "T" on the casualty's forehead.
4. Treat for shock. (See task 081-833-0047.)
5. Care for the amputated part.
  - a. Wrap the part loosely in saline-moistened sterile gauze.
  - b. Seal the amputated part inside a plastic bag or wrap it in a cravat. The amputated part should then be placed in another container containing ice. Keep it cool, but do not allow it to freeze.
  - c. Avoid further injury to the amputated part.
    - (1) Never warm an amputated part.
    - (2) Never place an amputated part directly in water.
    - (3) Never place an amputated part directly on ice.
    - (4) Never use dry ice to cool an amputated part.
  - d. Transport the part with the casualty to the hospital for possible reimplantation or skin graft.

*NOTE:* Do not delay transport of a patient in order to locate and care for an amputated part.

6. Record all treatment on the casualty's FMC.
7. Evacuate the casualty to a definitive care facility as soon as possible.

**Evaluation Preparation:**

Setup: For training and evaluation, use a simulation device capable of having an amputation with a separate extremity stump.

Brief Soldier: Tell the Soldier the simulated patient has an amputation that requires treatment.

<b>Performance Measures</b>	GO	NO GO
1 Assessed the casualty.	_____	_____
2 Initiated treatment for traumatic amputations.	_____	_____
3 Marked the casualty's forehead with a "T" with a marker.	_____	_____
4 Treated for shock.	_____	_____
5 Cared for the amputated part.	_____	_____
6 Recorded all treatment on the casualty's FMC.	_____	_____
7 Evacuated the casualty to a definitive care facility as soon as possible.	_____	_____

**Evaluation Guidance:** Score each Soldier according to the performance measures in the evaluation guide. Unless otherwise stated in the task summary, the Soldier must pass all performance measures to be scored GO. If the Soldier fails any step, show what was done wrong and how to do it correctly.

**References**

**Required**  
DD Form 1380

**Related**  
None



## Apply an Occlusive Dressing

**081-833-0069**

**Conditions:** You have a casualty with penetrating chest trauma. You will need a stethoscope, scissors, tape 2 inches or greater in width, exam gloves, occlusive material or commercial chest seal, pen, and DD Form 1380 US Field Medical Card (FMC). You are not in a CBRN environment.

**Standards:** Complete all steps necessary to apply an occlusive dressing to a penetrating chest injury, without causing further injury to casualty.

### Performance Steps

1. Take body substance isolation.
2. Perform a combat casualty assessment. (See task 081-833-0213.)
3. Expose the injury.

**NOTE:** Remove enough clothing to obtain access to the injury.

4. Apply an occlusive dressing.
  - a. Upon full expiration, cover the wound with large, occlusive material dressing, covering the first wound encountered.
  - b. Commercial chest seal - ensure the material extends 2 inches beyond the edge of the wound.
  - c. Improvised occlusive dressing - ensure material used extends 2 inches beyond the edge of the wound.
  - d. Tape all four sides of the dressing.
5. Log roll the casualty or have them sit up and examine the back for an exit wound.
6. Cover the exit wound on expiration, if present, with a large occlusive dressing.
7. Record the treatment on the FMC.
8. Continue monitoring the casualty for signs of respiratory distress.

### Evaluation Preparation:

**Setup:** For training and evaluation, use a simulated casualty that is moulaged to reflect penetrating torso trauma.

**Brief Soldier:** Tell the Soldier the simulated casualty requires an occlusive dressing to be applied.

<b>Performance Measures</b>	GO	NO GO
1 Took body substance isolation.	_____	_____
2 Performed a combat casualty assessment. (See task 081-833-0067.)	_____	_____
3 Exposed the injury.	_____	_____
4 Applied an occlusive dressing.	_____	_____
5 Log rolled the casualty or had the conscious casualty sit up and examined the back for an exit wound.	_____	_____
6 Covered the exit wound, if applicable.	_____	_____

**Performance Measures**

GO            NO GO

7 Recorded the treatment on the FMC.

\_\_\_\_\_

8 Continued monitoring the casualty for signs of respiratory distress.

\_\_\_\_\_

**Evaluation Guidance:** Score each Soldier according to the performance measures in the evaluation guide. Unless otherwise stated in the task summary, the Soldier must pass all performance measures to be scored GO. If the Soldier fails any step, show what was done wrong and how to do it correctly.

**References**

**Required**  
DD Form 1380

**Related**  
None

## Perform Extrication Using a Seated Device

081-833-0096

**WARNING:** All body fluids should be considered potentially infectious. Always observe BSI precautions by wearing gloves and eye protection as a minimal standard of protection.

**Conditions:** You will need to extricate a casualty with a suspected spinal injury using a seated device. All other life threatening injuries have been treated. Another Soldier is available to assist you. You both have performed a patient care hand wash, and taken body substance isolation (BSI) precautions. You will need a Kendrick extrication device (KED), a rigid cervical collar, straps, padding, cravats, a long spine board, pen, and DD Form 1380 US Field Medical Card (FMC). You are not in a CBRN environment.

**Standards:** Perform extrication using a seated device such as a KED for a casualty with a suspected spinal injury without causing further injury/harm.

### Performance Steps

1. Check for signs and symptoms of a spinal injury.

*NOTE:* With unresponsive casualties, you should attempt to identify the mechanism of injury (MOI).

**WARNING:** If you suspect the casualty has a spinal injury, you must treat them as though they have a spinal injury; when in doubt, immobilize.

- a. First you will want to minimize all movement of the spine.
  - b. Instruct the responsive casualty to remain as still as possible.
  - c. Instruct the responsive casualty to answer your questions with a verbal response only and not to shake or nod their head.
2. Instruct the second Soldier to establish and maintain manual inline stabilization of the casualty's spine.
    - a. Have your assistant properly position their hands.
    - b. Keeping the casualty's head in a neutral position and the nose in line with the casualty's navel.
    - c. Careful movement of the head and neck into a neutral position must be stopped if movement results in any of the following:
      - (1) Neck muscle spasm.
      - (2) Increased pain.
      - (3) Increase in numbness, tingling, or loss of motor ability.
      - (4) Compromise of the airway or ventilation.
    - d. Instruct your assistant to continue manual stabilization until the casualty is secured to a long spine board.
- NOTE:* Manual stabilization is a method of stabilization where the assistant firmly grasps the casualty's head with both hands and attempts to keep it from moving.
- e. Be gentle when handling the extremities.
  - f. If possible, inspect the spine for deformities, contusions, abrasions, punctures or penetrations, burns, tenderness, lacerations, and swelling (DCAP-BTLS).

*NOTE:* Do not move the casualty in an attempt to elicit a painful response.

g. You can ask the responsive casualty where the pain is and/or palpate the spine with a gloved hand.

h. Palpate for tenderness, instability, or crepitus (TIC) in the spinal region.

*NOTE:* In addition to the normal components of your focused history and physical exam, try to pinpoint any pain or tenderness along the spine as best as you can.

3. Apply a rigid cervical collar. (See task 081-833-0177.)

4. Check circulation, sensation, and motor (CSM) function of all extremities.

*NOTE:* Advise the casualty of what you are planning to do before moving the limb.

a. Assess the radial pulse rate, quality, and rhythm. Check both radial pulses at the same time in order to compare one against the other.

b. Assess pain response, light touch response, and grip response in both hands.

(1) Ask casualty if they can tell you which finger you are touching or gently applying slight pressure to a finger.

*NOTE:* Casualty is not allowed to look or move head, head must be maintained in neutral in line stabilization.

(2) Place two or three of your gloved fingers into both of casualty's hands and have them squeeze as hard as they can to check grip response.

c. Assess pedal pulse on each foot at the same time in order to compare one against the other for quality and strength.

**WARNING:** In some casualties it may be difficult to find pedal pulses in their feet. In cases like this, it is a good idea to also check capillary refill as a back-up to the pedal pulses.

d. Assess plantar flexion and dorsiflexion of each foot.

e. Ask casualty if they can tell you which toe you are touching.

*NOTE:* Must remove casualty's shoes in order to perform assessment of their feet.

5. Position the immobilization/KED behind the casualty and center it.

*NOTE:* Before placing the KED behind the casualty, the two long straps leg straps/groin straps are unfastened and placed behind the device.

a. Properly align the device.

b. Wrap the vest around the casualty's torso.

c. Ensure that the device is tucked well up into the armpits. Adjust as necessary.

d. Secure the chest/torso straps. Evaluate and adjust the straps as needed.

*NOTE:* Chest/torso straps should not inhibit chest rise, resulting in respiratory compromise.

*NOTE:* Chest/torso straps must be tight enough so the device does not move up, down, left, or right excessively, but not so tight as to restrict the casualty's breathing.

e. Secure the leg/groin straps.

f. Secure the head to the device.

(1) Apply appropriate padding behind the head to maintain proper alignment.

(2) Apply velcro head straps.

*NOTE:* Head immobilization straps should not allow excessive movement.

- g. Secure the casualty's wrist together and legs together using cravats.
- 6. Pivot the casualty onto the backboard/long spine board, while maintaining manual in-line neutral stabilization.
  - a. Release groin straps once casualty is on backboard/long spine board.
  - b. Secure casualty to backboard/long spine board. (See task 081-833-0181.)
- 7. Reassess CSM function of all extremities.
- 8. Record procedure and casualty's tolerance of procedure on FMC.

**Evaluation Preparation:**

Setup: For training and evaluation, have another Soldier to act as the casualty. The Soldier being tested is to act as the team leader and direct the actions of the assistant. The casualty may be placed in a vehicle or other confined space. Tell the casualty not to assist the Soldier in any way. Tell the assistant to only perform those actions the Soldier being evaluated directs.

Brief Soldier: To test step 1, tell the Soldier to state the signs and symptoms of a spinal injury. Tell the Soldier that the casualty has a suspected spinal injury. Then tell the Soldier to apply the KED and position the casualty on a long spine board for transport.

<b>Performance Measures</b>	GO	NO GO
1 Checked for signs and symptoms of a spinal injury.	_____	_____
2 Instructed the second Soldier to establish and maintain manual inline stabilization of the casualty's spine.	_____	_____
3 Applied a rigid cervical collar. (See task 081-833-0177.)	_____	_____
4 Checked circulation, sensation, and motor (CSM) function of all extremities.	_____	_____
5 Positioned the immobilization/KED behind the casualty and centered it.	_____	_____
6 Pivoted the casualty onto the backboard/long spine board, while maintaining manual in-line neutral stabilization.	_____	_____
7 Reassessed CSM function of all extremities.	_____	_____
8 Recorded procedure and casualty's tolerance of procedure on FMC.	_____	_____

**Evaluation Guidance:** Score each Soldier according to the performance measures. Unless otherwise stated in the task summary, the Soldier must pass all performance measures to be scored GO. If the Soldier fails any steps, show what was done wrong and how to do it correctly.

**References**

**Required**  
DD Form 1380

**Related**  
None

## Initiate Treatment for Inguinal Wounds

**081-833-0081**

**Conditions:** You have a casualty who is bleeding externally from an inguinal wound. Casualty has a belt and all belt loops are intact. You will need gloves, cravat, combat gauze, kerlix, 3 inch tape, and an assistant to hold pressure. You are not in a CBRN environment.

**Standards:** Initiate treatment for an inguinal wound and control bleeding without causing further injury to the casualty.

### Performance Steps

1. Take body substance isolations.
  2. Expose the wound.
    - a. Remove all clothing around wound to fully expose wound.
    - b. Check for exit wound.
    - c. Tighten belt on casualty.
  3. Pack the wound with combat gauze.
    - a. Using the four "P's" of packing (peel, push, pile, and pressure) pack the gauze directly into the wound.
    - b. Hold pressure for a minimum of 3 minutes.
    - c. Pack with kerlix if required.
  4. Place tail of cravat under posterior belt on injured side and fan open cravat.
  5. Wrap cravat from posterior to anterior completely covering packing along the contour of groin.
  6. Tie NON-slip knot to other tail of cravat.
- NOTE:* When you tie the knot, make sure to pull as tight as possible to maintain pressure.
7. Secure tails and knot with 3 inch tape 1-1/2 times around the whole cravat.
  8. Swathe legs together to provide additional pressure to wound.
  9. Continue to assess wound for further bleeding.

### Evaluation Preparation:

Setup: For training and evaluation, use another Soldier to simulate a casualty with an inguinal wound.

Brief Soldier: Tell the Soldier the simulated requires treatment for an inguinal wound.

<b>Performance Measures</b>	GO	NO GO
1 Took body substance isolation.	_____	_____
2 Exposed the wound, checked for exit wound and tightened belt.	_____	_____
3 Packed the wound with combat gauze and held pressure for 3 minutes.	_____	_____
4 Slide tail under belt on posterior belt on injured side and fan open cravat.	_____	_____
5 Wrapped cravat from back to front along contour of groin.	_____	_____

**Performance Measures**

	GO	NO GO
6 Tied a non-slip knot to other tail as tight as possible.	_____	_____
7 Secured with 3 inch tape around entire cravat.	_____	_____
8 Swathed legs together to provide additional pressure on wound.	_____	_____
9 Continued to assess for further bleeding.	_____	_____

**Evaluation Guidance:** Score each Soldier according to the performance measures. Unless otherwise stated in the task summary, the Soldier must pass all performance measures to be scored GO. If the Soldier fails any steps, show what was done wrong and how to do it correctly.

**References**

**Required**  
None

**Related**  
None

## Initiate Treatment for Neck Wounds

**081-833-0091**

**Conditions:** You have a casualty who is bleeding from a penetrating neck wound that requires packing and a pressure dressing. You will need gloves, 6 inch elastic bandage, 2 cravats, kerlix, combat gauze, 3 inch tape, and an assistant to hold pressure. You are not in CBRN environment.

**Standards:** Initiate treatment for a neck wound and control bleeding without causing further injury to the casualty.

### Performance Steps

1. Take body substance isolations.
2. Expose the wound, if necessary.
3. Pack the wound with combat gauze.
  - a. Using the four “P’s” of packing (peel, push, pile, and pressure) pack the gauze directly into the wound.
  - b. Hold pressure for a minimum of 3 minutes.
  - c. Pack with kerlix if required.
4. Place elastic bandage over dressing leaving a tail.
5. Wrap elastic bandage under opposite arm.
6. Continue to wrap around neck and under arm pulling elastic bandage tight for pressure, covering entire dressing.
7. Secure dressing by tying a non-slip knot with end of elastic bandage and tail.
8. Secure elastic bandage tails and knot with 2 or 3 inch tape wrapping a minimum of 1-1/2 times around tail and knot.
9. Swathe arm to torso.
10. Continue to assess wound for further bleeding.

### Evaluation Preparation:

Setup: For training and evaluation, use another Soldier to simulate a casualty with a neck wound.

Brief Soldier: Tell the Soldier the simulated requires treatment for a neck wound.

<b>Performance Measures</b>	GO	NO GO
1 Took body substance isolation.	_____	_____
2 Exposed the wound, if necessary.	_____	_____
3 Packed the wound with combat gauze and held pressure for 3 minutes.	_____	_____
4 Placed elastic bandage over dressing, leaving a tail.	_____	_____
5 Wrapped elastic bandage under opposite arm.	_____	_____
6 Continued to wrap elastic bandage around neck and under opposite arm pulling elastic bandage tight, covering entire dressing.	_____	_____



<b>Performance Measures</b>		GO	NO GO
7	Secured dressing by tying a non-slip knot with end of elastic bandage and tail.	_____	_____
8	Secured elastic bandage tails and knot with 2 or 3 inch tape wrapping a minimum of 1-1/2 times around tail and knot.	_____	_____
9	Swathed arm to torso.	_____	_____
10	Continued to assess wound for further bleeding.	_____	_____

**Evaluation Guidance:** Score each Soldier according to the performance measures. Unless otherwise stated in the task summary, the Soldier must pass all performance measures to be scored GO. If the Soldier fails any steps, show what was done wrong and how to do it correctly.

### References

**Required**  
None

**Related**  
None

## Control Bleeding

081-833-0124

**CAUTION:** All body fluids should be considered potentially infectious. Always observe body substance isolation (BSI) precautions by wearing gloves and eye protection as a minimal standard of protection. In severe cases, you should wear gloves, eye protection, gown and shoe covers to protect yourself of splashes, projectile fluids, spurting fluids or splashes onto your clothing and foot wear.

**Conditions:** You have a casualty who is bleeding externally. You will need field dressings, emergency bandages, gauze pads, gauze roller bandage, sterile dressing, kerlix, ace wraps, hemostatic bandage, combat application tourniquet (C-A-T), pen, and a DD Form 1380 US Field Medical Card (FMC). You have taken body substance isolation precautions and you are not in a CBRN environment.

**Standards:** Control bleeding without further harming the casualty.

*NOTE:* If in a tactical environment, perform a combat casualty assessment. (See task 081-833-0067.)

### Performance Steps

1. Determine if the bleeding is life threatening. If bleeding is life threatening, immediately apply a C-A-T. (See task 081-833-0065.)

*NOTE:* The three methods of controlling external bleeding are direct pressure, hemostatic agents and tourniquet.

2. Apply direct pressure.

a. Expose the wound.

b. Place a sterile gauze or dressing over the injury site and apply fingertips, palm or entire surface of one hand and apply direct pressure for 3-5 minutes until bleeding is stopped.

*NOTE:* If bleeding is profuse, apply direct pressure to the wound with your gloved hand initially while procuring a sterile dressing with your other hand. Larger wounds require a larger surface area of pressure and usually more pressure as well. Pack large, gaping wounds with sterile gauze and apply direct pressure.

**CAUTION:** Once bleeding has been controlled, it is important to check a distal pulse to make sure that the dressing has not been applied too tightly. If a pulse is not palpable, adjust the dressing to re-establish circulation.

3. Apply a pressure dressing or emergency bandage if the wound continues to bleed. (See task 081-833-0212.)

*NOTE:* If bleeding continues, go to step 4.

**CAUTION:** In combat, while under enemy fire, a tourniquet is the primary means to control bleeding. It allows the individual, his battle buddy, or the combat medic to quickly control life threatening hemorrhage until the casualty can be moved away from the firefight. Always treat life threatening hemorrhage while you and the casualty are behind cover.

4. Apply a tourniquet if the wound continues to bleed. (See tasks 081-833-0065 and 081-833-0066.)

**NOTE:** If the source of the bleeding was due to a traumatic amputation, initiate treatment for an amputation. (See task 081-833-0061.)

5. Consider conjunctive therapies to control bleeding as necessary.
  - a. Splinting. (See tasks 081-833-0263 and 081-833-0141.)
  - b. Hemostatic bandage. (See task 081-833-0211.)
6. Initiate treatment for shock as needed. (See task 081-833-0047.)
7. Record treatment given on the FMC.
8. Evacuate the casualty.

**Evaluation Preparation:**

Setup: For training and evaluation, have another Soldier act as the casualty and place a large laceration on an extremity that does not stop bleeding with a pressure dressing.

Brief Soldier: Tell the Soldier to treat the casualty.

<b>Performance Measures</b>	GO	NO GO
1 Determined if the bleeding was life threatening. If life threatening, went to step 4 immediately.	_____	_____
2 Applied direct pressure with sterile guaze for 3-5 minutes.	_____	_____
3 Applied a pressure dressing or emergency bandage if the wound continued to bleed.	_____	_____
4 Applied a tourniquet if the wound continued to bleed.	_____	_____
5 Considered conjunctive therapies to control bleeding if necessary.	_____	_____
6 Initiated treatment for shock as needed.	_____	_____
7 Recorded treatment given on a FMC.	_____	_____
8 Evacuated the casualty.	_____	_____

**Evaluation Guidance:** Score the Soldier GO if all steps are passed. Score the Soldier NO-GO if any step is failed. If the Soldier fails any step, show what was done wrong and how to do it correctly.

**References**

**Required**  
DD Form 1380

**Related**  
None

## Initiate Treatment for Axillary Wounds

**081-833-0079**

**Conditions:** You have a casualty who is bleeding externally from an axillary wound. You will need gloves, 6 inch elastic bandage, combat gauze, kerlix, 2 or 3 inch tape, and an assistant to hold pressure. You are not in a CBRN environment.

**Standards:** Initiate treatment for axillary wounds and control bleeding without causing further injury to the casualty.

### Performance Steps

1. Take body substance isolations.
2. Expose the wound.

*NOTE:* Remove all clothing around the wound to fully expose wound.

3. Pack the wound with combat gauze.
  - a. Using the four “P’s” of packing (peel, push, pile, and pressure) pack the gauze directly into the wound.
  - b. Hold pressure for a minimum of 3 minutes.
  - c. Pack with kerlix if required.
4. Place 6 inch elastic bandage over shoulder, leaving a tail facing posterior. With remainder of elastic bandage completely cover packing material, wrapping in an anterior direction.
5. Wrap around injured shoulder twice ensuring to pull elastic bandage taut over covered packing material.
6. Wrap across back anchoring on opposite shoulder in a “figure 8” pattern, while maintaining tension.
7. Tie tails together with a non-slip knot.
8. Secure elastic bandage tails and knot with 2 or 3 inch tape by wrapping 1-1/2 times around tail and knot.
9. Swathe arm to torso to provide additional pressure to wound.
10. Continue to assess wound for further bleeding.

### Evaluation Preparation:

**Setup:** For training and evaluation, use another Soldier to simulate a casualty with an axillary wound.

**Brief Soldier:** Tell the Soldier the simulated requires treatment for an axillary wound.

<b>Performance Measures</b>	GO	NO GO
1 Took body substance isolation.	_____	_____
2 Exposed the wound.	_____	_____
3 Packed the wound with combat gauze and held pressure for 3 minutes.	_____	_____
4 Placed 6 inch elastic bandage over shoulder leaving tail on posterior side.	_____	_____
5 Wrapped elastic bandage around injured shoulder twice.	_____	_____

<b>Performance Measures</b>	GO	NO GO
6    Wrapped elastic bandage across back anchoring on opposite shoulder in a "figure 8" pattern.	_____	_____
7    Tied tails of elastic bandage together with a non-slip knot.	_____	_____
8    Secured tails and knot using 3 inch tape 1 -1/2 times around.	_____	_____
9    Swathed arm to torso.	_____	_____
10   Continued to assess wound for further bleeding.	_____	_____

**Evaluation Guidance:** Score each Soldier according to the performance measures. Unless otherwise stated in the task summary, the Soldier must pass all performance measures to be scored GO. If the Soldier fails any steps, show what was done wrong and how to do it correctly.

**References**

**Required**  
None

**Related**  
None

## Initiate Treatment for an Open Abdominal Wound

081-833-0028

**Conditions:** You have a casualty with an open abdominal wound. All other more serious injuries have been assessed and treated. You will need field dressings, sterile abdominal dressings, cravats, scissors, gauze, saline solution, intravenous (IV) equipment, and DD Form 1380 US Field Medical Card (FMC). You are not in a CBRN environment.

**Standards:** Initiate treatment to an open abdominal wound, minimize the effects of the injury, and stabilize the casualty without causing additional injury.

### Performance Steps

1. Position the casualty.
  - a. Place the casualty on his back (face up).
  - b. Flex the casualty's knees.
  - c. Turn the casualty's head to the side and keep the airway clear if vomiting occurs.

**WARNING:** The most important concern in the initial management of abdominal injuries is shock. Shock may be present initially or develop later. Neither the presence or absence of a wound, nor the size of the external wound are safe guidelines for judging the severity of the wound.

2. Initiate treatment for shock. (See task 081-833-0047.)

**CAUTION:** Do not attempt to replace protruding internal organs or remove any protruding foreign objects.

3. Expose the wound. Inspect for distention, contusions, penetration, eviscerations or obvious bleeding.
4. Stabilize any protruding objects. (See task 081-833-0029.)
5. Apply a sterile abdominal dressing.

**NOTE:** Protruding abdominal organs should be kept moist to prevent the tissue from drying out. A moist, sterile dressing should be applied if available.

- a. Using the sterile side of the dressing, or other clean material, place any protruding organs near the wound.
- b. Ensure that the dressing is large enough to cover the entire mass of protruding organs or area of the wound.
- c. If large enough to cover the affected area, place the sterile side of the plastic wrapper directly over the wound.
- d. Place the dressing directly on top of the wound or plastic wrapper, if used.

**CAUTION:** Do not apply pressure on the wound or expose internal parts.

- e. Tie the dressing tails loosely at the casualty's side.
  - f. If two dressings are needed to cover a large wound, repeat steps 5a through 5e. Ensure that the ties of additional dressings are not tied over each other.
  - g. If necessary, loosely cover the dressings with cravats. Tie them on the side of the casualty opposite that of the dressing ties.
6. Do not cause further injury to the casualty.

- a. Do not touch any exposed organs with bare hands.
- b. Do not try to push any exposed organs back into the body.
- c. Do not tie the dressing tails tightly or directly over the dressing.
- d. Do not give the casualty anything by mouth.

*NOTE:* Continue to assess the casualty.

- 7. Prepare the casualty for evacuation.
  - a. Place the casualty on his back (face up) with the knees flexed.
  - b. If evacuation is delayed, check the casualty for signs of shock every 5 minutes.
- 8. Record the treatment given on the FMC.

**Evaluation Preparation:**

Setup: For training and evaluation, have another Soldier act as the casualty. Tell the medic the casualty has an open abdominal injury and to treat the casualty.

<b>Performance Measures</b>	GO	NO GO
1 Positioned the casualty.	_____	_____
2 Initiated treatment for shock.	_____	_____
3 Exposed the wound.	_____	_____
4 Stabilized any protruding objects.	_____	_____
5 Applied a sterile abdominal dressing.	_____	_____
6 Did not cause further injury to the casualty.	_____	_____
7 Prepared the casualty for evacuation.	_____	_____
8 Recorded the treatment given on the FMC.	_____	_____

**Evaluation Guidance:** Score each Soldier according to the performance measures. Unless otherwise stated in the task summary, the Soldier must pass all performance measures to be scored GO. If the Soldier fails any steps, show what was done wrong and how to do it correctly.

**References**

**Required**  
DD Form 1380

**Related**  
None

## Initiate Treatment for an Impaled Object

081-833-0029

**WARNING:** Do not exert any force on or attempt to remove the impaled object unless the object is impaled in the cheek and both ends of the object can be seen or unless the object is blocking the airway. Severe bleeding or nerve and muscle damage may result.

**Conditions:** You have a casualty with an impalement injury. You will need field dressings, cravats, bandages, gauze, scissors, splinting equipment, sling, oxygen delivery device, pen and a DD Form 1380 US Field Medical Card (FMC). You have managed all other immediate life threats, performed a patient care hand wash and are not in a CBRN environment.

**Standards:** Initiate treatment of the impalement, and minimize the effect of the injury without causing further injury to the casualty.

### Performance Steps

1. Position the casualty.
  - a. Tell the casualty to remain still and not to move the impaled object.
  - b. Expose the injury by cutting away or removing clothing or equipment around the wound site.
  - c. If the impalement injury is on an extremity, check the pulse distal to the injury site.
  - d. If the impalement is found in the cheek and both ends of the object can be seen.
    - (1) Remove the object in the direction it entered the cheek.
    - (2) Position the casualty to allow for drainage and be prepared to suction the casualty.
  - e. If both ends of the object in the cheek cannot be seen, go to step 2.
2. Immobilize the impaled object.

**NOTE:** If an assistant is available, one person should immobilize the object while the other applies the dressings and bandages.

**WARNING:** Do not exert force on the impaled object.

- a. If necessary, apply direct pressure using gloved hands on either side of the object.
  - b. Place several layers of bulky dressing around the injury site so that the dressings surround the object.
  - c. Use additional bulky materials or dressings to build up the area around the object.
3. Apply the support bandages.

- a. Apply the bandage over the bulky support material to hold it in place.

**WARNING:** Do not anchor the bandage on or exert pressure on the impaled object.

- b. Apply the bandage tightly but not so tight as to impair circulation or breathing.
- c. Check circulation after applying the support bandages.

**NOTE:** If a pulse was palpated in step 1c and it cannot be palpated after the bandage has been applied, the bandage must be loosened until a pulse can be palpated.

**WARNING:** Do not anchor a splint or sling to the impaled object. Avoid undue motion of the



impaled object when applying a splint.

4. Immobilize the affected area with a splint or sling, if applicable.
5. Check for a pulse distal to the injury site.
6. Provide oxygen.
7. Treat for shock, if necessary.
8. Consider pain management as necessary. (See task 081-833-0174.)
9. Record the treatment on the FMC.
10. Evacuate the casualty.

### Evaluation Preparation:

Setup: For training and evaluation, have another Soldier act as the casualty. Use a moulage set or similar materials to create a simulated impalement injury. You may also have another Soldier assist in immobilizing the object.

Brief Soldier: Tell the Soldier to treat the casualty for an impalement injury and to direct the actions of the assistant, if applicable. Tell the Soldier that they are not in a CBRN environment.

<b>Performance Measures</b>	GO	NO GO
1 Positioned the casualty.	_____	_____
2 Immobilized the impaled object.	_____	_____
3 Applied the support bandages.	_____	_____
4 Immobilized the affected area with a splint or sling, if applicable.	_____	_____
5 Checked for a pulse distal to the injury site.	_____	_____
6 Provided oxygen.	_____	_____
7 Treated for shock, if necessary.	_____	_____
8 Considered pain management as necessary.	_____	_____
9 Recorded the treatment on the FMC.	_____	_____
10 Evacuated the casualty.	_____	_____
11 Did not cause further injury to the casualty.	_____	_____

**Evaluation Guidance:** Score each Soldier according to the performance measures. Unless otherwise stated in the task summary, the Soldier must pass all performance measures to be scored GO. If the Soldier fails any steps, show what was done wrong and how to do it correctly.

### References

**Required**  
DD Form 1380

**Related**  
None

## Initiate Treatment for a Head Injury

081-833-0038

**WARNING:** Treat casualties with any type of traumatic head injury or loss of consciousness as if they have a spinal injury. (See task 081-833-0267.)

**Conditions:** You have a casualty with a head injury. You will need field dressings, cravats, stethoscope, sphygmomanometer, cervical collar, oxygen tank set up, suction equipment, oropharyngeal airway, non-rebreather mask, pen and DD Form 1380 US Field Medical Card (FMC). All other immediate life threats have been assessed and treated. You have performed a patient carehand wash and you are not in a CBRN environment.

**Standards:** Initiate treatment of the head injury and stabilize the casualty without causing additional injury.

### Performance Steps

1. Take appropriate body substance isolation (BSI) precautions.
2. Check for the signs and symptoms of head injuries.

**WARNING:** Brain injury, leading to a loss of function or death, often occurs without evidence of a skull fracture or scalp injury. Because the skull cannot expand, swelling of the brain or a collection of fluid pressing on the brain can cause pressure. This can compress and destroy the brain tissue.

a. Closed head injury--caused by a direct blow to the head.

- (1) Deformity of the head.
- (2) Clear fluid or blood escaping from the nose and/or ear(s).
- (3) Periorbital discoloration (raccoon eyes).
- (4) Bruising behind the ears, over the mastoid process (battle sign).
- (5) Lowered pulse rate if the casualty has not lost a significant amount of blood.
- (6) Signs of increased intracranial pressure.
  - (a) Headache, nausea, and/or vomiting.
  - (b) Possible unconsciousness.
  - (c) Change in pupil size or symmetry.
  - (d) Lateral loss of motor nerve function-one side of the body becomes paralyzed.

**NOTE:** Lateral loss may not happen immediately but may occur later.

- (e) Change in the casualty's respiratory rate or pattern.
  - (f) A steady rise in the systolic blood pressure if the casualty hasn't lost significant amounts of blood.
  - (g) A rise in the pulse pressure (systolic pressure minus diastolic pressure).
  - (h) Elevated body temperature.
  - (i) Restlessness-indicates insufficient oxygenation of the brain.

b. Concussion-caused by a violent jar or shock.

**NOTE:** A direct blow to the skull may bruise the brain.

- (1) Temporary unconsciousness followed by confusion.
- (2) Temporary, usually short term, loss of some or all brain functions.
- (3) The casualty has a headache or is seeing double.
- (4) The casualty may or may not have a skull fracture.

c. Contusion-an internal bruise or injury. It is more serious than a concussion. The injured tissue may bleed or swell. Swelling may cause increased intracranial pressure that may result in a decreased level of consciousness and even death.

d. Open head injury.

- (1) Penetrating wound-an entry wound with no exit wound.
- (2) Perforating wound-the wound has both entry and exit wounds.
- (3) Visibly deformed skull.
- (4) Exposed brain tissue.
- (5) Possible unconsciousness.
- (6) Paralysis or disability on one side of the body.
- (7) Change in pupil size.
- (8) Lacerated scalp tissue-may have extensive bleeding.

3. Direct manual stabilization of the casualty's head.

4. Assess the casualty's level of consciousness (LOC) by the following methods.

a. AVPU Method.

(1) Does the casualty know their name, date or time; location and events leading up to the injury, (Alert and oriented (A&O) x four)?

(2) Does the casualty respond to verbal stimuli/commands?

(3) Does the casualty respond to painful stimulus?

(4) Is the casualty unconscious?

b. Glasgow Coma Scale (GCS).

*NOTE:* The Glasgow Coma Scale (GCS) score is calculated by using the best response noted while evaluating the casualty's eyes, verbal response and motor response. A baseline GCS should be calculated to assess the casualty's LOC accurately. The highest possible score a casualty can receive is 15 and the lowest possible score is 3.

(1) Eye opening.

(2) Verbal response.

(3) Motor response.

5. Initiate treatment for the head injury.

a. Superficial head injury.

(1) Apply a dressing.

(2) Observe for abnormal behavior or evidence of complications.

b. Head injury involving trauma.

(1) Maintain a patent airway using the jaw thrust maneuver. (See task 081-831-0018.)

(2) If the casualty is unconscious, insert an oropharyngeal airway without hyperextending the neck. (See task 081-833-0016.)

(3) Administer high concentration oxygen by bag valve mask (see task 081-833-0158), if airway is not patent. If airway is patent, administer oxygen by non-rebreather mask. (See task 081-833-0017.)

(4) Observe the size of each pupil by shining a light in each eye to observe the pupillary reaction to the light.

*NOTE:* The pupils should constrict promptly when exposed to bright light. Failure of the pupils to constrict may indicate brain injury.

(5) Apply a cervical collar. (See task 081-833-0177.)

(6) Dress the head wound(s).

**WARNING:** Do not apply pressure to or replace exposed brain tissue.

(7) Control bleeding. (See task 081-833-0124.)

(8) Treat for shock.

(9) Monitor the casualty for convulsions or seizures. (See task 081-831-0035.)

(10) A casualty with no suspected c-spine injury can have the head elevated 6 inches to assist with drainage of blood from the brain.

**CAUTION:** Do not give the casualty anything by mouth (NPO).

(11) A casualty with a suspected c-spine injury should be placed on a long spine board. (See task 081-833-0181.)

6. Monitor unstable casualties every 5 minutes and document findings.

- a. Level of consciousness.
- b. Pupillary responsiveness and equality.
- c. Vital signs.
- d. Motor functions.

(1) Evaluate the casualty's strength, mobility, coordination and sensation.

(2) Document any complaints, weakness, or numbness.

7. Record the treatment on the FMC.

8. Evacuate the casualty.

*NOTE:* Casualty should be facing you during transport. It is much easier to monitor and manage their airway if you can see it all times. Have suction readily available. (See task 081-833-0021.)

### **Evaluation Preparation:**

Setup: For training and evaluation, have another Soldier act as the casualty. Use a moulage kit or similar materials to simulate a head wound. To test steps 2 and 7, coach the simulated casualty on how to answer the Soldier's questions regarding such symptoms as headache. Tell the Soldier what signs, such as changes in pupil size, the casualty is exhibiting.

Brief Soldier: Tell the Soldier to identify the type of head injury and initiate treatment for the head injury.

<b>Performance Measures</b>	GO	NO GO
1 Took appropriate BSI procedures.	_____	_____
2 Checked for the signs and symptoms of head injuries.	_____	_____
3 Directed manual stabilization of the casualty's head.	_____	_____
4 Assessed the casualty's level of consciousness (LOC).	_____	_____
5 Initiated treatment of the head injury.	_____	_____
6 Continued to monitor the casualty at 5 minute intervals.	_____	_____
7 Recorded the treatment on the FMC.	_____	_____
8 Evacuated the casualty.	_____	_____
9 Did not cause further injury to the casualty.	_____	_____

**Evaluation Guidance:** Score each Soldier according to the performance measures. Unless otherwise stated in the task summary, the Soldier must pass all performance measures to be scored GO. If the Soldier fails any steps, show what was done wrong and how to do it correctly.

#### References

**Required**  
DD Form 1380

**Related**  
None

## Initiate Treatment for Foreign Bodies of the Eye

081-833-0039

**WARNING:** Wear gloves for self-protection against transmission of contaminants whenever handling body fluids.

**Conditions:** You have a casualty with a foreign body in his eye. All other more serious injuries have been assessed and treated. You have performed a patient care handwash. You will need cotton-tipped swabs, clean cloth, sterile irrigation solution (normal saline, water, or other prescribed solution), bandages, dry sterile dressings, eye patch, a paper cup or cardboard cone, and DD Form 1380 US Field Medical Card (FMC). You are not in a CBRN environment.

**Standards:** Initiate treatment for foreign bodies of the eye, minimizing the effects of the injury and without causing additional injury to the eye.

### Performance Steps

1. Perform visual acuity testing. (See task 081-833-0193.)
2. Assess eyes: pupils, equal, round, reactive to light (PERRL).
3. Locate the foreign body.
  - a. Method one.
    - (1) Pull the lower lid down.
    - (2) Tell the casualty to look up and to both sides and check for foreign bodies.
    - (3) Pull the upper lid up.
    - (4) Tell the casualty to look down and to both sides and check for foreign bodies.
  - b. Method two.
    - (1) Tell the casualty to look down.
    - (2) Grasp the casualty's upper eyelashes and gently pull the eyelid away from the eyeball.
    - (3) Place a cotton-tipped swab horizontally along the outer surface of the upper lid and fold the lid back over the swab.
- CAUTION:** If the foreign bodies cannot be located, bandage both eyes and seek further medical aid immediately.
  - (4) Look for the foreign bodies or damage on the globe.
- CAUTION:** Do not put pressure on the globe.
4. Remove the foreign body.
  - a. Small foreign body on an anterior surface.
    - (1) Hold the casualty's eye open.
    - (2) Irrigate the eye. (See task 081-833-0054.)
  - b. Foreign body stuck to the cornea or lying under the upper or lower eyelid.
    - (1) For a foreign body under the lower eyelid, pull the lower lid down.
    - (2) For a foreign body under the upper eyelid, pull the upper lid up.

**CAUTION:** Bandage both eyes if foreign bodies are not easily removed by these methods or if there is pain or loss of vision in the eye. Seek further medical aid immediately.

- (3) Remove the foreign body with a moistened, sterile cotton-tipped swab.

*NOTE:* In hazardous conditions, leave the good eye uncovered long enough to ensure the casualty's safety.

**CAUTION:** Do not attempt to remove a foreign body stuck to or sticking into the eyeball. A medical officer must remove such objects.

- c. Foreign body stuck or impaled in the eye.

- (1) Apply dry sterile dressings to build around and support the object.

*NOTE:* This will help prevent further contamination and minimize movement of the object.

- (2) Cover the injured eye with a paper cup or cardboard cone.

- (3) Cover the uninjured eye with a dry dressing or eye patch.

- (4) Reassure the casualty by explaining why both eyes are being covered.

*NOTE:* The eyes move together. If the casualty uses (moves) the uninjured eye, the injured eye will move as well. Covering both eyes will keep them still and will prevent undue movement on the injured side.

- (5) Seek further medical aid immediately.

- 5. Obtain details about the injury.

- a. Source and type of the foreign bodies.
- b. Whether the foreign bodies were wind-blown or high velocity.
- c. Time of onset and length of discomfort.
- d. Any previous injuries to the eye.

- 6. Record the procedure on the FMC.

- 7. Evacuate the casualty, as required.

- 8. Do not cause additional injury to the eye.

- a. Do not probe for foreign bodies.
- b. Do not put pressure on the globe.
- c. Do not remove an impaled object.

**Evaluation Preparation:** None.

<b>Performance Measures</b>	GO	NO GO
1 Performed visual acuity testing.	_____	_____
2 Assessed PERRL	_____	_____
3 Located the foreign body.	_____	_____
4 Removed the foreign body.	_____	_____
5 Obtained details about the injury.	_____	_____

**Performance Measures**

GO            NO GO

6 Recorded the procedure on the FMC.

\_\_\_\_\_

7 Evacuated the casualty, as required.

\_\_\_\_\_

8 Did not cause additional injury to the eye.

\_\_\_\_\_

**Evaluation Guidance:** Score each Soldier according to the performance measures. Unless otherwise stated in the task summary, the Soldier must pass all performance measures to be scored GO. If the Soldier fails any steps, show what was done wrong and how to do it correctly.

**References**

**Required**  
DD Form 1380

**Related**  
None



## Initiate Treatment for Lacerations of the Eyelid

081-833-0040

**Conditions:** You have a casualty with a laceration of the eyelid. All other more serious injuries have been assessed and treated. You have performed a patient care hand wash. You will need cotton-tipped swabs, clean cloth, sterile irrigation solution (normal saline, water, or other prescribed solution), bandages, dry sterile dressings, eye patch, a paper cup or cardboard cone and DD Form 1380 US Field Medical Card, (FMC). You are not in a CBRN environment.

**Standards:** Initiate treatment for the eyelid laceration without causing additional injury to the eye.

### Performance Steps

1. Position the casualty and remove his headgear, if necessary.
  - a. Conscious casualty will be placed in a seated position.
  - b. Unconscious casualties will be placed in a supine position with the head slightly elevated.
2. If conscious, perform visual acuity testing. (See task 081-833-0193.)
3. Assess eyes: pupils, equal and round, regular in size, and react to light (PERRL).
4. Examine the eyes for the following:
  - a. Objects protruding from the globe.
  - b. Look for foreign bodies or damage on the globe.
  - c. Swelling or lacerations on the globe.
  - d. Bloodshot appearance of the sclera.
  - e. Bleeding.
    - (1) Surrounding the eye.
    - (2) Inside the globe.
    - (3) Coming from the globe.
  - f. Contact lenses. Ask the casualty if he is wearing contact lenses but do not force the eyelids open. Record that they are being worn, if appropriate.
5. Categorize the injury.
  - a. Injury to the tissue surrounding the eye (lacerations and contusions).
  - b. Injury to the globe.
  - c. Extrusion.
  - d. Foreign bodies. (See task 081-833-0039.)
  - e. Protruding (impaled) objects.
6. Treat the injury.

**NOTE:** Torn eyelids should be handled carefully. Wrap any detached fragments in a separate moist dressing and evacuate with the casualty.

- a. Control bleeding with light pressure from a dressing; use no pressure at all if you suspect that the eyeball itself has been injured.

- b. Cover the eyelid with sterile gauze soaked in saline to keep the wound from drying.
- c. Preserve any avulsed skin and transport it with the casualty for possible grafting.
- d. If penetrating eyeball injury is not suspected, cover the injured eyelid with cold compresses to reduce swelling.
- e. Cover the uninjured eye with a bandage to decrease movement, and transport.

**NOTE:** In hazardous conditions, leave the good eye uncovered long enough to ensure the casualty's safety.

- 7. Record the procedure on the FMC.
- 8. Evacuate the casualty.
  - a. Transport the casualty on his back, with the head elevated and immobilized.
  - b. Evacuate eyeglasses with the casualty, even if they are broken.
- 9. Did not cause additional injury to the eye.

**Evaluation Preparation:**

Setup: For training and evaluation, have another Soldier act as the casualty. Use a moulage kit or similar material to simulate the injury or describe the type of injury to the Soldier.

Brief Soldier: Tell the Soldier to treat the eye injury.

<b>Performance Measures</b>	GO	NO GO
1 Positioned the casualty.	_____	_____
2 Performed visual acuity testing.	_____	_____
3 Assessed PERRL.	_____	_____
4 Examined the eyes.	_____	_____
5 Categorized the injury.	_____	_____
6 Treated the injury.	_____	_____
7 Recorded the procedure on the FMC.	_____	_____
8 Evacuated the casualty.	_____	_____
9 Did not cause further injury to the casualty.	_____	_____

**Evaluation Guidance:** Score each Soldier according to the performance measures. Unless otherwise stated in the task summary, the Soldier must pass all performance measures to be scored GO. If the Soldier fails any steps, show what was done wrong and how to do it correctly.

**References**

**Required**  
DD Form 1380

**Related**  
None

## Initiate Treatment for Extrusions of the Eye

**081-833-0042**

**Conditions:** You have a casualty with an ocular extrusion. All other more serious injuries have been assessed and treated. You have performed a patient care handwash. You will need cotton-tipped swabs, clean cloth, sterile irrigation solution (normal saline, water, or other prescribed solution), bandages, dry sterile dressings, eye patch, a paper cup or cardboard cone, pen, and DD Form 1380 US Field Medical Card (FMC). You are not in a CBRN environment.

**Standards:** Initiate treatment of the extrusion without causing additional injury to the eye.

### Performance Steps

1. Position the casualty and remove his headgear, if necessary.
  - a. Conscious-seated.
  - b. Unconscious-lying on his back with the head slightly elevated.
2. If conscious, perform visual acuity testing. (See task 081-833-0193.)
3. Assess eyes: pupils, equal and round, regular in size, and react to light (PERRL).
4. Examine the eyes for the following:
  - a. Objects protruding from the globe.
  - b. Swelling or lacerations on the globe.
  - c. Bloodshot appearance of the sclera.
  - d. Bleeding.
    - (1) Surrounding the eye.
    - (2) Inside the globe.
    - (3) Coming from the globe.
  - e. Contact lenses. Ask the casualty if he is wearing contact lenses but do not force the eyelids open. Record that they are being worn, if appropriate.
  - f. Extrusion (the eye is protruding from the socket).

**CAUTION:** Do not attempt to reposition the globe or replace it in the socket.

5. Treat the injury.
  - a. Position the casualty face up.
  - b. Cut a hole in several layers of dressing material, and then moisten it. Use sterile liquid, if available.
  - c. Place the dressing so the injured globe protrudes through the hole, but does not touch the dressing. The dressing should be built up higher than the globe.

*NOTE:* If available, place a paper cup or cone-shaped piece of cardboard over the eye. Do not apply pressure to the injury site. Apply roller gauze to hold the cup in place.

- d. Cover the uninjured eye to prevent sympathetic eye movement.

*NOTE:* In hazardous conditions, leave the good eye uncovered long enough to ensure the casualty's safety.

6. Record the procedure on the FMC.

7. Evacuate the casualty.
  - a. Transport the casualty on his back, with the head elevated and immobilized.
  - b. Evacuate eyeglasses with the casualty, even if they are broken.

8. Do not cause further injury to the casualty.

**Evaluation Preparation:**

Setup: For training and evaluation, have another Soldier act as the casualty. Use a moulage kit or similar material to simulate the injury, or describe the type of injury to the Soldier.

Brief Soldier: Tell the Soldier to initiate treatment for the eye extrusion.

<b>Performance Measures</b>	GO	NO GO
1 Positioned the casualty.	_____	_____
2 Performed visual acuity testing.	_____	_____
3 Assessed PERRL.	_____	_____
4 Examined the eyes.	_____	_____
5 Treated the injury.	_____	_____
6 Recorded the procedure on the FMC.	_____	_____
7 Evacuated the casualty.	_____	_____
8 Did not cause further injury to the casualty.	_____	_____

**Evaluation Guidance:** Score each Soldier according to the performance measures. Unless otherwise stated in the task summary, the Soldier must pass all performance measures to be scored GO. If the Soldier fails any steps, show what was done wrong and how to do it correctly.

**References**

**Required**  
DD Form 1380

**Related**  
None

## Initiate Treatment for Burns

**081-833-0051**

**Conditions:** You have encountered a casualty with a burn. You will need trauma dressings, sterile dressings, Kerlix, intravenous (IV) fluids such as ringer's lactate or normal saline, water, non-petroleum liquid (water or mud), oxygen, sterile sheet or clean linen, 16 or 18 gauge IV catheter needle, an IV setup, pen an DD Form 1380 US Field Medical Card (FMC). You have treated all other immediate life threats, performed a patient care hand wash, taken appropriate body substance isolation precautions (BSI) and are not in a CBRN environment.

**Standards:** Initiate treatment of the casualty's burn according to the type and extent of the burn. Stabilize the casualty without causing further injury to the casualty or to self.

### Performance Steps

1. Determine the cause of the burns.
  - a. Assess the scene.
  - b. Question the casualty and/or bystanders.
  - c. Determine if the casualty has been exposed to smoke, steam, or combustible products.
  - d. Determine if the cause was open flame, hot liquid, chemicals, or electricity.
  - e. Determine whether the casualty was struck by lightning.

*NOTE:* If the burn was caused by an explosion or lightning, the casualty may also have been thrown some distance from the original spot of the incident. He may, therefore, have associated internal injuries, fractures, or spinal injuries.

2. Stop the burning process.
  - a. Thermal burns.
    - (1) Have the casualty STOP, DROP, and ROLL.
      - (a) Do not permit the casualty to run, as this will fan the flames.
      - (b) Do not permit the casualty to stand, as the flames may be inhaled or the hair ignited.
      - (c) Place the casualty on the ground or floor and roll the casualty in a blanket or in dirt, and/or splash with water.
    - (2) Remove all smoldering clothing and articles that retain heat, if possible.

**CAUTION:** Do not remove clothing that is stuck to the burned area. If the clothing and skin are still hot, irrigate with copious amounts of room-temperature water or cover with a wet dressing, if available.

- (3) Cut away clothing to expose the burned area.

- b. Electrical burns.

**WARNING:** Do not directly touch a casualty receiving a shock. To do so will conduct the current to you.

- (1) Turn off the current, if possible.

**WARNING:** Electrical shock may cause the casualty to go into cardiac arrhythmia or arrest. Initiate cardiopulmonary resuscitation (CPR) as appropriate. Casualties of lightning strikes may

require prolonged CPR and extended respiratory support.

- (2) If necessary and/or possible, remove the electrical source from the casualty.

**WARNING:** A chemical will burn as long as it is in contact with the skin.

c. Chemical burns.

- (1) Flush the area of contact immediately with water. When flushing, be careful not to let the run off contaminate other areas of the body. Do not delay flushing by removing the casualty's clothing first.

*NOTE:* If a solid chemical, such as lime, has been spilled on the casualty, brush it off before flushing. A dry chemical is activated by contact with water and will cause more damage to the skin.

**WARNING:** Do not use a hard blast of water. Extreme water pressure can add mechanical injury to the skin.

- (2) Flush with cool water for 10 to 15 minutes while removing contaminated clothing or other articles.

*NOTE:* Flush longer for alkali burns because they penetrate deeper and cause more severe injury.

Many chemicals have a delayed reaction. They will continue to cause injury even though the casualty no longer feels pain.

d. White phosphorus burns.

*NOTE:* White phosphorus (WP) will stick to the skin and continue to burn until it is deprived of air. WP burns are usually multiple and deep, usually producing second and third degree burns.

- (1) Deprive the WP of oxygen.

- (a) Splash with a nonpetroleum liquid (such as water, mud, or urine).

- (b) Submerge the entire area.

- (c) Cover the affected area with a moistened cloth, if available, or mud.

- (2) Remove the WP particles from the skin by brushing with a wet cloth or using forceps, stick, or knife.

3. Maintain an open airway, if necessary. (See task 081-831-0018.)

*NOTE:* As long as 30 to 40 minutes may elapse before edema obstructs the airway and respiratory distress is noted. Always suspect an inhalation injury with a closed-space fire.

- a. Check for signs and symptoms of inhalation injury.

- (1) Facial burns.

- (2) Singed eyebrows, eyelashes, and/or nasal hairs.

- (3) Carbon deposits and/or redness in the mouth and/or oropharynx.

- (4) Sooty carbon deposits in the sputum.

- (5) Hoarseness, noisy inhalation, cough, or dyspnea.

- b. Check for signs and symptoms of carbon monoxide poisoning.

- (1) Dizziness, nausea, and/or headache.

- (2) Cherry-red colored skin and mucous membranes.
- (3) Tachycardia or tachypnea.
- (4) Respiratory distress or arrest.
- c. Administer humidified oxygen at a high flow rate. (See tasks 081-833-0018 and 081-833-0158.)
- 4. Determine the percent of body surface area (BSA) burned.
  - a. Cut the casualty's clothing away from the burned areas.
  - b. Determine the percentage of BSA burned using the Rule of Nines. (See Figure 3-1.)

<b>Rule of Nines</b>		
<b>1. Head and neck</b>	<b>=</b>	<b>9%</b>
<b>2. Anterior trunk</b>	<b>=</b>	<b>18%</b>
<b>3. Posterior trunk</b>	<b>=</b>	<b>18%</b>
<b>4. Upper extremities</b>	<b>=</b>	<b>18% (each 9%)</b>
<b>5. Lower extremities</b>	<b>=</b>	<b>36% (each 18%)</b>
<b>6. Perineum</b>	<b>=</b>	<b>1%</b>

Figure 3-1. Rule of Nines

- 5. Determine the degree of the burn.
  - a. First degree.
    - (1) Superficial skin only.
    - (2) Red and painful, like a sunburn.

b. Second degree.

- (1) Partial thickness of the skin.
- (2) Penetrates the skin deeper than first degree.
- (3) Blisters and pain.
- (4) Some subcutaneous edema.

c. Third degree.

- (1) Damage to or the destruction of a full thickness of skin.
- (2) Involves underlying muscles, bones, or other structures.
- (3) The skin may look leathery, dry, and discolored (charred, brown, or white).
- (4) Nerve ending destruction causes a lack of pain.
- (5) Massive fluid loss.
- (6) Clotted blood vessels may be visible under the burned skin.

**CAUTION:** Check for entry and exit burns when treating electrical burns and lightning strikes.

The amount of injured tissue in an electrical burn is usually far more extensive than the appearance of the wound would indicate. Although the burn wounds may be small, severe damage may occur to deeper tissues. (High voltage can destroy skin and muscles to such an extent that amputation may eventually be necessary.)

- (7) Subcutaneous fat may be visible.

6. Treat for shock those casualties who have second or third degree burns of 20% BSA or more.

- a. Initiate treatment for hypovolemic shock. (See task 081-833-0047.)
- b. Keep the casualty flat.
- c. Initiate an IV infusion. (See task 081-833-0033.)

- (1) Use ringer's lactate, if available. Normal saline is the second fluid of choice.

**CAUTION:** Do not give more than 1,000 ml of Hextend® to a casualty.

(2) If the casualty is in shock secondary to other injuries, IV may be started with Hextend.

- (3) Use a large gauge (#16 or #18) needle.
- (4) Initiate the IVs in an unburned area, if possible.
- (5) Use large peripheral veins.

**NOTE:** The presence of overlying burned skin should not deter the use of an accessible vein. The upper extremities are preferable to lower extremities.

- d. Infuse fluids for a casualty based on Rule of Tens.

**NOTE:** The objective is to determine an appropriate rate or amount of fluids to prevent hypovolemia after burn injury. Initiate fluid resuscitation as soon as intravenous/intraosseous (IV/IO) access is established.

(1) Estimate the total body surface area (TBSA) burned to the nearest 10% (using the Rule of Nines or Rule of Palm).



(2) Percentage TBSA (to the nearest 10%) x 10 ml/hr for adults weighing 88-176 pounds.

(a) Example: 170 pound male has burned approximately 30% of his body.

(b)  $30 \text{ (TBSA\%)} \times 10 \text{ ml/hour} = 300 \text{ ml/hour}$ .

(3) For every 25 pounds above 175, increase the initial rate by 100 ml/hour.

(a) Example: A 195 pound male has burned approximately 50% of his TBSA.

(b)  $50 \text{ (TBSA\%)} \times 10 \text{ ml/hour} = 500 \text{ ml/hour} + 100 \text{ ml/hour} = 600 \text{ ml/hour}$ .

(4) Assess the circulatory blood volume.

*NOTE:* Urine output is a reliable guide to assess circulating blood volume.

(a) Measure the casualty's urine output in cc per hour.

(b) Adjust the IV fluid flow to maintain 30 to 50 cc of urine output per hour.

7. Perform either an EMT Trauma Assessment or a Combat Casualty Assessment depending on the situation. (See tasks 081-833-0053, 081-833-0067.)

a. Measure and record the casualty's vital signs.

b. Assess the casualty for associated injuries.

c. Check the distal circulation by checking pulses in all extremities.

**CAUTION:** The swelling of burns on extremities can cause a tourniquet-like effect, and the swelling of a burned throat can impair breathing.

8. Remove potentially constricting items such as rings and bracelets.

9. Dress the burns.

a. Apply a dry sterile dressing to the burns.

b. Cover extensive burns with a sterile sheet, if available, or clean linen.

10. Record the treatment given on the FMC.

11. Evacuate the casualty.

12. Do not cause further injury to the patient.

### **Evaluation Preparation:**

Setup: For training and evaluation, have another Soldier act as the casualty. You may use a moulage kit or similar material to simulate burns on the casualty, or you may describe to the Soldier the area(s) of the body burned. Create a scenario which describes the cause and depth of the burns. For step 2, have the Soldier describe what actions should be taken to prevent further injury. To test step 5, describe the depth of the burns and have the Soldier tell you if they are first, second, or third degree.

*NOTE:* When testing step 6, have the Soldier describe what actions should be taken when administering IV therapy, if necessary. When testing step 7, have the Soldier describe what action is taken.

Brief Soldier: Tell the Soldier to determine the extent of the casualty's burns and the treatment required.

<b>Performance Measures</b>	GO	NO GO
1 Determined the cause of the burn.	_____	_____
2 Stopped the burning process.	_____	_____
3 Maintained an open airway, if necessary.	_____	_____
4 Determined the percent of BSA burned.	_____	_____
5 Determined the degree of the burn.	_____	_____
6 Treated the casualty for shock, if necessary.	_____	_____
7 Performed either an EMT Trauma Assessment or a Combat Casualty Assessment.	_____	_____
8 Removed potentially constricting items.	_____	_____
9 Dressed the burns.	_____	_____
10 Recorded the treatment given on the FMC.	_____	_____
11 Evacuated the casualty.	_____	_____
12 Did not cause further injury to the casualty.	_____	_____

**Evaluation Guidance:** Score each Soldier according to the performance measures. Unless otherwise stated in the task summary, the Soldier must pass all performance measures to be scored GO. If the Soldier fails any steps, show what was done wrong and how to do it correctly.

**References**

**Required**  
DD Form 1380

**Related**  
None

## Perform an EMT-B Trauma Assessment

**081-833-0053**

**CAUTION:** All body fluids should be considered potentially infectious. Always observe body substance isolation (BSI) precautions by wearing gloves and eye protection as a minimal standard of protection.

**Conditions:** You encounter a casualty with multiple injuries. You will need sphygmomanometer, stethoscope, airway adjuncts, oxygen, non-rebreathing mask, cervical collar, long spine board, scoop stretcher, and DD Form 1380 US Field Medical Card (FMC). You are not in a CBRN environment.

**Standards:** Assess the casualty, identify all life-threatening injuries, and manage him appropriately without causing further injury to the casualty. Perform the assessment in the correct sequence.

### Performance Steps

1. Take BSI precautions.
2. Perform a Scene Size-Up.
  - a. Determine the safest route to access the casualty.
  - b. Determine the mechanism of injury (MOI).
  - c. Determine the number of casualties.
  - d. Request additional help, if necessary.
  - e. Consider the need for spinal stabilization.

*NOTE:* If the MOI is significant, direct another Soldier to provide manual, in-line stabilization of the cervical spine.

3. Perform an Initial Assessment.

*NOTE:* Life threatening injuries should be managed as they are identified.

- a. Form a general impression (global overview) of the casualty's condition and environment.
- b. Determine the chief complaint.
- c. Assess the airway.
  - (1) Perform appropriate maneuver to open and maintain the airway. (See task 081-831-0018.)
  - (2) Insert an appropriate airway adjunct, if necessary. (See tasks 081-833-0016, 081-833-0142, and 081-833-0169. Also if skill level 30, See task 081-830-3016.)
- d. Assess breathing.
  - (1) Determine the rate, depth and ease of respirations, (breathing).
  - (2) Administer supplemental oxygen by non-rebreathing mask, if available. (See tasks 081-833-0158 and 081-831-0048.)
- e. Assess circulation.
  - (1) Skin color, condition, and temperature (CCT).
  - (2) Assess the pulse for rate, rhythm, and strength.
    - (a) Check the radial pulse in adults.

(b) Check the radial pulse and capillary refill in children.

*NOTE:* Capillary refill should only be checked in children less than 6 years old.

(c) Check the brachial pulse and capillary refill in infants.

(3) Check for significant hemorrhage (bleeding).

(4) Control bleeding. (See tasks 081-833-0161 and 081-833-0212.)

(5) Treat for shock. (See task 081-833-0047.)

f. Assess the casualty's mental status using the Alert, Verbal, Pain, Unresponsive (AVPU) scale.

(1) A - Alert and oriented (eyes open spontaneously as you approach; casualty appears aware and responsive to the environment).

(2) V - Responsive to verbal stimuli (sound).

(3) P - Responsive to painful stimuli (touch, such as tapping the casualty on the shoulder or pinching the casualty's ear).

(4) U - Unresponsive (does not respond to any stimuli).

g. Determine casualty priority and make a transport decision.

*NOTE:* High priority conditions that require immediate transport include a poor general impression, unresponsive, responsive but not following commands, difficulty breathing, shock, complicated childbirth, chest pain with systolic blood pressure less than 100 mm Hg, uncontrolled bleeding, and severe pain.

4. If the MOI is significant, perform a Rapid Trauma Assessment.

*NOTE:* A significant MOI includes ejection from a moving vehicle, death in the same passenger compartment, falls greater than 20 feet, rollover of vehicle, high-speed vehicle collision, vehicle-pedestrian collision, motorcycle crash, trauma resulting in a loss of consciousness or altered mental status, and penetrations of the head, chest, abdomen (e.g., stab and gunshot wounds) or pelvis, and significant blunt trauma to the head, chest, abdomen, or pelvis. Additional significant MOI for a child include falls from more than 10 feet, bicycle collision, and vehicles in medium speed collision.

a. Head.

(1) Inspect for deformities, contusions, abrasions, punctures or penetration, burns, tenderness, lacerations, and swelling (DCAP-BTLS).

(2) Palpate for tenderness, instability, or crepitus (TIC).

b. Neck.

(1) Inspect for DCAP-BTLS.

(2) Palpate spinal step-offs.

(3) Inspect for jugular vein distention (JVD).

(4) Inspect to ensure the trachea is midline (without deviation).

(5) Apply a cervical collar, if necessary.

c. Chest.

(1) Inspect for DCAP-BTLS.

(2) Palpate for TIC.

- (3) Inspect for the presence of paradoxical motion.
- (4) Auscultate (listen) for breath sounds (present, diminished, absent, equal).

d. Abdomen.

- (1) Inspect for DCAP-BTLS.
- (2) Palpate for tenderness, rigidity, and distension and pulsating masses (TRDP).

**CAUTION:** Do not "log roll" casualties suspected of having a pelvic fracture.

e. Pelvis.

*NOTE:* If a conscious casualty complains of pain or if an unconscious casualty responds as if in pain at any time during the assessment, do not continue the exam. Treat for pelvic fracture.

- (1) Inspect for DCAP-BTLS.
- (2) Gently compress (downward or inward) to detect TIC.
- (3) Inspect for priapism (male casualties only), wetness which may be caused by blood or loss of bladder control.

f. Extremities.

- (1) Inspect for DCAP-BTLS.
- (2) Palpate for TIC.
- (3) Assess the hands and feet for circulation, sensation and motor function (CSM).

g. Posterior.

*NOTE:* The casualty must be "log rolled" to do this portion of the assessment. If necessary, the casualty should be placed on a long spine board after assessment. If the Pneumatic Anti-shock Garment (PASG) is deemed necessary, it should be positioned on the long spine board before casualty placement. If the casualty has a suspected pelvic fracture or bilateral femoral fractures, lift the casualty using a scoop stretcher, assess the posterior and place the casualty on the long spine board.

- (1) Inspect for DCAP-BTLS.

*NOTE:* If penetrating wounds were noted during the anterior assessment, check for posterior exit wounds while the casualty is log-rolled/lifted with the scoop stretcher.

- (2) Inspect for wetness which can be caused by loss of bladder control and rectal bleeding.

5. If there is no significant MOI, perform a Focused History and Physical Exam.

a. Based on chief complaint.

b. Focus on the areas the casualty tells you are painful or that you suspect may be painful due to the MOI.

6. Obtain a baseline set of vital signs. (See tasks 081-831-0010, 081-831-0011, 081-831-0012, and 081-831-0013.)

7. Obtain a SAMPLE history.

a. Signs/symptoms.

- (1) Ask the casualty what is wrong.
- (2) Observe the casualty.

- b. Allergies.
  - (1) Ask the casualty if there are any allergies to medications, foods, or environment.
  - (2) Look for a medical identification tag.
- c. Medications.
  - (1) Ask the casualty if he is taking any medications (prescription, over the counter, or illegal).
  - (2) Search for an identification tag with medications on it or medications in the area.
- d. Pertinent past history.
  - (1) Ask the casualty if there are any medical problems (past and present).
  - (2) Ask the casualty if he has been feeling ill.
  - (3) Ask the casualty about recent surgery or injuries.
  - (4) Ask the casualty if he is currently under the care of a medical officer and, if so, what's their name and what type of care is being provided.
- e. Last oral intake.
  - (1) Ask the casualty when his last meal or drink was.
  - (2) Ask the casualty what he ate or drank.
- f. Events leading to the injury or illness.
  - (1) Ask about the sequence of events that led up to the current event.
  - (2) If the casualty is unable to answer, search the scene for anything that may indicate what occurred.
- 8. Perform a detailed physical examination.
  - a. Assess the scalp and cranium.
    - (1) Inspect for DCAP-BTLS.
    - (2) Palpate for TIC.
  - b. Assess the ears.
    - (1) Inspect for DCAP-BTLS.
    - (2) Inspect for drainage.
      - (a) Blood or serous fluids.
      - (b) Clear fluids.
  - c. Assess the face for DCAP-BTLS.
  - d. Assess the eyes.
    - (1) Inspect for DCAP-BTLS.
    - (2) Inspect for discoloration.
    - (3) Inspect for unequal pupils.
    - (4) Inspect for foreign bodies.
    - (5) Inspect for blood in anterior chamber.

## e. Assess the nose.

- (1) Inspect for DCAP-BTLS.
- (2) Inspect for drainage of blood and/or clear fluid.

## f. Assess the mouth.

- (1) Inspect for DCAP-BTLS.
- (2) Inspect for loose or broken teeth.
- (3) Inspect for objects that could cause obstruction.
- (4) Inspect for swelling or laceration of the tongue.
- (5) Inspect for unusual breath odor (alcohol, acetone, etc.).

## g. Assess the neck.

- (1) Inspect for DCAP-BTLS.
- (2) Inspect for JVD.
- (3) Inspect to ensure the trachea is still midline (without deviation).
- (4) Palpate for TIC.

## h. Reassess the chest.

- (1) Inspect for DCAP-BTLS.
- (2) Palpate for TIC.
- (3) Auscultate breath sounds.
- (4) Assess for flail chest.

## i. Reassess the abdomen.

- (1) Inspect for DCAP-BTLS.
- (2) Palpate for TRDP.

## j. Reassess the pelvis.

- (1) Inspect for DCAP-BTLS.
- (2) Inspect for TIC.

## k. Reassess the extremities.

- (1) Inspect for DCAP-BTLS.
- (2) Palpate for TIC.
- (3) Check the CSM.

## l. Reassess the posterior.

*NOTE:* If the casualty is secured to a long spine board, do not remove from the board. Reassess the flanks and as much of the spine as you can without moving the casualty unnecessarily.

- (1) Inspect for DCAP-BTLS.
- (2) Inspect for wetness which can be caused by loss of bladder control and rectal bleeding.

m. Manage secondary injuries and wounds appropriately. (See tasks 081-833-0045, 081-833-0046, 081-833-0049, 081-833-0050, 081-833-0052, 081-833-0056, 081-833-0057, 081-833-0058, 081-833-0060, 081-833-0062, 081-833-0064, 081-833-0154, and 081-833-3011.)

n. Reassess the casualty's vital signs every 5 minutes (if unstable), every 15 minutes (if stable).

9. Document all assessment findings and care provided on the FMC. (See task 081-831-0033.)

**Evaluation Preparation:**

For training and evaluation, have another Soldier act as the casualty or use a trauma mannequin. Describe a general scenario to the Soldier. The casualty must have more than one injury or condition. Wounds may be simulated using moulage or other available materials. A "conscious" casualty can be coached to show signs of such conditions as shock, and to respond to the Soldier's questions about the location of pain and other symptoms of injury. The evaluator will cue the Soldier during the assessment of an "unconscious" casualty as to whether the casualty is breathing, and describe such conditions as shock to the Soldier as they are making the checks. Tell the casualty not to assist the Soldier in any other way.

Brief Soldier: Tell the Soldier to tell you what action he would take for each wound or condition identified.

<b>Performance Measures</b>	GO	NO GO
1 Took BSI precautions.	_____	_____
2 Performed a Scene Size-Up.	_____	_____
3 Performed an Initial Assessment.	_____	_____
4 If the MOI was significant, performed a Rapid Trauma Assessment.	_____	_____
5 If there was no significant MOI, performed a Focused History and Physical Exam.	_____	_____
6 Obtained baseline vital signs.	_____	_____
7 Obtained the SAMPLE history.	_____	_____
8 Performed a detailed physical exam, if appropriate.	_____	_____
9 Documented medical findings and treatment provided on the FMC.	_____	_____

**Evaluation Guidance:** Score each Soldier according to the performance measures in the evaluation guide. Unless otherwise stated in the task summary, the Soldier must pass all performance measures to be scored GO. If the Soldier fails any step, show what was done wrong and how to do it correctly.

**References**

**Required**  
DD Form 1380

**Related**  
None



## Apply an Improvised Tourniquet

**081-833-0066**

**CAUTION:** All body fluids should be considered potentially infectious. Always observe body substance isolation (BSI) precautions by wearing gloves and eye protection as a minimal standard of protection.

**Conditions:** You have a casualty with life-threatening bleeding from an extremity. You will need tape, 2 inches or greater in width, 2 cravats, windlass (made with 8 tongue depressors taped together), pen, market, and DD Form 1380 US Field Medical Card (FMC). You are not in a CBRN environment.

**Standards:** Stop life-threatening hemorrhage with an improvised tourniquet within 90 seconds of encountering the casualty.

**NOTE:** Prior to combat mission, prepare an improvised tourniquet with the following items: 8 tongue depressors taped together, 1 cravat with a full nonslip knot centered and 1 cravat with a half knot.

### Performance Steps

1. Take BSI precautions.

**CAUTION:** A tourniquet should be applied just proximal to the hemorrhaging wound. Leave the tourniquet in open view so it can be monitored for recurrent hemorrhage. Do not place an improvised tourniquet directly over a joint.

2. Expose the wound.

3. Place the prepared cravat and windlass 2-3 inches above the wound and secure the cravat tightly against the extremity with a full non-slip knot.

**CAUTION:** A tourniquet should be applied tight enough to block arterial flow.

4. Twist the windlass until the bleeding stops.

5. While holding tension on the windlass, place the windless inside the half knot of the second cravat proximal to the tourniquet (if possible).

6. Tighten the second cravat around the windless and secure the second cravat to the extremity with a full non-slip knot.

7. Assess for absence of a distal pulse.

**NOTE:** Checking for a distal pulse is not indicated for amputations.

**CAUTION:** In preparation for transport, ensure the improvised tourniquet is in open view at all times for monitoring purposes.

8. Place a "T" and the time of application on the casualty's forehead.

9. Secure the tourniquet in place with tape.

10. Reassess that bleeding is controlled.

11. Record the treatment on the FMC.

12. Evacuate the casualty.

**Evaluation Preparation:** None.

<b>Performance Measures</b>	GO	NO GO
1 Took BSI precautions.	_____	_____
2 Exposed the wound.	_____	_____
3 Placed the prepared cravat and windlass 2-3 inches above the wound and secured the cravat tightly against the extremity with a full non-slip knot.	_____	_____
4 Twisted the windlass until the bleeding stopped.	_____	_____
5 Placed the windlass inside the half knot of the second cravat while holding tension on the windlass, (if possible).	_____	_____
6 Tightened second cravat around windlass and secured cravat to the extremity with a full non-slip knot.	_____	_____
7 Assessed for absence of a distal pulse.	_____	_____
8 Placed a "T" and the time of application on the casualty's forehead.	_____	_____
9 Secured the tourniquet in place with tape.	_____	_____
10 Reassessed the injury to ensure bleeding was controlled.	_____	_____
11 Recorded the treatment on the FMC.	_____	_____
12 Evacuated the casualty.	_____	_____
13 Caused no further injury to the casualty.	_____	_____

**Evaluation Guidance:** Score each Soldier according to the performance measures in evaluation guide. Unless otherwise stated in the task summary, the Soldier must pass all performance measures to be scored GO. If the Soldier fails any step, show what was done wrong and how to do it correctly.

**References**

**Required**  
DD Form 1380

**Related**  
None

## Apply a Hemostatic Dressing

081-833-0211

**Conditions:** You have encountered a casualty who is bleeding externally. The wound is either not amenable to a tourniquet or a tourniquet is in place and alternate means of hemorrhage control are necessary. You will need a roll of combat gauze, cotton gauze (either wad or rolled) emergency bandage or elastic bandage, 3 inch tape, pen and DD Form 1380 US Field Medical Card (FMC). You have taken body substance isolation precautions and are not in a CBRN environment.

**Standards:** Apply a hemostatic dressing to control bleeding without causing further harm the casualty.

### Performance Steps

1. Remove all clothing or equipment to obtain access to the wound.
2. Identify the point of bleeding within the wound.
  - a. Remove any pooled blood from the wound cavity with your hand or a wad of cotton gauze.
  - b. Locate the bleeding vessel(s).
3. Pack combat gauze directly over the source of bleeding.
4. Pack the wound with the entire dressing. More than one combat gauze may be required.
5. Apply direct pressure for 3 minutes.
  - a. Periodically check the dressing to ensure proper placement and bleeding control.
  - b. If the bandage becomes completely soaked through and there is still active bleeding, pack a second combat gauze into the wound.
6. Bandage wound to secure the dressing in place.
  - a. If the wound cavity is deep, apply cotton gauze (either wad or rolled) over the dressing.
  - b. Secure dressing in place with either an emergency bandage or an elastic bandage.
7. Secure the bandage in place with tape.
8. Document treatment on the FMC.

### Evaluation Preparation:

Setup: For training and evaluation, have another Soldier act as the casualty. Have a roll of combat gauze, cotton gauze (wad or rolled), an emergency bandage or elastic bandage, and tape. Tell the casualty not to assist the Soldier in any way. The bleeding may be from the extremity (upper or lower), axillary area, inguinal area or neck. Use a training package of combat gauze.

Brief Soldier: Tell the Soldier the bleeding is bright red and spurting. The wound is not amenable to a tourniquet or a tourniquet is in place and alternate means of hemorrhage control is necessary; a hemostatic dressing is available. Tell the Soldier that they are not in a CBRN environment and to control the bleeding from the casualty's wound using the hemostatic dressing.

**Performance Measures**

	GO	NO GO
1 Removed all clothing or equipment to obtain access to the wound.	_____	_____
2 Identified the point of bleeding within the wound.	_____	_____
3 Packed combat gauze directly over the source of bleeding.	_____	_____
4 Packed the wound with the entire dressing.	_____	_____
5 Applied direct pressure for 3 minutes.	_____	_____
6 Bandaged wound to secure the dressing in place.	_____	_____
7 Secured the bandage in place with tape.	_____	_____
8 Documented treatment on the FMC.	_____	_____

**Evaluation Guidance:** Score each Soldier according to the performance measures in the evaluation guide. Unless otherwise stated in the task summary, the Soldier must pass all performance measures to be scored GO. If the Soldier fails any step, show what was done wrong and how to do it correctly.

**References**

**Required**  
DD Form 1380

**Related**  
None

## **Apply a Pressure Dressing to an Open Wound**

**081-833-0212**

**CAUTION:** All body fluids should be considered potentially infectious. Always observe body substance isolation (BSI) precautions by wearing gloves and eye protection as a minimal standard of protection.

**Conditions:** You have encountered a casualty who is bleeding externally from an open wound. All other more serious injuries have been assessed and treated. You will need the casualty's emergency bandage, bandage scissors, and a DD Form 1380 US Field Medical Card (FMC). You are not in a CBRN environment.

**Standards:** Apply a pressure dressing to control the bleeding without causing further harm to the casualty.

### **Performance Steps**

1. Fully expose the injury unless clothing is adhered to the wound.
2. Maintain direct (manual) pressure to limit the blood loss.
3. Apply the pressure dressing (casualty's emergency bandage).
  - a. Open the plastic dressing package.
  - b. Apply the dressing, white (sterile, non-adherent pad) side down, directly over the wound.
  - c. Wrap the elastic tail (bandage) around the extremity and run the tail through the plastic pressure bar.
  - d. Reverse the tail while applying pressure and continue to wrap the remainder of the tail around the extremity, continuing to apply pressure directly over the wound.
  - e. Secure the plastic closure bar to the last turn of the wrap.

**WARNING:** The emergency bandage must be loosened if the skin distal to the injury becomes cool, blue, numb, or pulseless.

f. Check the emergency bandage to make sure that it is applied firmly enough to prevent slipping without causing a tourniquet-like effect.

4. Reassess the wound to ensure bleeding has been controlled and initiate treatment for hypovolemic shock, if necessary. (See task 081-833-0047.)

5. Record the treatment on the FMC.

6. Evacuate the casualty.

### **Evaluation Preparation:**

**Setup:** For training and evaluation, have another Soldier act as the casualty. Use moulage on the casualty's arm or leg to simulate the wound. Have an emergency bandage present. After the emergency bandage has been applied, tell the Soldier the bleeding has not been controlled. Once manual pressure and elevation have been applied, tell the Soldier the bleeding is now controlled. Tell the casualty not to assist the Soldier in any way.

**Brief Soldier:** Tell the Soldier that they are not in a CBRN environment and to control the bleeding from a casualty's extremity.

<b>Performance Measures</b>	GO	NO GO
1 Exposed the wound.	_____	_____
2 Maintained direct (manual) pressure to limit the blood loss.	_____	_____
3 Applied a pressure dressing (emergency bandage).	_____	_____
4 Reassessed the wound to ensure bleeding is controlled and initiated treatment for hypovolemic shock, if necessary.	_____	_____
5 Recorded the treatment on the FMC.	_____	_____
6 Evacuated the casualty.	_____	_____
7 Caused no further injury to the casualty.	_____	_____

**Evaluation Guidance:** Score each Soldier according to the performance measures in the evaluation guide. Unless otherwise stated in the task summary, the Soldier must pass all performance measures to be scored GO. If the Soldier fails any step, show what was done wrong and how to do it correctly.

**References**

**Required**  
DD Form 1380

**Related**  
None

## Perform a Combat Casualty Assessment

**081-833-0067**

**Conditions:** You encounter a combat casualty under tactical conditions. You will need a combat medic aidbag, weapon, ballistic helmet, individual body armor, pen, an individual first aid kit (IFAK), four-sided occlusive dressing, 14 gauge 3 1/4 inch catheter-over-needle, 18 gauge 1 1/4 inch intravenous (IV) needle, a saline lock, and a DD Form 1380 US Field Medical Card (FMC). You are not in a CBRN environment.

**Standards:** Perform a combat casualty assessment to stabilize and prevent additional injuries to the casualty without endangering the mission.

### Performance Steps

1. Perform care under fire.

*NOTE:* Care under fire is care rendered at the scene of the injury while the combat medic and the casualty are still under effective hostile fire.

- a. Return fire as directed before providing medical treatment. This may include wounded Soldiers still able to fight.
  - b. Provide care to casualty tactically.
    - (1) Suppress enemy fire.
    - (2) Use cover or concealment (smoke).
    - (3) If casualty is unresponsive, move casualty and his equipment to cover as the tactical situation permits.
    - (4) Direct casualty to return fire, move to cover, and administer self-aid, (stop bleeding) if possible. If unable to move casualty to cover and still under direct enemy fire, tell the casualty not to move.
    - (5) Keep the casualty from sustaining additional wounds.
    - (6) Reassure the casualty.
  - c. Administer only life-saving care while still under enemy fire.
    - (1) Identify and control life-threatening hemorrhage with a tourniquet.
    - (2) Cervical spine control is not necessary.

*NOTE:* The combat medic rendering care decides treatment on the basis of the relative risk of further injury versus that of exsanguination.

- d. Communicate medical situation to team leader.
- e. Tactically transport casualty, his weapon, and mission-essential equipment to cover.
- f. Recheck bleeding control measures as the tactical situation permits.
2. Perform tactical field care.

*NOTE:* Tactical field care is care rendered by the medic when no longer under effective hostile fire. Tactical field care also applies to situations in which an injury has occurred on a mission but there has been no hostile fire. Available medical equipment is limited to that carried into the field by the combat medic and mission personnel.

- a. In the following situations, communicate medical situation to patrol leader.
  - (1) Upon determining that casualty will not be able to continue mission.

(2) Before initiating any medical procedures (ensure tactical situation allows for time required).

(3) Upon any significant change in casualty's status.

b. Note general impression of the casualty by determining responsiveness or level of consciousness (AVPU).

(1) A - Alert.

(2) V - Responds to verbal commands.

(3) P - Responds to painful stimuli.

(4) U - Unresponsive.

*NOTE:* If the casualty has suffered from a blast or penetrating trauma and has no signs of life (no pulse, no blood pressure, no respirations), do not perform CPR. These casualties will not survive and you may expose yourself to enemy fire and delay care to other casualties.

c. Assess and secure the airway.

(1) If the casualty is conscious and not in respiratory distress, do not administer airway intervention.

(2) If the casualty is unconscious, use a chin-lift or jaw-thrust to open the airway. Use a nasopharyngeal airway (NPA) to maintain the airway.

(3) Roll the casualty into the recovery position. This allows for accumulated blood and mucus to drain and not choke the casualty.

(4) For an unconscious casualty with an obstructed airway or severe maxillofacial trauma, perform a surgical cricothyroidotomy. (See task 081-833-3005.)

d. Assess the chest and perform medical care to correct problems in breathing or respiration.

(1) Immediately seal any penetrating injuries to the chest with a four-sided occlusive dressing, or apply a commercial device such as the Asherman®, Hyphen®, or Bolin® Chest Seals.

(2) Monitor casualty for progressive severe respiratory distress (breathing becomes more labored and faster).

(3) If respiration becomes progressively worse, consider this a tension pneumothorax and decompress affected chest side with a 14 gauge 3-1/4 inch catheter-over-needle inserted at second intercostal space (ICS) at midclavicular line (MCL). Secure the catheter in place with tape.

e. Identify and control major bleeding not previously controlled.

(1) Apply direct pressure and/or an emergency trauma bandage, as appropriate.

(2) If a tourniquet was previously applied, consider changing the tourniquet to a pressure dressing and/or using a hemostatic bandage to control bleeding.

(3) Leave the tourniquet in place while doing this. Loosen it, but do not remove it.

(4) If the wound continues to bleed, retighten the tourniquet until bleeding stops.

f. Determine if the casualty requires fluid resuscitation.

(1) A palpable radial pulse and normal mental status should be used to determine who needs fluid resuscitation. These can be determined in the typical noisy and chaotic battlefield



environment. Blood pressure measurement is not necessary. If a casualty has a radial pulse, his equivalent blood pressure is at least 80 mmHg.

(2) If the casualty has a superficial wound, IV resuscitation is not necessary but oral fluid hydration should be encouraged.

(3) If the casualty has a significant wound, either extremity or truncal (neck, chest, abdomen, or pelvis), and the casualty is coherent and has a palpable radial pulse:

(a) Start an 18 gauge IV catheter and place a saline lock. Hold fluids but reevaluate as frequently as the tactical situation allows. If unable to start a peripheral IV, consider starting a F.A.S.T. 1 sternal intraosseous line. (See task 081-833-0185.)

(b) Upper extremity is first choice. Do not start an IV on an extremity distal to a significant wound.

(c) If the casualty does not have a radial pulse, ensure that the bleeding has stopped using whatever means available--direct pressure, pressure dressings, hemostatic bandage, or tourniquets as needed.

(d) Once the bleeding has stopped, give 500 ml of Hextend® as rapidly as possible. Recheck in 30 minutes. If the radial pulse has returned, do not give any additional fluids but monitor as frequently as possible.

(e) If the radial pulse does not return, give an additional 500 ml of Hextend®.

(f) Recheck in 30 minutes. If the radial pulse returns, hold additional fluids and evacuate ASAP. If the radial pulse does not return, then triage your supplies and equipment to other casualties.

g. Expose any wounds.

(1) Remove the minimum amount of clothing required to expose and treat injuries. Dress the wounds to prevent contamination and help with hemostasis. An emergency bandage is ideal for this. Search for exit wounds.

(2) Always check for exit wounds.

(3) Protect the casualty against the environment.

h. Splint obvious fractures. (See task 081-833-0263.)

i. Administer pain medications as needed to any Soldier wounded in combat.

(1) If the casualty is still able to fight, Mobic® 15 mg po qd with two 650 mg caplets of acetaminophen every 8 hours, will control mild to moderate pain and not cause drowsiness. These medications and an antibiotic make up the "Combat Pill Pack", and should be issued to each Soldier prior to deployment.

(2) If the casualty is unable to fight--

(a) Morphine 5 mg given IV (through the saline lock) and repeated every 10 minutes as necessary is very effective in controlling severe pain. If a saline lock is used, it should be flushed with 5 ml of saline after the morphine administration.

(b) Phenergan 25 mg IV or IM may be necessary to combat the nausea and vomiting associated with morphine.

*NOTE:* Medics who carry morphine must be familiar with its side effects and trained in the use of Naloxone to counter these side effects.

(c) Pain relief can also be attained with the use of fentanyl transmucosal lozenges. These lozenges are placed between the cheek and gum and will be absorbed through the oral mucosa. This method allows for narcotic pain control without IV access.

(d) Ensure there is visible evidence of the amount and time of pain medication given.

(3) Soldiers should avoid aspirin and some of the older anti-inflammatory medications because of their detrimental effects on blood clotting.

(4) Antibiotics should be considered in all Soldiers wounded in combat who have a 3 hour delay in evacuation time since these wounds are prone to infection.

(a) In Soldiers who are awake and alert, give an oral antibiotic.

(b) In unconscious Soldiers or those who may not be able to take an oral antibiotic, IV antibiotics may be given through the saline lock every 12 hours.

*NOTE:* Soldiers who may have allergies to these medications must be identified in the pre-deployment planning phase and alternate medications provided.

j. Initiate medical evacuation request lines 1 through 5 (lines 6 through 9, as appropriate).

k. Complete FMC.

l. Transport the casualty to the site where evacuation is anticipated.

3. Perform combat casualty evacuation care (CASEVAC). Care in the CASEVAC phase does not differ significantly from the tactical field care phase. However, there are two significant differences.

a. Additional medical personnel may accompany the evacuation asset to assist the medic.

b. Additional medical supplies and equipment may also accompany the evacuation asset.

This equip may consist of:

(1) Oxygen.

(2) Electronic monitoring devices.

(3) Additional IV fluids.

(4) Blood (may be available)

**Evaluation Preparation:**

Setup: Give the Soldier a simulated casualty and a scenario in which he must perform a combat casualty assessment.

Brief Soldier: Tell the Soldier to perform a combat casualty assessment.

**Performance Measures**

	GO	NO GO
1 Performed care under fire.	_____	_____
2 Performed tactical field care.	_____	_____
3 Performed combat casualty evacuation care.	_____	_____

**Evaluation Guidance:** Score each Soldier according to the performance measures. Unless otherwise stated in the task summary, the Soldier must pass all performance measures to be scored GO. If the Soldier fails any steps, show what was done wrong and how to do it correctly.

**References**

**Required**  
DD Form 1380

**Related**  
None

## Apply a Cervical Collar

081-833-0177

**CAUTION:** All body fluids should be considered potentially infectious. Always observe body substance isolation (BSI) precautions by wearing gloves and eye protection as a minimal standard of protection.

**Conditions:** A casualty has received traumatic injuries and now complains of neck pain. All immediate life threats have been assessed and treated. Another Soldier is available to assist you. You will need a rigid cervical collar device and head supports. You are not in a CBRN environment.

**Standards:** Complete all the steps necessary to apply a cervical collar to a casualty with a suspected cervical spine injury without causing additional injury to the casualty.

### Performance Steps

1. While your assistant is stabilizing the casualty's cervical spine, complete an initial assessment and care for all life-threatening injuries before applying the cervical collar.

**WARNING:** If you suspect the casualty has a spinal injury, treat him as though he has a spinal injury.

2. Use the mechanism of injury, level of responsiveness, and location of injuries to determine the need for cervical immobilization.

3. While maintaining manual cervical spine stabilization and neutral neck alignment, assess the casualty's neck prior to placing the collar. Once the collar is in place, you will not be able to assess or palpate the back of the neck.

4. Reassure the casualty and explain the procedure to him.

5. Determine the size of collar to apply.

a. The front height of the collar should fit between the point of the chin and the chest at the suprasternal notch.

b. Once in place, the collar should rest on the shoulder girdle and provide firm support under both sides of the mandible without obstructing the airway or any ventilation efforts.

c. If the collar is too large, the casualty's neck may be placed in hyperextension.

d. If the collar is too small, the casualty's neck may be placed in hyperflexion.

6. Apply the collar to a seated casualty, if applicable.

a. Have the other Soldier apply in-line stabilization of the head and neck from behind the casualty.

b. Place the chin support first.

c. Wrap the collar around the neck.

d. Secure the Velcro® strap in place.

e. Maintain manual stabilization of the head and neck until the casualty is immobilized on a long spine board.

**NOTE:** Cervical collars do not fully immobilize the cervical spine; therefore, you must maintain manual stabilization of the casualty's neck until the casualty is fully immobilized on a long spine board. (See task 081-833-0181.)

7. Apply the collar to a supine casualty, if applicable.

a. Have the other Soldier kneel at the casualty's head and manually apply in-line stabilization of the head and neck.

b. Set the collar in place around the neck.

c. Secure the Velcro strap in place.

d. Maintain manual stabilization of the head and neck until the casualty is immobilized on a long spine board.

**Evaluation Preparation:**

Setup: For training and evaluation, have another Soldier act as the casualty. You will need another Soldier to act as an assistant. The Soldier being tested is to act as the team leader and direct the actions of the assistant. The casualty may be placed in a vehicle or other scenario, depending on the available resources and the technique you are testing. Tell the casualty not to assist the Soldiers in any way. Tell the assisting Soldier to only perform those actions the Soldier being evaluated directs.

Brief Soldier: Tell the Soldier to state the signs and symptoms of a spinal injury. Tell the Soldier that the casualty has a suspected cervical injury. Then tell the Soldier to apply a cervical collar and to direct the actions of the assistant.

<b>Performance Measures</b>	GO	NO GO
1 Completed the initial assessment.	_____	_____
2 Used the mechanism of injury, level of responsiveness, and location of injuries to determine the need for cervical immobilization.	_____	_____
3 Maintained manual stabilization and assessed the casualty's neck prior to placing the collar.	_____	_____
4 Reassured the casualty.	_____	_____
5 Determined the size of collar to apply.	_____	_____
6 Applied the collar to a seated casualty, if applicable.	_____	_____
7 Applied the collar to a supine casualty, if applicable.	_____	_____

**Evaluation Guidance:** Score each Soldier according to the performance measures. Unless otherwise stated in the task summary, the Soldier must pass all performance measures to be scored GO. If the Soldier fails any step, show what was done wrong and how to do it correctly.

**References**

**Required**  
None

**Related**  
None

## Apply a Long Spine Board

081-833-0181

**Conditions:** You have determined that your casualty needs a long spine board. All immediate life threats have been treated. Three or four Soldiers are available for assistance. You will need straps, cravats, towels, long spine boards, safety pins, materials to improvise a cervical collar and head supports, and DD Form 1380 US Field Medical Card (FMC). You are not in a CBRN environment.

**Standards:** Complete all the steps necessary to immobilize and transport a casualty with a suspected spine injury on a long spine board, without causing additional injury to the casualty.

### Performance Steps

**WARNING:** If you suspect that the casualty has a spinal injury, treat him as though he does have a spinal injury.

1. Check for the signs and symptoms of a spinal injury.

a. Spinal deformity. Its presence indicates a severe spinal injury, but its absence does not rule one out.

b. Tenderness and/or pain in the spinal region.

(1) Detect it by palpation or ask the casualty.

(2) The presence of any pain is sufficient cause to suspect the presence of a spinal injury.

c. Lacerations and/or contusions in the spinal region indicate severe trauma and usually accompany a spinal injury.

*NOTE:* The absence of lacerations and/or contusions does not rule out a spinal injury.

d. Weakness, loss of sensation, and/or paralysis.

(1) A neck level (cervical) spine injury may cause numbness or paralysis in all four extremities.

(2) A waist level spinal injury may cause numbness or paralysis below the waist.

(3) Ask the casualty to try to move the fingers and toes to check for paralysis.

2. Place the casualty on a long spine board.

*NOTE:* If a spine board is not available, utilize a standard litter or improvised litter made from a board or door. A hard surface is preferable to one that gives with the casualty's weight.

a. The log roll technique.

(1) Place the spine board next to, and parallel with, the casualty.

(2) Immobilize the casualty's head and neck using manual stabilization.

(a) Place your hands on both sides of the casualty's head, cradling the skull with your hands.

(b) Maintain manual stabilization until the casualty has been secured on the spine board.

(3) Apply a cervical collar, if available, or improvise one. (See task 081-833-0177.)

(4) Brief each of the three assistants on their duties and instruct them to kneel on the same side of the casualty, with the spine board on the opposite side of the casualty.

(a) First assistant. Place the near hand on the shoulder and the far hand on the waist.

(b) Second assistant. Place the near hand on the hip and the far hand on the thigh.

(c) Third assistant. Place the near hand on the knee and the far hand on the ankle.

(5) On your command, and in unison, the assistants roll the casualty slightly toward them. Turn the casualty's head, keeping it in a straight line with the spine.

(6) Instruct the assistants to reach across the casualty with one hand, grasp the spine board at its closest edge, and slide it against the casualty. Instruct the second assistant to reach across the board to the far edge and hold it in place to prevent board movement.

(7) Instruct the assistants to slowly roll the casualty back onto the board. Keep the head and spine in a straight line.

(8) Place the casualty's wrists together at the waist and tie them together loosely.

*NOTE:* If the cervical collar or improvised collar does not fit flush with the spine board, place a roll in the hollow space between the neck and board. The roll should only be large enough to fill the gap, not to exert pressure on the neck.

b. The straddle-slide technique.

*NOTE:* Use this method when limited space makes it impossible to use the log roll technique (such as fractured pelvis).

(1) Stand at the head of the casualty with your feet wide apart.

(2) Apply stabilization to the casualty's head and apply a cervical collar.

(3) Instruct the first assistant to stand behind you (facing your back), to line up the spine board, and to gently push the spine board under the casualty at your command.

(4) Instruct the second assistant to straddle the casualty while facing you and gently elevate the shoulders so that the spine board can be slid under them.

(5) Instruct the third assistant (facing you) to carefully elevate the hips while the spine board is being slid under the casualty.

**WARNING:** Complete all movements simultaneously, keeping the head and spine in a straight line.

*NOTE:* If the cervical collar or improvised collar does not fit flush with the spine board, place a roll in the hollow space between the neck and board. The roll should only be large enough to fill the gap, not to exert pressure on the neck.

(6) Instruct the fourth assistant (facing you) to carefully elevate the legs and ankles while the board is being slid into place under the casualty.

3. Secure the casualty to the long spine board.

a. Secure the casualty's torso and lower extremities with straps across the chest, hips, thighs, and lower legs.

*NOTE:* Include the arms if the straps are long enough. If the spine board is not provided with straps and fasteners, use cravats or other long strips of cloth.

**WARNING:** Do not release manual stabilization until the cravats or head straps are firmly in place.

- b. Secure the casualty's head and head supports to the board with straps or cravats.
  - (1) Apply head supports.
  - (2) Use two rolled towels, blankets, boots, or similar material. (Do not use sandbags.)
  - (3) Place one close to each side of the head.
  - (4) Using a cravat-like material across the forehead, make the supports and head one unit by tying to the board.
- 4. Record the treatment on the FMC.
- 5. Evacuate the casualty.
- 6. Do not cause further injury to the casualty.

**Evaluation Preparation:**

Setup: For training and evaluation, have another Soldier act as the casualty. You will need three or four Soldiers to act as the assistants. The Soldier being tested is to act as the team leader and direct the actions of the assistants. The casualty may be placed in a vehicle or other scenario, depending on available resources and the technique you are testing. Tell the casualty not to assist the Soldiers in any way.

Brief Soldier: To test step 1, tell the Soldier to state the signs and symptoms of a spinal injury. Tell the Soldier that the casualty has a suspected spinal injury. Then tell the Soldier to position the casualty on a spine board and to direct the actions of the assistants.

<b>Performance Measures</b>	GO	NO GO
1 Checked for signs and symptoms of a spinal injury.	_____	_____
2 Placed the casualty on the long spine board.	_____	_____
3 Secured the casualty on the long spine board.	_____	_____
4 Recorded the treatment on the FMC.	_____	_____
5 Evacuated the casualty.	_____	_____
6 Did not cause further injury to the casualty.	_____	_____

**Evaluation Guidance:** Score each Soldier according to the performance measures in the evaluation guide. Unless otherwise stated in the task summary, the Soldier must pass all performance measures to be scored GO. If the Soldier fails any step, show what was done wrong and how to do it correctly.

**References**

**Required**  
DD Form 1380

**Related**  
None

## Subject Area 4: Airway Management

### Set Up an Oxygen Tank

081-833-0098

**CAUTION:** All body fluids should be considered potentially infectious. Always observe body substance isolation (BSI) precautions by wearing gloves and eye protection as a minimal standard of protection.

**Conditions:** You need to set up an oxygen tank. You have already performed a patient care handwash. You will need a full oxygen cylinder with a regulator/flow meter, non-sparking cylinder wrench, oxygen regulator/flow meter for D cylinders, yoke attachment, humidifier, sterile water, oxygen cylinder transport carrier and/or stand oxygen, oxygen administration device, and warning signs. You are not in a CBRN environment.

**Standards:** Set up the oxygen tank without violating safety precautions or endangering patients or yourself.

**NOTE:** Most of pre-hospital care, oxygen is given with a D sized oxygen cylinder. This task is written for a D sized oxygen cylinder.

#### Performance Steps

1. Obtain the necessary equipment.

**CAUTION:** Always ensure that the cylinder selected contains oxygen and not some other compressed gas. United States oxygen cylinders are color coded green, silver or chrome with a green area around the valve stem on top. The international code is white.

- a. Oxygen cylinder. (See Figure 3-2.)

**NOTE:** Check the oxygen cylinder tag to determine whether the tank is "FULL", "IN USE" (partially full), or "EMPTY". (See Figure 3-2a.)

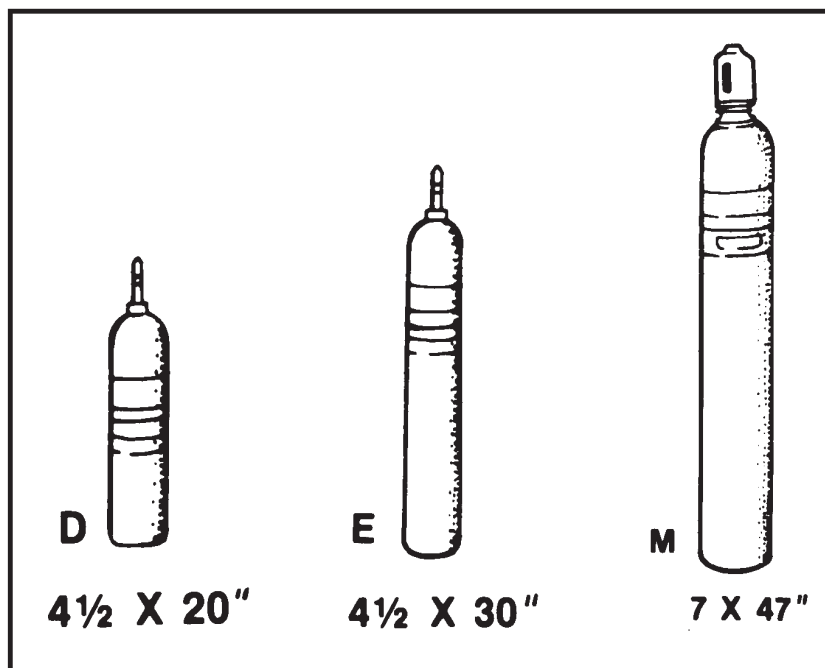

Figure 3-2 . Oxygen cylinder



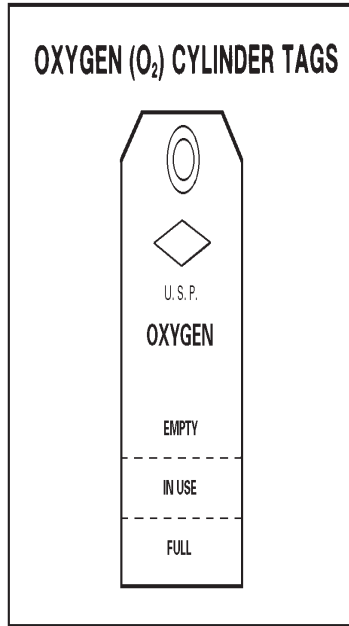

Figure 3-2a. Oxygen cylinder tag

b. Cylinder with regulator/flowmeter. (See Figure 3-3.)

**NOTE:** When the cylinder regulator pressure gauge reads 200 psi or lower, the oxygen tank is considered empty.

The pressure-compensated flowmeter is affected by gravity and must be maintained in an upright position. The Bourdon gauge flowmeter is not affected by gravity and can be used in any position.

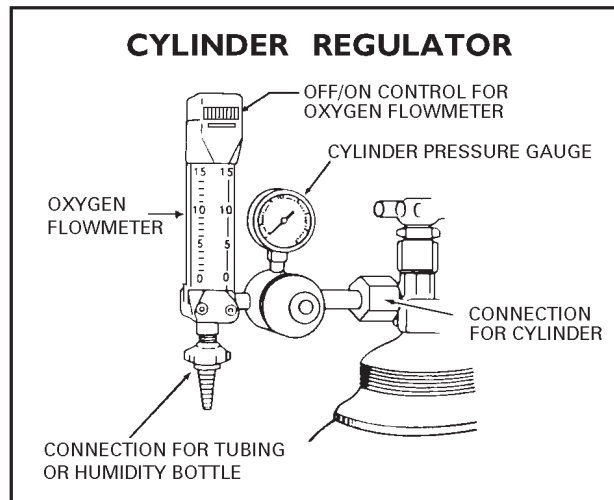

Figure 3-3. Cylinder with regulator

- c. Humidifier.
- d. Sterile water.
- e. Non-sparking cylinder wrench.
- f. Oxygen cylinder transport carrier and/or stand.
- g. Oxygen administration device appropriate for the patient or as ordered by the medical officer (nasal cannula, non-rebreather mask, or BVM device with reservoir).
- h. Warning signs.
  - (1) "NO SMOKING".

**CAUTION:** Because of the extreme pressure in oxygen tanks, they should be handled with great care. Do not allow tanks to be banged together, dropped, or knocked over.

- (2) "OXYGEN IN USE".
2. Secure the oxygen cylinder.
    - a. Upright position or IAW local SOP.
    - b. Secured with straps or in a stand.
    - c. Away from doors and areas of high traffic.

3. Remove the cylinder valve cap.

**NOTE:** The cylinder valve cap may be noisy or difficult to remove; however, the threads of the cylinder cap should never be oiled.

4. Use either the hand wheel or a non-sparking wrench to "crack" (slowly open and quickly close) the cylinder to flush out any debris.

5. Attach the regulator/flowmeter to the cylinder.

- a. Locate the three holes on the oxygen cylinder stem and ensure that an "O" ring is present. (See Figure 3-4.)

**NOTE:** If the "O" ring is not present, an oxygen leak will occur.

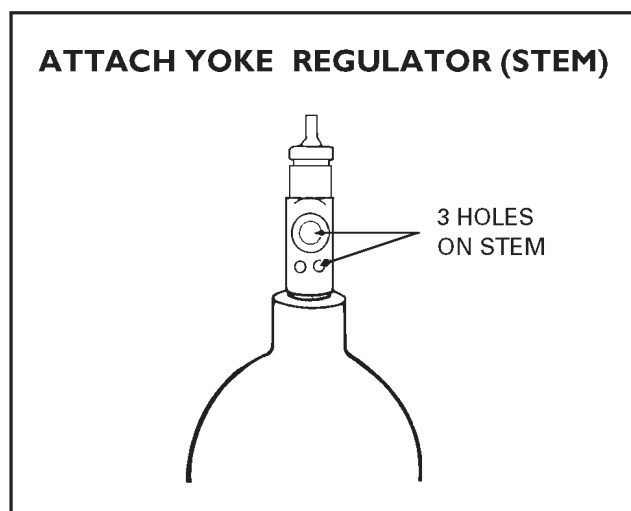

Figure 3-4. York regulator (stem)

b. Examine the yoke attachment and locate the three corresponding pins on the yoke attachment. (See Figure 3-5.)

*NOTE:* The compressed gas industry uses a "pin-indexing system" for portable gas cylinders. The locations of the pins on the yoke match only the regulator/flowmeter for an oxygen cylinder.

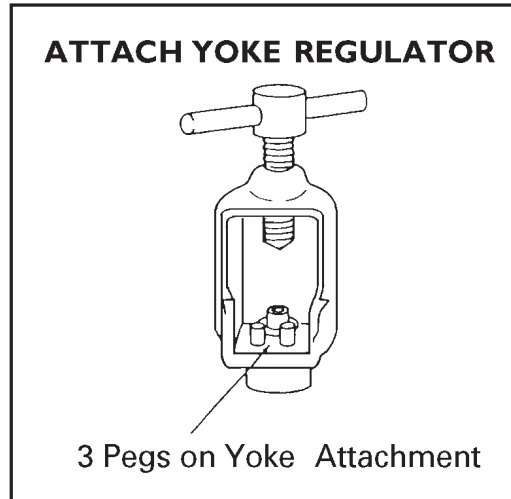

Figure 3-5. Yoke Regulator

c. Slide the yoke attachment over the cylinder stem, ensuring that the pins are seated in the proper holes.

d. Turn the vise-like screw on the side of the yoke attachment to secure it.

e. Open the valve to test for leaks, and then close it.

*NOTE:* If there is a leak, check the regulator connection and obtain a new regulator/flowmeter and/or cylinder, if necessary. When in-wall oxygen is available, it will be attached to the oxygen outlet as follows: a. Turn the flow adjusting valve of the flowmeter to the OFF position. b. Insert the flowmeter adapter into the opening outlet and press until a firm connection is made.

6. Fill the humidifier bottle to the level indicated (about two-thirds full) with sterile water.

7. Attach the humidifier to the flowmeter.

*NOTE:* If an oxygen tube connector adapter is present, remove it from the flowmeter by turning the wing nut.

a. Attach the humidifier to the flowmeter with the wing nut on the humidifier.

*NOTE:* Not all humidifiers have "wing" style nuts. Some have regular "bolt" style nuts.

b. Secure the nut by hand-tightening it.

*NOTE:* Humidifiers and tubing should be changed at least once every 24 hours (or more often IAW local SOP).

**CAUTION:** "OXYGEN" and "NO SMOKING" signs should be posted in the areas where oxygen is in use or stored.

8. Post warning signs.

9. Report and/or record completion of the procedure.

**Evaluation Preparation:**

Setup: Place all necessary materials and equipment including a full oxygen cylinder, non-sparking cylinder wrench, appropriate oxygen regulator/flow meter for designated oxygen cylinder, yoke attachment, humidifier, sterile water, oxygen administration devices, and warning signs. Create a trauma or non trauma scenario that will dictate which oxygen administration device should be applied.

Brief Soldier: Tell the Soldier to assemble the oxygen system to include appropriate oxygen administration device.

<b>Performance Measures</b>	GO	NO GO
1 Obtained the necessary equipment.	_____	_____
2 Secured the oxygen cylinder.	_____	_____
3 Removed the cylinder valve cap.	_____	_____
4 Used either the hand wheel or a non-sparking wrench to "crack" (slowly open and quickly close) the cylinder to flush out any debris.	_____	_____
5 Attached the regulator/flowmeter to the cylinder.	_____	_____
6 Filled the humidifier bottle to the level indicated (about two-thirds full) with sterile water.	_____	_____
7 Attached the humidifier to the flowmeter.	_____	_____
8 Posted warning signs.	_____	_____
9 Reported and/or recorded completion of the procedure.	_____	_____

**Evaluation Guidance:** Score each Soldier according to the performance measures. Unless otherwise stated in the task summary, the Soldier must pass all performance measures to be scored GO. If the Soldier fails any steps, show what was done wrong and how to do it correctly.

**References**

**Required**  
None

**Related**  
None

## Insert a Combitube®

**081-833-0169**

**Conditions:** An unconscious casualty requires the insertion of an esophageal tracheal Combitube®. An assistant is performing resuscitative measures. No cervical spine injury is present. You will need a Combitube®, 140 cc syringe, 10 cc syringe, gloves, eye protection, suction equipment, stethoscope, pulse oximeter, and bag-valve-mask (BVM). You are not in a CBRN environment.

**Standards:** Insert the Combitube® and successfully ventilate the casualty without causing further injury.

### Performance Steps

1. Take body substance isolation (BSI) precautions.
  2. Inspect upper airway for visible obstruction.
  3. Inspect and test equipment.
  4. Lubricate distal end of tube with a water-soluble lubricant.
  5. Direct assistant to pre oxygenate casualty.
  6. Perform a tongue-jaw lift.
  7. Insert device until casualty's teeth sit between printed black rings, within 3 attempts.
  8. Inflate #1 (blue) cuff with appropriate amount of air based on size of tube.
  9. Inflate #2 (white) cuff with appropriate amount of air based on size of tube.
  10. Direct assistant to ventilate casualty with a BVM through primary tube (generally marked #1).
  11. Perform steps 6-10 in less than 30 seconds.
  12. Watch for rise and fall of the chest, auscultate for breath sounds and over the epigastrium to confirm tube placement.
- NOTE:* If breath sounds are negative and gastric insufflations is positive, direct assistant to ventilate with the shortened tube (generally marked #2), the auscultate breath sounds and gastric sounds to affirm placement.
13. Assess casualty for spontaneous respirations. (For 10 seconds.)
  14. Attach pulse oximeter to casualty, if available.
  15. Assist when respirations are <8 or >30 or a pulse oximeter reading <90%.
  16. Secure device to the casualty around casualty's neck.

### Evaluation Preparation:

Setup: For training and evaluation, use a simulation device capable of receiving Combitube® placement.

Brief Soldier: Tell the Soldier that a casualty requires the insertion of a Combitube®.

<b>Performance Measures</b>	GO	NO GO
1 Took BSI precautions.	_____	_____
2 Inspected upper airway for visible obstruction.	_____	_____
3 Inspected and tested equipment.	_____	_____
4 Lubricated distal end of the tube.	_____	_____
5 Performed a tongue-jaw lift.	_____	_____
6 Directed assistant to pre-oxygenate the casualty.	_____	_____
7 Inserted device until casualty's teeth were between printed black rings, within 3 attempts.	_____	_____
8 Inflated #1 (blue) cuff with appropriate amount of air based on size of tube.	_____	_____
9 Inflated #2 (white) cuff with appropriate amount of air based on size of tube.	_____	_____
10 Directed assistant to ventilate casualty with a BVM through primary tube.	_____	_____
11 Performed steps 6-10 in less than 30 seconds.	_____	_____
12 Watched for rise and fall of the chest, auscultated for breath sounds and over the epigastrium to confirm tube placement.	_____	_____
13 Assessed casualty for spontaneous respirations. (For 10 seconds.)	_____	_____
14 Attached pulse oximeter to casualty, if available.	_____	_____
15 Assisted when respirations were <8 or >30 or a pulse oximeter reading <90%.	_____	_____
16 Secured device to the casualty around casualty's neck.	_____	_____

**Evaluation Guidance:** Score each Soldier according to the performance measures in the evaluation guide. Unless otherwise stated in the task summary, the Soldier must pass all performance measures to be scored GO. If the Soldier fails any step, show what was done wrong and how to do it correctly.

**References**

**Required**  
None

**Related**  
None

## Insert a Nasopharyngeal Airway

**081-833-0142**

**CAUTION:** All body fluids should be considered potentially infectious. Always observe body substance isolation (BSI) precautions by wearing gloves and eye protection as a minimal standard of protection.

**Conditions:** You encounter a casualty with a reduced level of consciousness who requires an airway adjunct. The casualty has a gag reflex with no evidence of head injury or head trauma. You will need disposable gloves (latex free), a nasopharyngeal airway (NPA), water-based lubricant and a DD Form 1380 US Field Medical Card (FMC). You have performed a patient care handwash, taken body substance isolation precautions and are not in a CBRN environment.

**Standards:** Insert a nasopharyngeal airway (NPA) without causing injury to the casualty.

### Performance Steps

**CAUTION:** Do not use the nasopharyngeal airway if there is clear fluid (cerebrospinal fluid-CSF) coming from the ears or nose. This may indicate a skull fracture.

1. Place the casualty supine with the head in a neutral position.
2. Select the appropriate size of airway using one of the following methods:
  - a. Measure the airway from the patient's nostril to the earlobe.
  - b. Measure the airway from the patient's nostril to the angle of the jaw.

*NOTE:* Choosing the proper length ensures appropriate diameter. Standard adults sizes are 34, 32, 30, and 28 French.

**CAUTION:** Do not use a petroleum-based or non-water-based lubricant. These substances can cause damage to the tissues lining the nasal cavity and pharynx thus increasing the risk for infection.

3. Lubricate the tube with a water-based lubricant.
4. Insert the airway.
  - a. Push the tip of the nose upward gently.
  - b. Position the tube so that the bevel of the airway faces toward the septum.

*NOTE:* Most nasopharyngeal airways are designed to be placed in the right nostril.

**CAUTION:** Never force the airway into the patient's nostril. If resistance is met, pull the tube out and attempt to insert it in the other nostril.

- c. Insert the airway into the nostril and advance it until the flange rests against the nostril.
5. Place the patient in the recovery (lateral recumbent, coma) position to prevent aspiration of blood, mucus, or vomitus.
6. Record the procedure on the FMC.

### Evaluation Preparation:

Setup: For training and evaluation, use a simulation device capable of accepting a nasopharyngeal airway device.

Brief Soldier: Tell the Soldier the simulated patient requires an NPA to be inserted.

**Performance Measures**

GO            NO GO

1	Positioned the casualty.	_____	_____
2	Measured and selected the appropriate size of airway.	_____	_____
3	Lubricated the nasal airway.	_____	_____
4	Fully inserted the airway	_____	_____
5	Placed the patient in the recovery position.	_____	_____
6	Recorded the procedure on the FMC.	_____	_____

**Evaluation Guidance:** Score each Soldier according to the performance measures in the evaluation guide. Unless otherwise stated in the task summary, the Soldier must pass all performance measures to be scored GO. If the Soldier fails any step, show what was done wrong and how to do it correctly.

**References**

**Required**  
DD Form 1380

**Related**  
None



## Perform Endotracheal Suctioning

**081-833-0170**

**Conditions:** You have a patient that requires endotracheal suctioning. You will need suction unit, suction catheter, sterile basin, sterile water, sterile gloves, or a disposable suction kit. You have performed a patient care handwash. You are not in a CBRN environment.

**Standards:** Perform endotracheal suctioning without violating aseptic technique or causing injury to the patient.

### Performance Steps

1. Explain the procedure to the patient.
2. Position the patient in the semi-Fowler's position.

*NOTE:* In some cases, such as spinal injuries, the patient will have to remain in whatever position he is in at the time.

**WARNING:** If the suction pressure is too low, the secretions cannot be removed. If the pressure is too high, the mucous membranes may be forcefully pulled into the catheter opening.

3. Check the pressure on the suction apparatus.

*NOTE:* Ensure that the pressure reading is within the limits specified by local SOP and the recommendations of the equipment manufacturer.

4. Prepare the sterile materials. (See task 081-833-0007.)

**CAUTION:** Monitor the pulse oximeter reading during the entire procedure. (See task 081-833-0164.)

5. Pre-oxygenate the patient.

*NOTE:* The goal of pre-oxygenation is to maintain pulse oximetry (SPO<sub>2</sub>) at or above 95%.

6. Put on sterile gloves. (See task 081-831-0008.)

7. Remove the catheter from the package using the dominant hand, keeping the catheter coiled to prevent contamination.

*NOTE:* This hand must remain sterile.

**CAUTION:** Do not touch the patient while measuring the length of the catheter. This will violate aseptic technique.

8. Measure the length of the suction catheter so that it will be approximately at the carina.
  - a. Tip of catheter to the ear.
  - b. From the ear to the nipple line.
9. Attach the tubing to the catheter with the non-dominant hand.

*NOTE:* This hand does not have to remain sterile.

10. Test the patency of the catheter.
  - a. Turn the suction unit on with the non-sterile hand.
  - b. Insert the catheter tip into the sterile saline solution using the sterile hand.
  - c. Place the non-sterile thumb over the suction port to create suction. Observe the saline entering the drainage bottle.

**NOTE:** If no saline enters the bottle, check the suction unit and/or replace the catheter and retest for patency.

11. Suction the patient.
  - a. Remove the oxygen delivery device with the non-dominant hand.
  - b. Lubricate the catheter tip by dipping it into the saline solution.
  - c. Gently insert the catheter into the airway to the measured length without suctioning.

**CAUTION:** Do not suction any longer than 15 seconds.

- d. Apply intermittent suction by placing and releasing the non-dominant hand over the vent of the catheter while withdrawing the catheter.
- e. Replace the oxygen delivery device and re-oxygenate the patient.
- f. Repeat steps 10a through 10e as necessary, allowing time for re-oxygenation to take place between procedures.

**WARNING:** Discontinue suctioning immediately if changes in color or pulse rate occur.

12. Observe the patient for hypoxemia.
13. Disconnect the catheter and remove the gloves.

**NOTE:** Discard items IAW local SOP.

14. Make the patient comfortable.
15. Discard, or clean and store, used items IAW local SOP.
16. Record the procedure on the appropriate form.
  - a. Respirations (rate and breath sounds before and after suctioning).
  - b. Type, amount and color of secretions.
  - c. Patient's toleration of the procedure.

**Evaluation Preparation:**

Setup: For training and evaluation, use a mannequin to be the simulated patient.

Brief Soldier: Tell the Soldier the simulated patient requires endotracheal suctioning. Have the testing Soldier verbalize the steps while performing endotracheal suctioning.

<b>Performance Measures</b>	GO	NO GO
1 Explained the procedure to the patient.	_____	_____
2 Positioned the patient in the semi-Fowler's position.	_____	_____
3 Checked the pressure on the suction apparatus.	_____	_____
4 Prepared the sterile materials.	_____	_____
5 Pre-oxygenated the patient.	_____	_____
6 Put on sterile gloves.	_____	_____
7 Removed the catheter from the package using the dominant hand, keeping the catheter coiled to prevent contamination.	_____	_____

<b>Performance Measures</b>	GO	NO GO
8 Measured the length of the suction catheter so that it will be approximately at the carina.	_____	_____
9 Attached the tubing to the catheter with the non-dominant hand.	_____	_____
10 Tested the patency of the catheter.	_____	_____
11 Suctioned the patient.	_____	_____
12 Observed the patient for hypoxemia.	_____	_____
13 Disconnected the catheter and removed the gloves.	_____	_____
14 Made the patient comfortable.	_____	_____
15 Discarded, or cleaned and stored, used items IAW local SOP.	_____	_____
16 Recorded the procedure on the appropriate form.	_____	_____

**Evaluation Guidance:** Score each Soldier according to the performance measures. Unless otherwise stated in the task summary, the Soldier must pass all performance measures to be scored GO. If the Soldier fails any steps, show what was done wrong and how to do it correctly.

**References**

**Required**  
None

**Related**  
None

## Open the Airway

081-831-0018

**CAUTION:** All body fluids should be considered potentially infectious. Always observe body substance isolation (BSI) precautions by wearing gloves and eye protection as a minimal standard of protection.

**Conditions:** You have an unresponsive and apneic casualty with a palpable central pulse. You will need a pen and SF 600 (Medical Record-Chronological Record of Medical Care). You have performed a patient care hand wash, taken appropriate body substance isolation precautions and are not in a CBRN environment.

**Standards:** Complete all of the steps required to open the casualty's airway without causing unnecessary injury.

### Performance Steps

1. Roll the casualty onto his back if necessary.
  - a. Kneel beside the casualty.
  - b. Raise the near arm and straighten it out above the head.
  - c. Adjust the legs so that they are together and straight or nearly straight.
  - d. Place one hand on the back of the casualty's head and neck.
  - e. Grasp the casualty under the arm with the free hand.
  - f. Pull steadily and evenly toward yourself, keeping the head and neck in line with the torso.
  - g. Roll the casualty as a single unit.
  - h. Place the casualty's arms at his side.
2. Establish the airway using the head-tilt/chin-lift or jaw thrust method.

**CAUTION:** Do not use this method if a spinal or neck injury is suspected.

- a. Head-tilt/chin-lift method.

**NOTE:** Remove any foreign material or vomitus seen in the mouth as soon as possible.

(1) With the casualty lying supine on a firm, flat surface, kneel beside the casualty's head.

(2) Place the palm of one hand on the casualty's forehead and the index and middle fingers of the other hand on the bony part of the jaw below the chin.

(3) Using equal pressure with both hands, tilt the casualty's head back as far as it will comfortably go.

**CAUTION:** Do not use thumb to lift the lower jaw. Do not press deeply into the soft tissue under the chin with the fingers. Do not completely close the casualty's mouth.

(4) Once the head is tilted back, release pressure on the chin to allow the mouth to open slightly.

- b. Jaw thrust maneuver.

**NOTE:** Use when a trauma injury is suspected, with an unknown mechanism of injury or when you believe the casualty has a spinal injury.

(1) With the casualty lying on a firm, flat surface, kneel at the top of the casualty's head.

(2) Place the thumbs on the cheekbones on either side of the casualty's face.

**CAUTION:** Do not rotate or tilt the casualty's head.

(3) Using the index and middle fingers of each hand at the angles of the casualty's jaw, push the jaw upward.

3. Check for breathing within 3 to 5 seconds. While maintaining the open airway position, place an ear over the casualty's mouth and nose, looking toward the chest and stomach.

- a. Look for the chest to rise and fall.
- b. Listen for air escaping during exhalation.
- c. Feel for the flow of air on the side of your face.

4. Take appropriate action.

a. If the casualty resumes breathing, maintain the airway and place the casualty in the recovery position.

- (1) Roll the casualty as a single unit onto his or her side.
- (2) Place the hand of the upper arm under his or her chin.
- (3) Flex the upper leg.

**NOTE:** Check the casualty for other injuries, if necessary.

b. If the casualty does not resume breathing, perform rescue breathing. (See task 081-831-0048.)

**Evaluation Preparation:**

Setup: Place a CPR mannequin or another Soldier acting as the patient, face down on the ground. For training and evaluation, you may specify to the Soldier whether the patient has a spinal injury to test step 2, or you may create a scenario in which the patient's condition will dictate to the Soldier how to treat the patient. After step 3 tell the Soldier whether the patient is breathing or not and ask what should be done.

Brief Soldier: Tell the Soldier to open the patient's airway.

<b>Performance Measures</b>	GO	NO GO
1 Rolled the casualty onto his back, if necessary.	_____	_____
2 Established the airway using the head-tilt/chin-lift or jaw thrust method.	_____	_____
3 Checked for breathing within 3 to 5 seconds.	_____	_____
4 Took appropriate action.	_____	_____
5 Did not cause further injury to the casualty.	_____	_____

**Evaluation Guidance:** Score each Soldier according to the performance measures in the evaluation guide. Unless otherwise stated in the task summary, the Soldier must pass all performance measures to be scored GO. If the Soldier fails any step, show what was done wrong and how to do it correctly.

**References**

**Required**  
SF 600

**Related**  
None

## Clear an Upper Airway Obstruction

081-831-0019

**CAUTION:** All body fluids should be considered potentially infectious. Always observe body substance isolation (BSI) precautions by wearing gloves and eye protection as a minimal standard of protection.

**Conditions:** You are evaluating a casualty who is not breathing or is having difficulty breathing, and you suspect the presence of an upper airway obstruction. You have performed a patient care hand wash, taken appropriate body isolation precautions and are not in a CBRN environment.

**Standards:** Complete, in order, all the steps necessary to clear an object from a casualty's upper airway. Continue the procedure until the casualty is able to speak and breathe normally or until relieved by a qualified person.

### Performance Steps

1. Determine whether the casualty needs your assistance.
2. If the casualty is lying down, bring him to a sitting or standing position.
3. Apply abdominal or chest thrusts.

**NOTE:** Use abdominal thrusts unless the casualty is in the advanced stages of pregnancy, is very obese, or has a significant abdominal wound.

#### a. Abdominal thrusts.

- (1) Stand behind the casualty and wrap your arms around his waist.
- (2) Make a fist with one hand and place the thumb side of your fist against the casualty's abdomen in the midline, slightly above the navel and well below the tip of the xiphoid process.
- (3) Grasp your fist with your other hand and press your fist into the casualty's abdomen with quick inward and upward thrusts.
- (4) Continue abdominal thrusts until the blockage is expelled or the casualty becomes unconscious.

**NOTE:** Make each thrust a separate, distinct movement given with the intent of relieving the obstruction.

#### b. Chest thrusts.

- (1) Stand behind the casualty and encircle his chest with your arms just under the armpits.
- (2) Make a fist with one hand and place the thumb side of the fist against the middle of the casualty's sternum.
- (3) Grasp your fist with your other hand and give backward thrusts, pressing your fist into the casualty's chest.

**CAUTION:** Do not position your hand on the xiphoid process or the lower margins on the rib cage.

- (4) Continue giving thrusts until the blockage is expelled or the casualty becomes unconscious.

**NOTE:** Administer each thrust with the intent of relieving the obstruction. If the casualty becomes unconscious, position the casualty on his back, open the airway. (See task 081-831-0018.) Observe the airway to look for the obstruction, and begin the steps of cardiopulmonary resuscitation (CPR).

4. Take appropriate action if the casualty becomes unconscious. Begin the steps of CPR.
  - a. Determine unresponsiveness.
  - b. Open the airway.

*NOTE:* Perform the head-tilt/chin-lift maneuver to clear an obstruction that is caused by the tongue and throat muscles relaxing back into the airway in any person who is found unconscious.

- c. Observe the airway to look for the obstruction.

*NOTE:* If the obstruction is visible, you may attempt to remove the object.

- d. Attempt ventilation.
- e. If the first ventilation does not produce visible chest rise, reposition the head and reattempt to ventilate.
- f. If both breaths fail to produce visible chest rise, perform 30 chest compressions and then open the airway and look into the mouth for the obstruction.
- g. Reattempt ventilation.

5. When the object is dislodged, check for breathing. Perform rescue breathing, if necessary (see task 081-831-0048) or continue to evaluate the casualty for other injuries.

**Evaluation Preparation:**

Setup: You will need another Soldier to play the part of the casualty. Instruct the casualty how to appear as though he has an obstructed airway; with consciousness progressing to unconsciousness. Instruct the casualty not to assist the Soldier in any way.

Brief Soldier: Describe the signs and symptoms of a casualty with good air exchange, poor air exchange, or a complete airway obstruction. Ask the Soldier what should be done and score step 1 based on the answer. Then tell the Soldier to clear an upper airway obstruction. Tell the Soldier to demonstrate how to position the casualty, where to stand and how to position his/her hands for the thrusts. The Soldier must tell you how they should be done and how many thrusts should be performed. Ensure that the Soldier understands that he/she must not actually perform the thrusts. After completion of step 5, ask the Soldier what must be done if the casualty becomes unconscious.

<b>Performance Measures</b>	GO	NO GO
1 Determined whether the casualty needed your assistance.	_____	_____
2 Moved the casualty to a sitting or standing position, if necessary.	_____	_____
3 Applied abdominal or chest thrusts.	_____	_____
4 Took appropriate action if the casualty became unconscious. Began the steps of CPR.	_____	_____
5 When the object was dislodged, checked for breathing. Performed rescue breathing, if necessary.	_____	_____

**Evaluation Guidance:** Score each Soldier according to the performance measures. Unless otherwise stated in the task summary, the Soldier must pass all performance measures to be scored GO. If the Soldier fails any step, show what was done wrong and how to do it correctly.

**References**

**Required**  
None

**Related**  
None

## Perform Rescue Breathing

081-831-0048

**CAUTION:** All body fluids should be considered potentially infectious. Always observe body substance isolation (BSI) precautions by wearing gloves and eye protection as a minimal standard of protection.

**Conditions:** You have a casualty who is unconscious and not breathing. You must perform rescue breathing. You will need a bag-valve-mask (BVM) system or flow-restricted oxygen-powered ventilation device (FROPVD), airway adjuncts, supplemental oxygen (O<sub>2</sub>), and pocket mask with one way valve. You have taken BSI (body substance isolation) precautions, and you are not in a CBRN environment.

**Standards:** Complete in order all the steps necessary to restore breathing. Continue the procedure until the casualty starts to breathe; you are relieved by another qualified person or medical officer, are not required to perform cardiopulmonary resuscitation (CPR) or are too exhausted to continue.

### Performance Steps

1. Position yourself at the side or directly above the casualty's head.
2. Open the airway. (See task 081-831-0018.)
  - a. Use the head-tilt/chin-lift maneuver when there is no suspected spinal injury.

**WARNING:** Foreign body airway obstruction (FBAO) such as those caused by food or small objects are difficult to see and can cause both partial and complete airway obstructions.

- b. Use the jaw thrust maneuver when trauma is observed or there is a suspected spinal injury.

**NOTE:** Several factors can make it difficult to establish a patent airway such as trauma to the face that causes swelling and bleeding that will make it difficult to keep the airway clear.

3. Ventilate the casualty using the mouth-to-mouth, mouth-to-nose, mouth-to-mask, BVM system, or flow-restricted oxygen-powered ventilation device FROPVD, as appropriate.

- a. Mouth-to-mouth method.

(1) Maintain the chin-lift while pinching the nostrils closed using the thumb and index fingers of your hand on the casualty's forehead.

(2) Take a regular breath and make an airtight seal around the casualty's mouth with your mouth.

(3) Give one slow breath (lasting one second) into the casualty's mouth, watching for the chest to rise and fall and listening and feeling for air to escape during exhalation.

**NOTE:** You must let go of the casualty's nose once you have given the breath and you are watching for the rise and fall of their chest, in order to feel the air escape upon your cheek.

- (4) If the chest rises and air escapes:

(a) Give a second slow breath.

(b) Go to step 6 (Check carotid pulse).

- (5) If the chest does not rise or air does not escape, go to step 4 (reposition head).

- b. Mouth-to-nose method.



*NOTE:* The mouth-to-nose method is recommended when you cannot open the casualty's mouth, there are jaw or mouth injuries, or you cannot maintain a tight seal around the casualty's mouth.

(1) Maintain the head-tilt with the hand on the forehead while using the other hand to lift the casualty's jaw and close the mouth.

(2) Take a regular breath and make an airtight seal around the casualty's nose with your mouth.

(3) Blow one full breath (lasting one second) into the casualty's nose while watching for the chest to rise and fall and listening and feeling for air to escape during exhalation.

*NOTE:* It may be necessary to open the casualty's mouth or separate the lips to allow air to escape.

(4) If the chest rises:

(a) Give a second full breath.

(b) Go to step 6.

(5) If the chest does not rise, go to step 4.

c. Mouth-to-mask.

*NOTE:* The face mask is an important part of infection control to the rescuer. Rescuer breaths are delivered to the casualty through the one-way valve of the mask. There is no direct contact with the casualty's mouth.

*NOTE:* Kneel above the casualty's head to perform this.

(1) Insert an appropriate airway adjunct.

(2) Connect the mask to an appropriate oxygen source, if available, at a flow rate of 15 liters per minute (lpm).

(3) Place the mask over the casualty's face, beginning at the top of the nose and walking the mask down so that it rests just below the lower lip.

(4) Using both hands, form a tight seal between the mask and the casualty's face while maintaining a head tilt or jaw thrust.

(5) Take a regular breath and exhale into the mask.

(a) If the breath goes in, give a second breath and go to step 6.

(b) If the breath fails to go in, go to step 4.

d. BVM system.

*NOTE:* Kneel above the casualty's head to perform this.

(1) Insert an appropriate airway adjunct.

(2) Connect BVM to oxygen at 15 lpm if available.

(3) Position the mask on the casualty's face.

(4) Form a "C" around the ventilation port. Hold your index finger over the lower part of the mask and your thumb over the upper part of the mask. Use the third, fourth and fifth fingers under the casualty's jaw to hold the mask in place.

*NOTE:* The most difficult part of performing rescue breathing using the BVM system is maintaining an adequate seal. The American Heart Association (AHA) recommends two rescuer

BVM ventilation; in this method, one rescuer maintains a two-hand seal while the other rescuer squeezes the bag.

(5) Squeeze the bag every five to six seconds. Deliver each breath over one second, just enough to produce visible chest rise.

(6) Release pressure from the bag and allow the casualty to exhale passively.

(a) If the chest rises and air goes in, squeeze the bag again to give a second breath and then go to step 6.

(b) If the chest fails to rise, go to step 4.

**CAUTION:** When using the FROPVD on casualties with chest injuries, be careful not to force excessive air into the stomach instead of the lungs. This may cause gastric distention and vomiting. Do not use this device on infants or children.

e. Flow-restricted oxygen-powered ventilation device (FROPVD).

(1) Follow the same steps to position and seal the mask as with the BVM system.

(2) Push the trigger/button on the device once.

(a) If the chest rises, push the trigger/button again and proceed to step 6.

(b) If the chest fails to rise, go to step 4.

4. Reposition the head to ensure an open airway and attempt the breath again if the chest does not rise or breath does not enter with first breath.

a. If the chest rises, give another breath and go to step 6.

b. If the chest does not rise, continue with step 5.

5. Clear an airway obstruction, if necessary. (See task 081-831-0019.) When the obstruction has been cleared, continue with step 6.

6. Check the carotid pulse for at least five seconds but no longer than 10 seconds.

a. While maintaining the airway, place the index and middle fingers of your hand on the casualty's throat.

b. Slide the fingers into the groove beside the casualty's Adam's apple and feel for a pulse for no longer than 10 seconds.

c. If a pulse is present, go to step 7.

d. If a pulse is not found, initiate CPR. (See task 081-831-0046.)

7. Continue rescue breathing.

a. Ventilate the casualty at the appropriate rate.

(1) Adult: 12-20 breaths per minute.

(2) Children (one year of age to the onset of puberty): 15-30 breaths per minute (mouth-to-mouth or mouth-to-nose).

(3) Infants (less than one year of age): 25-50 breaths per minute (mouth-to-nose).

b. Watch for rising and falling of the chest.

8. Complete all steps in order.

**Evaluation Preparation:**

Setup: For training and evaluation, a CPR mannequin must be used. Position the mannequin on its back. To test step 1, create a trauma or non-trauma scenario that will dictate which maneuver should be used. To test step 2, create a scenario in which the casualty's condition dictates which method is to be used. You may determine how much of the task is tested by telling the Soldier whether the airway is clear or a pulse is found as the Soldier proceeds through the task. However, you should ensure that the Soldier is routed through the task far enough to continue rescue breathing after checking the carotid pulse.

<b>Performance Measures</b>	GO	NO GO
1 Positioned yourself at the side or directly above the casualty's head.	_____	_____
2 Opened the airway. (See task 081-831-0018.)	_____	_____
3 Ventilated the casualty using the mouth-to-mouth, mouth-to-nose, mouth-to-mask, BVM, or FROPVD method, as appropriate.	_____	_____
4 Repositioned the head to ensure an open airway and repeated ventilation attempt, if necessary.	_____	_____
5 Cleared an airway obstruction, if necessary. (See task 081-831-0019.)	_____	_____
6 Checked the carotid pulse for at least five seconds but no longer than 10 seconds.	_____	_____
7 Continued rescue breathing.	_____	_____
8 Completed all steps in order.	_____	_____

**Evaluation Guidance:** Score each Soldier according to the performance measures. Unless otherwise stated in the task summary, the Soldier must pass all performance measures to be scored GO. If the Soldier fails any steps, show what was done wrong and how to do it correctly.

**References**

**Required**  
None

**Related**  
None

## Insert an Oropharyngeal Airway (J Tube)

081-833-0016

**WARNING:** Use an oropharyngeal airway (OPA) adjunct for an unconscious casualty only. Do not use an OPA adjunct on a conscious or semiconscious casualty because they may still have an active gag reflex. In such cases, a nasopharyngeal airway (NPA) adjunct would be more appropriate. An OPA should not be used in children who may have ingested a caustic or petroleum-based product, as it may induce vomiting.

**CAUTION:** All body fluids should be considered potentially infectious. Always observe body substance isolation (BSI) precautions by wearing gloves and eye protection as a minimal standard of protection.

**Conditions:** You have an unconscious casualty requiring an oropharyngeal airway adjunct, (OPA). You will need three different sized OPAs, gauze pads or disposable tongue depressors. You have performed a patient care hand wash and body substance isolation precautions are taken. You are not in a CBRN environment.

**Standards:** Insert an OPA without causing further injury to the casualty.

### Performance Steps

1. Select the appropriate size of OPA.
  - a. Place the airway beside the outside of the casualty's jaw.
  - b. Measure from the casualty's ear lobe to the corner of the mouth.

*NOTE:* The measurement from the ear lobe to the corner of the casualty's mouth is equivalent to the depth of insertion in the airway.

**WARNING:** If a neck or spinal injury is suspected, use the jaw thrust maneuver to open the airway.

2. Perform the head-tilt/chin-lift or jaw thrust maneuver to open the airway. (See task 081-831-0018.)
3. Open the casualty's mouth.
  - a. Place the crossed thumb and index finger of one hand on the casualty's upper and lower teeth at the corner of the mouth.
  - b. Use a scissors motion to pry the casualty's teeth apart.

*NOTE:* If the teeth are clenched, wedge the index finger behind the casualty's back molars to open the mouth.

4. Insert the OPA.
  - a. Insert the airway with the tip facing the roof of the mouth.
  - b. Slide the OPA along the roof of the mouth. Follow the natural contour of the tongue past the soft palate.
  - c. Rotate the airway 180 degrees as the tip reaches the back of the tongue.

*NOTE:* The airway may be difficult to insert. If so, use a gauze pad to pull the tongue forward or a tongue blade to depress the tongue.

**WARNING:** If the casualty starts to regain consciousness and gags or vomits, remove the airway immediately.

d. Gently advance the airway and adjust it so the flange rests against the casualty's lips or teeth.

*NOTE:* The tip of the airway should rest just above the epiglottis. If the flange of the airway did not seat correctly on the lips, repeat the procedure using a different size of airway.

5. Evacuate the casualty.

*NOTE:* The airway may need to be taped or tied in place to avoid dislodgement during evacuation. If so, the casualty must be constantly monitored for the return of consciousness.

6. Did not cause further injury to the casualty.

**Evaluation Preparation:**

Setup: For training and evaluation, use a cardiopulmonary resuscitation (CPR) mannequin capable of accepting an OPA.

Brief Soldier the simulated casualty is unconscious and breathing. The casualty does not have an active gag reflex.

<b>Performance Measures</b>	GO	NO GO
1 Selected the appropriate size of OPA.	_____	_____
2 Performed the head-tilt/chin-lift or jaw thrust maneuver.	_____	_____
3 Opened the casualty's mouth using scissors technique.	_____	_____
4 Inserted the OPA.	_____	_____
5 Evacuated the casualty.	_____	_____
6 Did not cause further injury to the casualty.	_____	_____

**Evaluation Guidance:** Score each Soldier according to the performance measures. Unless otherwise stated in the task summary, the Soldier must pass all performance measures to be scored GO. If the Soldier fails any steps, show what was done wrong and how to do it correctly.

**References**

**Required**  
None

**Related**  
None

## Ventilate a Patient with a Bag-Valve-Mask System

081-833-0017

**CAUTION:** All body fluids should be considered potentially infectious. Always observe body substance isolation (BSI) precautions by wearing gloves and eye protection as a minimal standard of protection.

**Conditions:** You have an unconscious patient requiring ventilation. You will need a bag-valve-mask (BVM) system, oropharyngeal airway (OPA), supplemental oxygen (if available), a DD Form 1380 US Field Medical Card (FMC) and pen. You have performed a patient care hand wash. You are not in a CBRN environment.

**Standards:** Ventilate the patient with a BVM system until spontaneous breathing returns, until a normal rate and depth of respiration is achieved, or until directed to stop by a medical officer.

### Performance Steps

1. Take appropriate body substance isolation.
2. Position yourself at the top of the patient's head.
3. Open the patient's airway using the head-tilt, chin-lift or jaw thrust maneuver. (See task 081-833-0018.)

*NOTE:* An operational BVM should have a self-refilling bag, a non-rebreathing outlet valve, oxygen reservoir, a one-way inlet valve, and a transparent face mask.

4. Insert an appropriate airway adjunct. (See task number 081-833-0016.)

*NOTE:* Do not attempt to use an oropharyngeal airway (OPA) on a conscious or semiconscious patient. If the patient is unresponsive an OPA or a nasopharyngeal airway (NPA) should be inserted to help maintain a patent airway.

5. Assemble the BVM system, selecting the correct size of mask for the patient.

*NOTE:* Ensure the bag is operational. An operational BVM should have a self-refilling bag, a non-rebreathing outlet valve, oxygen reservoir and a transparent face mask.

6. Perform an E-C technique to hold mask in place over patient's mouth.
  - a. Your thumb should be placed over the part of the mask covering the bridge of the nose and your index finger is placed over the part covering the cleft above the chin.
  - b. Seal the mask firmly on the face by pushing down with the thumb and index finger while pulling up on the mandible with the other finger to maintain the head-tilt, chin-lift maneuver.
  - c. The E-C hand position technique will be performed using one hand.
7. Ventilate the patient using the one-rescuer method, if appropriate.
  - a. Maintain a leak proof mask seal with one hand. Use firm pressure to hold the mask in position and to maintain a seal on the patient's face.
  - b. Squeeze the bag with one hand while observing the chest rise to make certain the lungs are being inflated effectively.

*NOTE:* The bag may alternatively be compressed against your body or forearm to deliver a greater tidal volume to the patient or help with hand fatigue.

- c. Ventilate patient for approximately one minute and then connect to oxygen (if available) to increase the percentage of oxygen from 55% to approximately 90-100%.
- d. Continue squeezing the bag once every five to six seconds (10-12 breaths/minute), for an adult patient.

8. Ventilate the patient using the two-rescuer method, if appropriate.
  - a. Hold the mask in place with two hands.
    - (1) Place your little, ring, and middle fingers along the mandible.
    - (2) Place your thumb on the upper portion of the mask above the valve connection.
    - (3) Place your index finger on the lower portion of the mask under the valve connection.
    - (4) With your other hand, duplicate the above steps (mirror image) to achieve a leak proof seal.
  - b. Have your assistant continue squeezing the bag with two hands until the chest rises; squeeze once every five to six seconds (10-12 breaths/minute), for an adult.

*NOTE:* Oxygen should be connected to the reservoir (if available) at 15 lpm. This will increase the oxygen from 55% to approximately 90-100%. Ventilations should not be interrupted for more than 30 seconds at any time.

9. Observe for rise and fall of the patient's chest.
  - a. If the chest does not rise, reposition the airway.
  - b. If the chest rises and falls, continue with step 10.
10. Continue ventilations.
  - a. Observe for spontaneous respirations.
  - b. Periodically check the pulse.
  - c. Observe for vomiting or secretions in or around the mouth or mask.
11. Document all medical care and procedures on the FMC.
12. Evacuate the patient.
13. Do not cause further injury to the patient.

**Evaluation Preparation:**

Setup: For training and evaluation, use a cardiopulmonary resuscitation (CPR) mannequin capable of accepting an OPA. Have another Soldier act as an assistant. If oxygen will be used, prepare the oxygen source. Tell the Soldier if oxygen is to be used and whether the patient is conscious or unconscious. Have the Soldier insert an OPA and ventilate the patient with a BVM using the one rescuer method and two rescuer methods. After 2 minutes of ventilation, tell the Soldier that the patient has resumed normal breathing. Tell the assisting Soldier only to perform those actions the Soldier being evaluated directs them to perform.

<b>Performance Measures</b>	GO	NO GO
1 Took body substance isolation (BSI) precautions.	_____	_____
2 Positioned themselves at the top of the patient's head.	_____	_____
3 Opened the patient's airway using the head-tilt, chin-lift or jaw thrust maneuver. (See task 081-833-0018.)	_____	_____
4 Inserted appropriate airway adjunct. (See task 081-833-0016.)	_____	_____
5 Assembled the BVM system and selected the correct sized mask for patient.	_____	_____

<b>Performance Measures</b>	GO	NO GO
6 Performed the E-C technique.	_____	_____
7 Ventilated the patient using the one-rescuer method, if appropriate.	_____	_____
8 Ventilated the patient using the two-rescuer method, if appropriate.	_____	_____
9 Observed for rise and fall of the patient's chest.	_____	_____
10 Continued ventilations.	_____	_____
11 Documented the procedure on FMC.	_____	_____
12 Evacuated the patient.	_____	_____
13 Did not cause further injury to the patient.	_____	_____

**Evaluation Guidance:** Score each Soldier according to the performance measures in the evaluation guide. Unless otherwise stated in the task summary, the Soldier must pass all performance measures to be scored a GO. If the Soldier fails any step, show what was done wrong and how to do it correctly.

**References**

**Required**  
DD Form 1380

**Related**  
None



## Perform Oral Suctioning

**081-833-0099**

**Conditions:** You have a patient that requires suctioning. You will need a portable suction apparatus, (a suction kit if available), suction tubing, a rigid or flexible suction catheter, saline solution, a basin, a collection bottle, a pen, and a SF 600 Chronological Record of Medical Care. You have performed a patient care hand wash. You are not in a CBRN environment.

**Standards:** Perform oral suctioning to clear the airway without causing injury to the patient.

*NOTE :* Wear eye protection when performing suctioning procedures.

**CAUTION:** All body fluids should be considered potentially infectious. Always observe body substance isolation (BSI) precautions by wearing gloves and eye protection as a minimal standard of protection.

1. Position the conscious patient in a semi-Fowler's (semi-sitting) position or, in the case of severe trauma, roll the patient onto his side to allow gravity to assist in clearing the airway.

*NOTE:* In some cases, such as spinal injuries, the patient must remain in whatever position they are initially found in or must be managed while they are immobilized on a long spine board.

2. Turn on the suction unit to see if it is operational.

*NOTE :* Inspect the suction unit regularly to ensure it is in working condition. Switch on the suction, clamp the tubing, and make certain the unit generates a vacuum of more than 300 mm Hg. Check that a battery-charged unit has charged batteries.

3. Select the appropriate catheter and attach it to the suction tubing.
  - a. Tonsil-tip (Yankauer) catheters are best for suctioning in the field, as they have wide diameter tips and are somewhat rigid.

*NOTE:* Suction catheters must be disposable and capable of being connected to the suction unit's tubing.

- b. If the nasal passages need to be suctioned, select a soft, flexible (French or Whistle Tip) catheter and use low to medium suction (80-120 mmHg).

*NOTE:* Flexible (French, or whistle-tip) catheters are used in situations where rigid catheters cannot be used, such as a patient with clenched teeth or for use in nasopharyngeal suctioning.

4. Prepare equipment.
  - a. Open the basin package.
  - b. Pour the saline solution into the basin. c. Open the suction catheter package.
5. Explain to the patient the reason for suctioning.
6. Pre-oxygenate the patient with 100% oxygen.
  - a. If the patient is receiving oxygen therapy, increase the oxygen to 100% for 1 minute.
  - b. Monitor the patient's pulse oximeter reading during the entire procedure. (See task 081-833-0164.)
  - c. If the patient is not receiving oxygen therapy, have him take a minimum of five deep breaths or administer the breaths with a bag-valve-mask (BVM) system.

*NOTE:* After each suctioning attempt or suctioning period, re-oxygenate the patient.

7. Put on gloves.
8. Remove the catheter from the package using your dominant hand.
9. Test the patency of the catheter.
  - a. Turn the suction unit on with your non-dominant hand.
  - b. Pick up attached suction tubing using your non-dominant hand.

*NOTE:* The suction tubing is considered contaminated. After this is touched, then that hand is considered contaminated.

- c. Attach catheter being held by dominant hand to suction tubing being held by your non-dominant hand.
- d. Insert the catheter tip into the saline solution using your dominant hand.

*NOTE:* Moistening the catheter lubricates the catheter and helps to minimize trauma to the mucous membranes and increases the patient's comfort.

- e. Occlude the suction control port with your non-dominant thumb and observe the saline entering the drainage bottle. Note: If no saline enters the bottle, check the suction unit and/or replace the catheter and retest for patency.
10. Suction the patient.
    - a. Rigid catheter.
      - (1) Instruct a conscious patient to cough to help bring secretions up to the back of his throat.
      - (2) If the patient is unconscious, use the cross finger method of opening the airway. (See task 081-831-0019.)
      - (3) Place the convex (outward curving) side of the rigid tip against the roof of the mouth and insert to the base of the tongue.

*NOTE:* A rigid tip does not need to be measured. Only insert the tip as far as you can see it. Be aware that advancing the catheter too far may stimulate the patient's gag reflex and cause him to vomit.

**WARNING:** Never suction for more than 15 seconds at one time for adults, 10 seconds for children and 5 seconds for infants. Longer periods of continuous suctioning may cause oxygen deprivation.

- (4) Apply suction by placing the thumb of your non-dominant hand over the suction control port.
  - (5) Clear the secretions from the catheter between each suctioning interval by inserting the tip into the saline solution and suction the solution through the catheter until the catheter is clear of secretions.
  - (6) Repeat steps 10a(1) through 10a(5) until all secretions have been removed or until the patient's breathing becomes easier. Noisy, rattling or gurgling sounds should no longer be heard.
- b. Flexible catheter.
    - (1) Measure the catheter from the patient's earlobe to the corner of the mouth or the center of the mouth to the angle of the jaw.

**WARNING:** Insert the catheter no farther down than the base of the tongue.

(2) Insert the catheter into the patient's mouth to the correct depth, without the suction applied.

**NOTE:** If an oropharyngeal airway (OPA) is in place, insert the catheter alongside the airway and then back into the pharynx.

(3) Place the thumb of your non-dominant hand over the suction control port on the catheter, applying intermittent suction by moving your thumb up and down over the suction control port.

(4) Apply suction in a circular motion as you withdraw the catheter.

**WARNING:** Advancing the catheter too far into the back of the patient's throat may stimulate the gag reflex. This could cause vomiting and the aspiration of stomach contents.

(5) Suction for no longer than 15 seconds removing secretions from the back of the throat, along outer gums, cheeks, and base of tongue.

(6) Clear the secretions from the catheter between suctioning by inserting the tip into the saline solution and suction the solution through the catheter until the catheter is clear of secretions.

(7) Repeat steps 10b(2) through 10b(6) until all secretions have been removed or until the patient's breathing becomes easier. Noisy, rattling or gurgling sounds should no longer be heard.

11. Re-oxygenate the patient and/or ventilate for at least five assisted ventilations.

12. Observe the patient for hypoxemia.

a. Color change.

**WARNING:** Discontinue suctioning immediately if severe changes in color or pulse rate occur.

b. Increased or decreased pulse rate.

13. Place the patient in the recovery (lateral recumbent, coma) position.

14. Record the procedure on the SF 600.

15. Do not cause further injury to the patient.

**Evaluation Preparation:**

Setup: For training and evaluation, use another Soldier to be the simulated patient.

Brief Soldier: Tell the Soldier the simulated patient has a respiratory emergency and they will need to initiate treatment.

<b>Performance Measures</b>	GO	NO GO
1    Positioned the patient.	_____	_____
2    Turned on the assembled unit and checked to see if it is operational.	_____	_____
3    Selected the appropriate catheter.	_____	_____
4    Prepared the equipment.	_____	_____
5    Explained to the patient the reason for suctioning.	_____	_____
6    Pre-oxygenated the patient with 100% oxygen.	_____	_____

<b>Performance Measures</b>	GO	NO GO
7 Put on sterile or clean gloves as ordered.	_____	_____
8 Removed the catheter from the package.	_____	_____
9 Tested the patency of the catheter.	_____	_____
10 Suctioned the patient.	_____	_____
11 Re-oxygenated and/or ventilated the patient.	_____	_____
12 Observed the patient for hypoxemia.	_____	_____
13 Placed the patient in the recovery position.	_____	_____
14 Recorded the procedure on SF 600.	_____	_____
15 Did not cause further injury to the patient.	_____	_____

**Evaluation Guidance:** Score each Soldier according to the performance measures in the evaluation guide. Unless otherwise stated in the task summary, the Soldier must pass all performance measures to be scored a GO. If the Soldier fails any step, show what was done wrong and how to do it correctly.

**References**

**Required**  
SF 600

**Related**  
None

## Administer Oxygen

**081-833-0158**

**CAUTION:** All body fluids should be considered potentially infectious. Always observe body substance isolation (BSI) precautions by wearing gloves and eye protection as a minimal standard of protection.

**Conditions:** You have a patient requiring oxygen administration. You will need an oxygen tank with a PIN index system, a pressure regulator with a pressure gauge an adjustable-liter-flow outlet, a key or wrench, sterile water, humidifier, non-rebreather mask (NRB) with extension tubing, a nasal cannula, pen and SF 600 (Medical Record Chronological Record of Medical Care). You have taken body substance isolation precautions and you are not in a CBRN environment.

**Standards:** Administer oxygen therapy using an NRB mask or nasal cannula to assist the patient's breathing without causing further harm to the patient. Calculate the duration of flow of the oxygen.

### Performance Steps

1. Explain procedure to patient.
2. Assemble the equipment.

*NOTE:* Ensure the cylinder (bottle or tank) is labeled for medical oxygen. All medical grade oxygen cylinders are color coded green, silver or chrome to make easy identification of the cylinder. They come in a variety of sizes, each size designated by a specific color.

- a. Remove protective seal.
- b. Crack the main cylinder for one second to remove dust, debris, and check for leaks.

*NOTE:* Make sure cylinder is stabilized during entire process of assembly and once in use by patient.

- c. Place yoke of the regulator over the cylinder valve and align the pins.
- d. Hand-tighten the T-screw on the regulator.
- e. Open the main cylinder valve to check the pressure.

*NOTE:* The safe residual level of the oxygen at which the cylinder should be replaced has been established to be 200 pounds per square inch (psi).

**WARNING:** Disposable humidifiers are available for one-time use.

**CAUTION:** Humidified oxygen is usually more comfortable to the patient and is particularly helpful for children and for chronic obstructive pulmonary disease (COPD) patients. They provide moisture to the dry oxygen.

- f. Attach the oxygen delivery device to the regulator.

*NOTE:* Compressed oxygen that is stored in cylinders is extremely dry and can cause dryness and irritation to the mucous membranes, especially in the nasal passages.

3. Position patient in position of comfort.

4. Determine oxygen delivery device.

a. A bag-valve-mask (BVM) system is the delivery device of choice for patient's with signs of severe inadequate breathing. (See task 081-833-0017.)

b. A non-rebreather mask (NRB) is usually the delivery device of choice in the prehospital setting for patients with signs of inadequate breathing, who are cyanotic, have chest pain, severe trauma, signs of shock or an altered mental status.

c. A nasal cannula is appropriate for those who are unable to tolerate a NRB.

5. Administer oxygen with appropriate device.

a. Apply the NRB.

(1) Select the correct sized mask.

*NOTE:* The apex of the mask should fit over the bridge of the patient's nose and extend to rest on the chin, covering the mouth and nose completely. NRB masks come in different sizes for adults, children and infants.

(2) Connect tubing to regulator.

(3) Set the regulator to 15 lpm (liters per minute). The oxygen concentration delivered is usually around 90 percent.

(4) Fill the reservoir bag completely.

*NOTE:* You may need to press down on the rubber valve gasket found covering the one-way valve between the mask and the reservoir. This will cause the bag to fill much faster.

(5) Fit mask to patient's face.

(a) Bring elastic strap around the back of the head and secure it.

(b) Form the soft metal piece at the top of the mask to conform to the patient's nose.

(c) Instruct the patient to breathe normally.

(d) Continually monitor the reservoir bag to ensure that it remains filled during inhalation.

b. Apply the nasal cannula.

(1) Connect tubing to regulator.

(2) Insert the two prongs of the cannula into the patient's nostrils with the tab pointing down.

*NOTE:* Make sure nasal prongs are pointing downward.

**WARNING:** Do not make tubing too tight. If an elastic strap is used, adjust it so it is secure and comfortable.

(3) Position tubing over and behind each ear. Gently secure it by sliding the adjuster underneath the chin.

(4) Set the regulator to 1-6 lpm. The delivered oxygen concentration ranges from 22% to 44%.

(5) Instruct patient to breathe normally.

(6) Check the cannula position periodically to ensure that it has not dislodged.

6. Continue to monitor patient.

*NOTE:* Continue to monitor patient for worsening vital signs, confusion, restlessness and altered mental status.

7. Check the equipment.

**NOTE:** Ensure tubing connections and device are secure, especially with movement of the patient. Monitor oxygen flow. Change the delivery device and tubing every 24 hours, or more often IAW local protocols. If humidifier is attached, water should be changed every shift or more often IAW with local protocols.

8. Calculate the duration of flow of the oxygen cylinder.
  - a. Determine the remaining pressure in the tank by reading the regulator guage.
  - b. Determine the safe residual level of the oxygen cylinder.

**NOTE:** The safe residual level of the oxygen at which the cylinder should be replaced has been established to be 200 psi.

c. Determine the available cylinder pressure by subtracting the safe residual level from the remaining pressure. Example: 2,000 psi remaining pressure minus 200 psi safe residual level = 1,800 psi available pressure.

- d. Determine the conversion factor for the oxygen cylinder in use.

**NOTE:** Each type of oxygen cylinder, depending on its size, employs a specific conversion factor. D size oxygen cylinder-0.16; E size oxygen cylinder-0.28; G size oxygen cylinder-2.41; H size oxygen cylinder-3.14; K size oxygen cylinder-3.14; M size oxygen cylinder-1.56.

e. Determine available liters by multiplying the conversion factor by the amount of available pressure. Example: A D size cylinder is being used. 0.16 conversion factor x 1,800 psi available pressure = 288 liters of oxygen available for use.

- f. Determine the flow rate as prescribed by medical direction.

- g. Determine the duration of the oxygen by dividing the available liters by the flow rate.

Example: 288 available liters divided by the prescribed flow rate of 15 lpm = 19.2 minutes duration of oxygen flow.

9. Follow safety precautions.

a. Never allow combustible materials such as oil or grease to touch the cylinder, regulator, fittings, valves or hoses.

b. Ensure "OXYGEN" and "NO SMOKING" signs are posted wherever oxygen is used or stored.

**WARNING:** The principle danger in using oxygen is fire. The presence of oxygen in increased concentrations makes all materials more combustible. Materials that burn slowly in ordinary air, burn violently and even explosively in the presence of oxygen.

- c. Inform the patient and visitors about the restrictions.
- d. Use only non-sparking wrenches on oxygen cylinders.
- e. Position oxygen cylinders away from doors and high traffic areas.
- f. Secure and store oxygen cylinders in an upright position.

**WARNING:** When you are working with an oxygen cylinder, never place any part of your body over the cylinder valve. A full cylinder is at 2,000 psi and if the tank is punctured or if a valve breaks off, any oxygen cylinder can accelerate with enough force to penetrate concrete walls.

13. Do not cause further injury to the patient.

**WARNING:** A loosely fitting regulator can be blown off the cylinder with sufficient force to decapitate a person, penetrate the body or demolish any object in its path.

g. Keep all valves closed when the oxygen cylinder is not in use, even if the tank is empty.

**Evaluation Preparation:**

Setup: For training and evaluation, have another Soldier act as the patient; tell the patient not to assist the Soldier in any way. Place the unassembled oxygen cylinder and regulator along with a non-sparking wrench, NRB mask, extension tubing and nasal cannula next to the patient. Once the NRB has been placed on the patient, inform the Soldier that the patient is not able to tolerate the NRB mask. The Soldier should then substitute the nasal cannula for the NRB.

<b>Performance Measures</b>	GO	NO GO
1 Explained procedure.	_____	_____
2 Assembled equipment.	_____	_____
3 Positioned patient.	_____	_____
4 Determined oxygen delivery device.	_____	_____
5 Administered oxygen with appropriate device.	_____	_____
6 Monitored patient.	_____	_____
7 Checked equipment.	_____	_____
8 Calculated duration of flow.	_____	_____
9 Followed safety precautions.	_____	_____

**Evaluation Guidance:** Score each Soldier according to the performance measures. Unless otherwise stated in the task summary, the Soldier must pass all performance measures to be scored a GO. If the Soldier fails any steps, show what was done wrong and how to do it correctly.

**References**

**Required**  
SF 600

**Related**  
None



**Insert a King LT**

**081-833-0230**

**Conditions:** An unconscious casualty requires the insertion of an esophageal King LT. An assistant is performing resuscitative measures. No cervical spine injury is present. You will need a King LT, syringe provided in kit based on size, gloves, stethoscope, and bag-valve-mask (BVM). You are not in a CBRN environment.

**Standards:** Insert the King LT without causing further injury.

**Performance Steps**

1. Take body substance isolation (BSI) precautions.
2. Inspect the upper airway for visible obstruction.
3. Choose correct King LT size, based on patient height.
4. Inspect and test equipment.
5. Lubricate the distal end of the tube.
6. Direct the assistant to pre-oxygenate casualty.
7. Perform a tongue-jaw lift with non-dominant hand.
8. Insert the device until the base connector is aligned with the casualty's teeth.
9. Inflate the cuffs with the appropriate amount of air based on the size of the tube.
  - a. Use size 3 if the casualty is less than 61 inches in height. Inflate with 45-60 ml of air.
  - b. Use size 4 if the casualty is 61 inches to 71 inches in height. Inflate with 60-80 ml of air.
  - c. Use size 5 if the casualty is taller than 71 inches in height. Inflate with 70-80 ml of air.
10. Direct the assistant to ventilate the casualty with a BVM.
11. Confirm proper placement by auscultation and chest movement.
12. Assess casualty for spontaneous respirations, if any, for 10 seconds.
13. Attach pulse oximeter to casualty, if available.
14. Ventilate casualty when respirations are <8 or > 30 or a pulse oximeter reading <90%.
15. Secure the device to the casualty using tape.

**Evaluation Preparation:** None.

<b>Performance Measures</b>	<b>GO</b>	<b>NO GO</b>
1 Took BSI precautions.	_____	_____
2 Inspected the upper airway for visible obstruction.	_____	_____
3 Chose correct King LT size based on patient height.	_____	_____
4 Inspected and tested the equipment.	_____	_____
5 Lubricated the distal end of the tube.	_____	_____
6 Directed the assistant to pre-oxygenate casualty.	_____	_____
7 Performed a tongue-jaw lift.	_____	_____

<b>Performance Measures</b>	GO	NO GO
8 Inserted the device until the base connector was aligned with the casualty's teeth.	_____	_____
9 Inflated the cuffs with the appropriate amount of air based on the size of the tube.	_____	_____
10 Directed the assistant to ventilate the casualty with a BVM.	_____	_____
11 Confirmed proper placement by auscultation or chest movement.	_____	_____
12 Assessed casualty for spontaneous respirations, if any, for 10 seconds.	_____	_____
13 Attached pulse oximeter to casualty, if available.	_____	_____
14 Ventilated casualty when respirations were <8 or > 30 or a pulse oximeter reading <90%.	_____	_____
15 Secured the device to the casualty.	_____	_____

**Evaluation Guidance:** Score each Soldier according to the performance measures. Unless otherwise stated in the task summary, the Soldier must pass all performance measures to be scored GO. If the Soldier fails any steps, show what was done wrong and how to do it correctly.

**References**

**Required**  
None

**Related**  
None

## Perform a Surgical Cricothyroidotomy

081-833-3005

**CAUTION:** Casualties with a total upper airway obstruction, inhalation burns, or massive maxillofacial trauma who cannot be ventilated by other means are candidates for a surgical cricothyroidotomy.

**Conditions:** You have a casualty requiring a surgical cricothyroidotomy. You will need a cutting instrument (scalpel, knife blade), airway tube (endotracheal (ET) tube, tracheotomy tube, or any non-collapsible tube, suctioning apparatus, alcohol swabs, knife handle, gloves, and tape. You are not in a CBRN environment.

**Standards:** Perform a surgical cricothyroidotomy without causing unnecessary injury to the casualty.

### Performance Steps

1. Gather cricothyroidotomy kit or minimum essential equipment.

*NOTE:* Because of the need for speed, every medic should have an easily accessible cricothyroidotomy kit that contains all required items.

- a. Cutting instrument: No. 10 or 15 scalpel or knife blade.
- b. Airway tube: ET tube, tracheotomy tube, or any non-collapsible tube that will allow enough airflow to maintain oxygen saturation.

*NOTE:* In a field setting, an ET tube is preferred because it is easy to secure. Use a size 6.0 to 7.0 ET tube, and ensure the cuff will hold air.

2. Put on gloves.

**WARNING:** Do not hyperextend the casualty's neck if a cervical injury is suspected.

3. Hyperextend the casualty's neck.
  - a. Place the casualty in the supine position.
  - b. Place a blanket or poncho rolled up under the casualty's neck or between the shoulder blades to hyperextend the neck.
4. Locate the cricothyroid membrane.
  - a. Place a finger of the non-dominant hand on the thyroid cartilage (Adam's apple), and slide the finger down to the cricoid cartilage.
  - b. Palpate for the soft cricothyroid membrane below the thyroid cartilage and just above the cricoid cartilage.
  - c. Slide the index finger down into the depression between the thyroid and cricoid cartilage.
  - d. Prepare the skin over the membrane with an alcohol swab.
5. Stabilize the larynx with the non-dominant hand.
6. With the cutting instrument in the dominant hand, make a 1 1/2 inch vertical incision through the skin over the cricothyroid membrane.

*NOTE:* A vertical incision will allow visualization of the cricothyroid membrane, but keep the scalpel blade away from the lateral aspect of the neck. This is important because of the large blood vessels located in the lateral areas of the neck.

**CAUTION:** Do not cut the cricothyroid membrane with this incision.

7. Maintain the opening of the skin incision by pulling the skin taut with the fingers of the non-dominant hand.

8. Stabilize the larynx with one hand and cut horizontally through the cricothyroid membrane.

9. Insert a commercially designed cricothyroidotomy hook or improvise with the tip of an 18-gauge needle formed into a hook through the opening; hook the cricoid cartilage, and lift to stabilize the opening.

10. Insert the end of the ET tube or tracheotomy tube through the opening and towards the lungs. The tube should be in the trachea and directed toward the lungs. Inflate the cuff 10 cubic centimeters (cc) of air.

11. Assess the casualty for spontaneous respirations (10 seconds).

12. Attach a pulse oximeter to the casualty, if available.

13. Assist with ventilations when respirations are <8 or >30 or a pulse oximeter reading <90%. Direct an assistant to ventilate the casualty with a BVM, if necessary.

14. Auscultate lung fields and watch for rise and fall of the chest to confirm tube placement.

15. Secure the tube, using tape, cloth ties, or other measures, and apply a dressing to further protect the tube and incision.

16. Monitor the casualty's respirations on a regular basis.

a. Reassess air exchange and placement every time the casualty is moved.

b. Assist with respirations if the respiratory rate falls below 8 or rises above 30 per minute.

**Evaluation Preparation:**

Setup: For training and evaluation, use a mannequin. If a Soldier is used UNDER NO circumstances is the skin to actually be incised. Have the evaluated Soldier explain the procedure verbally.

<b>Performance Measures</b>	GO	NO GO
1 Gathered equipment.	_____	_____
2 Put on gloves.	_____	_____
3 Hyperextended the casualty's neck.	_____	_____
4 Located the cricothyroid membrane and cleaned with an alcohol swab.	_____	_____
5 Stabilized the larynx with the non-dominant hand.	_____	_____
6 Made a 1 1/2 inch vertical incision over the cricothyroid membrane, with the cutting instrument in the dominant hand.	_____	_____
7 Maintained the opening of the skin incision by pulling the skin taut with the fingers of the non-dominant hand.	_____	_____
8 Cut horizontally through the cricothyroid membrane.	_____	_____
9 Maintained the opening of the cartilage with a tracheal hook or other device.	_____	_____
10 Inserted the end of the ET tube into the trachea and directed towards the lungs 1/4 inch beyond the cuff.	_____	_____

<b>Performance Measures</b>	GO	NO GO
11 Assessed the casualty for spontaneous respirations (10 seconds).	_____	_____
12 Attached a pulse oximeter to the casualty, if available.	_____	_____
13 Assisted with ventilations when respirations were <8 or >30 or a pulse oximeter reading <90%. Directed an assistant to ventilate the casualty with a BVM, if necessary.	_____	_____
14 Auscultated lung fields and watched for rise and fall of the chest to confirm tube placement.	_____	_____
15 Secured the tube and applied a dressing to further protect the tube and incision.	_____	_____
16 Monitored the casualty's respirations.	_____	_____

**Evaluation Guidance:** Score each Soldier according to the performance measures in the evaluation guide. Unless otherwise stated in the task summary, the Soldier must pass all performance measures to be scored a GO. If the Soldier fails any step, show what was done wrong and how to do it correctly.

**References**

**Required**  
None

**Related**  
None

## Subject Area 5: Venipuncture and IV Therapy

### Obtain a Blood Specimen

081-833-0101

**Conditions:** You have a patient that needs to have a blood specimen drawn. You will need blood specimen tubes, constricting band, vacutainer adapter, vacutainer needles, disinfectant pads, sterile 2 x 2 gauze sponges, betadine or alcohol, adhesive bandage strips, protective pad, labels, and gloves. You are not in a CBRN environment.

**Standards:** Obtain a blood specimen without causing injury to the patient or violating aseptic technique.

#### Performance Steps

1. Verify the medical officer's order to obtain a blood specimen.
2. Select the proper blood specimen tube for the ordered test.
3. Label the blood specimen tube with the information necessary to identify the patient in accordance with (IAW) local standard operating procedure (SOP).

**WARNING:** Gloves should be worn for self-protection against transmission of contaminants whenever handling body fluids.

4. Perform a patient care handwash.
5. Put on gloves.
6. Assemble the vacutainer adapter, the needle, and the blood specimen tube.
  - a. Inspect the needle for nicks or barbs. Replace the needle if it is flawed or dull.
  - b. Insert the rubber stoppered end of the specimen tube into the vacutainer holder and advance the tube until it is even with the guideline.
7. Identify the patient using two patient identifiers IAW local SOP.
8. Explain the procedure and purpose for collecting the blood specimen to the patient.
9. Position the patient.

**WARNING:** Never attempt to draw blood from a standing patient.

- a. Assist the patient into a comfortable sitting or lying position.
  - b. The patient should be positioned so the arm is well supported and stabilized by using a pillow, table, or other flat surface.
  - c. Place a protective pad under the elbow and forearm.
10. Expose the area for venipuncture.

**WARNING:** Do not use the vacutainer to draw blood from small or fragile veins because this can cause the vein wall to collapse. Use a needle and syringe instead.

**CAUTION:** Avoid veins that are infected, irritated, injured or have an intravenous (IV) injection running distal to the proposed venipuncture site.

11. Select and palpate one of the prominent veins in the bend of the arm (antecubital space).
  - a. The first choice is the median cubital vein. It is well supported and least apt to roll.

- b. The second choice is the cephalic vein.
  - c. The third choice is the basilic vein. Although it is often the most prominent, it tends to roll easily and makes venipuncture difficult.
12. Prepare the sponges for use.
- a. Open the betadine or alcohol and 2 X 2 gauze sponge packages.
  - b. Place them within easy reach (still in the packages).
13. Apply the constricting band with enough pressure to stop venous return without stopping the arterial flow (a radial pulse will be present).
- a. Wrap the constricting band around the limb approximately 2 inches above the selected venipuncture site.
  - b. Instruct the patient to form a fist, clench and unclench several times, and then hold the fist in a clenched position.
14. Palpate the selected vein lightly with the index finger, moving an inch or two in either direction so that the size and direction of the vein can be determined. The vein should feel like a spongy tube.

**WARNING:** Do not leave the constricting band on for more than 2 minutes.

**CAUTION:** After cleansing the skin, do not re-palpate the area.

15. Cleanse the area around the puncture site with a disinfectant soaked pad or an alcohol pad, using an outward circular motion.
16. Prepare to puncture the vein.
- a. Grasp the vacutainer unit and remove the protective needle cover.
  - b. Position the needle directly in line with the vein. Using the free hand, grasp the patient's arm below the expected point of entry.
  - c. Place the thumb of the free hand approximately 1 inch below the expected point of entry and pull the skin taut toward the hand.
17. Puncture the vein.
- a. Place the needle, bevel up, in line with the vein and pierce the skin at a 15 to 30 degree angle.
  - b. Decrease the angle until the needle is almost parallel to the skin surface. Direct it toward the vein and pierce the vein wall.

**NOTE:** A faint "give" may be felt when the vein is entered and blood will appear in the hub of the needle.

**CAUTION:** If the needle is withdrawn above the skin surface, quickly release the constricting band and stop the procedure. Begin again with a new needle.

- (1) If the venipuncture is unsuccessful, pull the needle back slightly (not above the skin surface) and attempt to pierce the vein again.
- (2) If the venipuncture is still unsuccessful, release the constricting band, place a gauze sponge lightly over the site, quickly withdraw the needle, and immediately apply pressure to the site.

(3) Notify the supervisor before attempting to enter another vein.

c. Instruct the patient to unclench the fist.

18. Collect the specimen.

a. Single specimen sample.

(1) With the dominant hand, hold the vacutainer unit and the needle steady.

**WARNING:** If the unit and needle are not held steady while pushing in the tube, the needle may either slip out of the vein or puncture the opposing vein wall.

(2) Place the index and middle fingers of the free hand behind the flange of the vacutainer and ease the tube as far forward as possible. Blood will enter the tube.

(3) After the tube is approximately two-thirds full of blood or the flow of blood stops, prepare to withdraw the needle.

b. Multiple specimen samples (multiple tubes).

(1) Follow steps 18a(1) and 18a(2) for collecting a single specimen.

(2) Remove the first tube and insert another tube into the vacutainer.

(3) Repeat this procedure until the desired number of tubes are filled or blood stops flowing.

(4) Release the constricting band using the non-dominant hand.

(5) After the last tube is approximately two-thirds full of blood or the flow stops, prepare to withdraw the needle.

**NOTE:** If the blood flow starts to slow down between samples, remove the constricting band.

19. Withdraw the needle.

**WARNING:** Never withdraw the needle prior to removing the constricting band because this will cause blood to be forced out of the venipuncture site with resulting blood loss and/or hematoma formation.

a. Release the constricting band by pulling on the long, looped end of the tubing or pulling the Velcro fasteners open.

b. Remove the specimen tube from the vacutainer.

c. Keeping the patient's arm fully extended, withdraw the needle smoothly and quickly. Immediately apply firm manual pressure over the venipuncture site with the sponge.

d. Instruct the patient to elevate the arm slightly and keep the arm fully extended. Continue to apply firm manual pressure to the site for 2 to 3 minutes.

20. Apply an adhesive bandage strip to the venipuncture site after the bleeding has stopped. Adhesive bandage strips do not take the place of pressure and therefore, are not applied until the bleeding has stopped.

21. Provide for the patient's safety and comfort.

a. Remove the protective pad.

b. Assist the patient to assume a comfortable position.

22. Dispose of and/or store the equipment IAW local SOP.



23. Remove the gloves.
24. Perform a patient care handwash.
25. Complete the laboratory request IAW local SOP.
  - a. Patient identification.
  - b. Requesting medical officer's name.
  - c. Ward number or clinic.
  - d. Date and time of specimen collection.
  - e. Test(s) requested.
  - f. Specimen source-blood.
  - g. Remarks. Write in the admission diagnosis or the type of surgery in this section.
  - h. Complete the "urgency" box. (Routine, today, preop, STAT, or ASAP.)
26. Forward the specimen to the laboratory.
  - a. Attach the lab request to the specimen tube(s) with a rubber band or paper clip.
  - b. Arrange for the specimen to be sent to the lab or transport the specimen to the lab IAW local SOP.
27. Perform a patient care handwash.
28. Record the procedure on the appropriate form.

**Evaluation Preparation:**

Setup: Use a simulated patient or another Soldier to obtain a blood specimen. Supervise closely.

Brief Soldier: Tell Soldier to obtain a blood specimen.

**Performance Measures**

	GO	NO GO
1 Verified the the medical officer's order to obtain a blood specimen.	_____	_____
2 Selected the proper blood specimen tube for the ordered test.	_____	_____
3 Labeled the blood specimen tube IAW local SOP.	_____	_____
4 Performed a patient care hand-wash.	_____	_____
5 Put on gloves.	_____	_____
6 Assembled the vacutainer unit, needle, and blood specimen tube.	_____	_____
7 Identified the patient.	_____	_____
8 Explained the procedure and purpose for collecting the blood.	_____	_____
9 Positioned the patient.	_____	_____
10 Exposed the venipuncture site.	_____	_____
11 Selected and palpated the vein.	_____	_____
12 Prepared sponges for use.	_____	_____
13 Applied the constricting band.	_____	_____

<b>Performance Measures</b>	GO	NO GO
14 Palpated the selected vein.	_____	_____
15 Cleansed the area around the venipuncture site.	_____	_____
16 Prepared to puncture the vein.	_____	_____
17 Punctured the vein.	_____	_____
18 Collected the specimen.	_____	_____
19 Withdrew the needle.	_____	_____
20 Applied an adhesive bandage strip to the site.	_____	_____
21 Provided for the patient's safety and comfort.	_____	_____
22 Disposed of and/or stored equipment IAW local SOP.	_____	_____
23 Removed the gloves.	_____	_____
24 Performed a patient care hand-wash.	_____	_____
25 Completed the laboratory request IAW local SOP.	_____	_____
26 Forwarded the specimen to the laboratory.	_____	_____
27 Performed a patient care handwash.	_____	_____
28 Recorded the procedure on the appropriate form.	_____	_____

**Evaluation Guidance:** Score each Soldier according to the performance measures. Unless otherwise stated in the task summary, the Soldier must pass all performance measures to be scored GO. If the Soldier fails any steps, show what was done wrong and how to do it correctly.

**References**

**Required**  
None

**Related**  
None

## Initiate an Intravenous Infusion

**081-833-0033**

**Conditions:** You have a patient requiring an intravenous infusion. You will need an IV administration set, IV solution, catheter-over-needle, constricting band, antiseptic sponges, 2 x 2 gauze sponges, tape, Tegaderm, IV stand or substitute, arm-board, eye protection, sharps container and disposable gloves (non-latex). You have performed a patient care hand wash and are not in a CBRN environment.

**Standards:** Initiate an IV without causing further injury to the patient.

### Performance Steps

1. Identify the patient and explain the procedure.

*NOTE:* Ascertain whether the patient is left or right-handed.

- a. Ask the patient's name and date of birth.
  - b. Check the identification band against the patient's chart, as appropriate.
  - c. Explain the reason for IV therapy.
  - d. Explain the procedure and caution the patient against manipulating the equipment.
  - e. Ask about any known allergies to such things as antiseptic sponges, (alcohol, iodine, povidone-iodine or chlorhexidine) or medication.
2. Select and inspect the equipment for defects, expiration date, and contamination.
    - a. IV fluid of choice (check medical officer's order). Discard containers that have cracks, scratches, leaks, sedimentation, condensation, or fluid which is not crystal clear and colorless.
    - b. IV injection set.
      - (1) Spike, drip chamber, tubing, and needle adapter. Discard them if there are cracks or holes or if any discoloration is present.
      - (2) Flow regulator. Inspect the flow regulator and ensure that it tightens.
      - (3) Catheter-over-needle. Discard them if they are flawed with barbs or nicks.

*NOTE:* Place stand to the side of the patient and close to the IV site.

3. Prepare the equipment.
  - a. Move the flow regulator 6 to 8 inches below the drip chamber and tighten/close it.

**CAUTION:** Do not touch the spike or the outlet of the IV container.

- b. Remove the protective covers from the spike and from the outlet of the IV container.
- c. Push the spike firmly into the container's outlet tube.
- d. Hang the container at least 2 feet above the level of the patient's heart, if possible.

*NOTE:* An IV bag container may be placed under the patient's body if there is no way to hang it. You must completely fill the drip chamber if you place it under the patient's body to prevent air from entering the tubing.

- e. Squeeze the drip chamber until it is half full of the IV fluid.
- f. Prime the tubing.

*NOTE:* Ensure that all air is expelled from the tubing.

- (1) Hold the tubing above the level of the bottom of the container.

- (2) Loosen the protective cover from the needle adapter to allow the air to escape.
- (3) Release the clamp on the tubing.
- (4) Gradually lower the tubing until the solution reaches the end of the needle adapter.
- (5) Tighten the flow regulator to stop the flow of IV fluids.
- (6) Retighten the needle adapter's protective cover.
- (7) Loop the tubing over the IV stand or holder.

g. Cut several pieces of tape and hang them in a readily accessible place.

4. Select the infusion site.

- a. Put on gloves for body substance isolation.
- b. Choose the most distal and accessible vein of an uninjured arm or hand.
- c. Avoid sites over joints.
- d. Avoid veins in infected, injured, or irritated areas.

**CAUTION:** Do not use an arm that may require an operative procedure.

- e. Use the non-dominant hand or arm, whenever possible.
- f. Select a vein large enough to accommodate the size of needle/catheter to be used.

5. Prepare the infusion site.

- a. Apply the constricting band.

*NOTE:* When applying the constricting band, use soft-walled tubing about 18 inches in length.

(1) Place the tubing around the limb, about 2 inches above the site of venipuncture. Hold one end so that it is longer than the other, and form a loop with the longer end.

- (2) Pass the looped end under the shorter end of the constricting band.

*NOTE:* When placing the constricting band, ensure that the tails of the tubing are turned away from the proposed site of venipuncture.

(3) Apply the constricting band tight enough to stop venous flow but not so tightly that the radial pulse cannot be felt.

**CAUTION:** Do not leave the constricting band in place for more than 2 minutes.

- (4) Tell the patient to open and close his fist several times to increase circulation.

- b. Select a prominent vein.
- c. Tell the patient to close his fist and keep it closed until instructed to open the fist.
- d. Clean the skin over the selected area with 70% alcohol or betadine, using a firm circular motion from the center outward.
- e. Allow the skin to dry and discard the gauze.

6. Prepare to puncture the vein.

- a. Pick up the assembled needle and remove the protective cover with the other hand.

- (1) Ensure the needle is bevel up.

(2) Place the forefinger on the needle hub to guide it during insertion through the skin and into the vein.

b. Position yourself so as to have a direct line of vision along the axis of the vein to be entered.

**CAUTION:** Keep the needle at the same angle to prevent through-and-through penetration of the vein walls.

7. Puncture the vein.

*NOTE:* You may position the needle directly above the vein or slightly to one side of the vein.

a. Draw the skin below the cleaned area downward to hold the skin taut over the site of venipuncture.

b. Position the needle point, bevel up, parallel to the vein and about 1/2 inch below the site of venipuncture.

c. Hold the needle at a 20 to 30 degree angle and insert it through the skin.

d. Decrease the angle of the needle until it is almost parallel to the skin surface and direct it toward the vein. Always hold the catheter by the clear plastic flashback chamber and not by the colored hub.

e. Advance the catheter approximately 1/4 to 1/2 inch (0.5 to 1.5 cm) into the vein.

8. Confirm the puncture.

*NOTE:* A faint "give" will be felt as the needle enters the lumen of the vein.

a. Check for blood in the flash chamber. If successful, proceed to step 9.

b. If the venipuncture is unsuccessful, pull the needle back slightly (not above the skin surface) and attempt to pierce the vein again.

c. If the venipuncture is still unsuccessful, release the constricting band and tell the patient to open and relax his clenched fist.

(1) Place a sponge lightly over the site and quickly withdraw the needle.

(2) Immediately apply pressure to the site.

d. Notify your supervisor before attempting a venipuncture at another site.

9. Advance the catheter-over-needle.

a. Grasp the hub and with a slight twisting motion fully advance the catheter.

b. While continuing to hold the hub, press lightly on the skin over the catheter tip with the fingers of the other hand.

c. Remove the needle from inside the catheter and place it in the sharps container.

**WARNING:** Do not allow air to enter the blood stream.

10. Remove the protective cover from the needle adapter on the tubing. Quickly and tightly connect the adapter to the catheter or needle hub.

11. Tell the patient to unclench the fist, and then release the constricting band.

12. Loosen the flow regulator and adjust the flow rate to keep the vein open (KVO) or to keep open (TKO) .

*NOTE:* A rate of about 30 cc per hour, or 7 to 10 drops per minute using standard drip tubing, is adequate to keep the vein open.

13. Check the site for infiltration. If it is painful, swollen, red, cool to the touch, or if fluid is leaking from the site, stop the infusion immediately.

14. Secure the site IAW local SOP.

a. Apply a sterile dressing over the puncture site, leaving the hub and tubing connection visible.

b. Loop the IV tubing onto the extremity and secure the loop with tape.

c. Splint the arm loosely on a padded splint, if necessary, to reduce movement.

15. Readjust the flow rate.

a. Determine the total time over which the patient is to receive the dosage.

*NOTE:* Example: The patient is to receive the dosage over a 3 hour period.

b. Determine the total IV dosage the patient is to receive by checking the medical officer's orders.

*NOTE:* Example: The patient is to receive 1000 cc of IV fluid.

c. Check the IV tubing package to determine the number of drops of IV fluid per cc the set has been designed to deliver.

*NOTE:* Example: The set is designed to give 10 drops of IV fluid per cc (10 gtts/cc).

d. Multiply the total hours (step 15a) by 60 minutes to determine the total minutes over which the IV dosage is to be administered.

*NOTE:* Example: 3 hours X 60 min = 180 min.

e. Divide the total IV dosage (step 15b) by the total minutes over which the IV dosage is to be administered (step 15d) to determine the cc of fluid to be administered per minute.

f. Multiply the cc/min (step 15e) by the number of drops of IV fluid per cc delivered by the tubing (step 15c) to determine the number of drops per minute to be administered.

16. Prepare and place the appropriate label.

a. Dressing.

(1) Print the information on a piece of tape.

(a) Date and time the IV was started.

(b) Initials of the person initiating the IV.

(2) Secure the tape to the dressing.

b. IV solution container.

(1) Print the information on a piece of tape.

(a) Patient's identification.

(b) Drip rate.

(c) Date and time the IV infusion was initiated.

(d) Initials of the person initiating the IV.

(2) Secure the tape to the IV container.

- c. IV tubing.
  - (1) Wrap a strip of tape around the tubing, leaving a tab.
  - (2) Print the date and time the tubing was put in place and the initials of the person initiating the IV.
- 17. Recheck the site for infiltration.
- 18. Perform a patient care handwash.
- 19. Record the procedure on the appropriate form.
  - a. Date and time the IV infusion was initiated.
  - b. Type and amount of IV solution initiated.
  - c. Drip rate and total volume to be infused.
  - d. Type and gauge of needle or cannula.
  - e. Location of the infusion site.
  - f. Patient's condition.
  - g. Name of the person initiating the IV.
- 20. Do not violate aseptic technique or cause further injury to the patient.

**Evaluation Preparation:** None.

<b>Performance Measures</b>	GO	NO GO
1 Identify the patient and explain the procedure.	_____	_____
2 Inspected the equipment.	_____	_____
3 Prepared the equipment.	_____	_____
4 Selected the infusion site.	_____	_____
5 Prepared the infusion site.	_____	_____
6 Prepared to puncture the vein.	_____	_____
7 Punctured the vein.	_____	_____
8 Confirmed the puncture.	_____	_____
9 Advanced the catheter.	_____	_____
10 Connected the adapter to the catheter hub.	_____	_____
11 Released the constricting band.	_____	_____
12 Loosened the flow regulator and adjusted the flow rate TKO.	_____	_____
13 Checked the site for infiltration.	_____	_____
14 Secured the site.	_____	_____
15 Readjusted the flow rate.	_____	_____
16 Prepared and placed the appropriate labels.	_____	_____
17 Rechecked the site for infiltration.	_____	_____

**Performance Measures**

GO            NO GO

- |    |   |       |       |
|----|---|-------|-------|
| 18 | Performed a patient care handwash.  | _____ | _____ |
| 19 | Recorded the procedure on the appropriate form.                           | _____ | _____ |
| 20 | Did not violate aseptic technique or cause further injury to the patient. | _____ | _____ |

**Evaluation Guidance:** Score each Soldier according to the performance measures. Unless otherwise stated in the task summary, the Soldier must pass all performance measures to be scored GO. If the Soldier fails any steps, show what was done wrong and how to do it correctly.

**References**

**Required**

None

**Related**

None



## Manage an Intravenous Infusion

081-833-0034

**Conditions:** You have a patient who requires intravenous (IV) infusion maintenance. You will need Tegaderm®/dressings, antiseptic swabs, sterile gauze, IV administration set, IV solution, tape, exam gloves, and DD Form 792 (Nursing Service-Twenty-Four Hour Patient Intake and Output Worksheet (I/O)). You have performed a patient care hand wash and you are not in a CBRN environment.

**Standards:** Properly manage a patient with an IV infusion, without causing further injury to the patient.

### Performance Steps

1. Assess for signs and symptoms of IV therapy complications.
  - a. Infiltration is an accumulation of fluids in the tissue surrounding an IV needle site. It is caused by penetration of the vein wall by the needle/catheter or later dislodgement of the catheter.
    - (1) Solution flows sluggishly or not at all.
    - (2) Discoloration or cool feeling around the infusion site.
    - (3) Swollen extremity.
    - (4) Fluid leaking from the infusion site.
    - (5) Patient complains of pain, tenderness, irritation, or burning at the infusion site.
  - b. Phlebitis is an inflammation of the wall of the vein. It is caused by injury to the vein during puncture or from irritation to the vein caused by long term therapy, incompatible additives, or use of a vein that is too small to handle the amount or type of solution.
    - (1) Swelling, redness, and/or tenderness around the venipuncture site.
    - (2) Sluggish flow rate.
  - c. Infection is a yellowish, foul-smelling discharge (pus) from the venipuncture site.
  - d. Air embolism is the obstruction of a blood vessel by air carried via the bloodstream (usually occurring in the lungs or heart). It is caused by conditions such as air bubbles in the IV tubing, a solution container that has run dry, or disconnected IV tubing.
    - (1) Abrupt drop in blood pressure.
    - (2) Chest pain.
    - (3) Weak, rapid pulse.
    - (4) Cyanosis.
    - (5) Loss of consciousness.
  - e. Circulatory overload is an increased blood volume that is caused by excessive IV fluid infused too rapidly into the vein (over hydration).
    - (1) Elevated blood pressure.
    - (2) Distended neck veins.
    - (3) Rapid breathing, shortness of breath, tachycardia.
    - (4) Fluid intake is much greater than urine output.

2. Perform the nursing interventions for IV therapy complications.

a. Infiltration.

- (1) Stop the infusion.
- (2) Notify your supervisor.
- (3) Record observations and action taken.

b. Phlebitis.

- (1) Stop the infusion.
- (2) Report observations to your supervisor.
- (3) Record observations and actions taken.

c. Infection.

- (1) Report observations to your supervisor.
- (2) Discontinue IV.
- (3) Record observations and actions taken.

*NOTE:* Local policies may dictate a wound culture be taken to identify the specific pathogenic microorganism responsible for the infection. Do not dispose of used IV equipment unless you are sure it is not needed.

d. Air embolism.

- (1) Report observations to the medical officer or supervisor.
- (2) Immediately place patient on left side with feet elevated to allow the pulmonary artery to absorb small air bubbles.
- (3) Administer oxygen. (See task 081-833-0158.)
- (4) Record observations and actions taken.

e. Circulatory overload.

- (1) Slow the infusion rate to keep vein open (KVO).
- (2) Place the patient in the semi-Fowler's position.
- (3) Notify the medical officer or supervisor.
- (4) Record observations and actions taken.

f. Preventive measures-frequently check flow rate to maintain desired rate.

3. Document the IV therapy.

a. Frequency.

- (1) When the IV is initiated.
- (2) Each time any part of the IV equipment is changed.

b. Label the dressing.

- (1) Cut adhesive tape and place it on a flat surface.

*NOTE:* Never write on the tape after it has been placed on the dressing.

- (2) Record the information on the piece of tape.

- (a) The gauge of the catheter.
  - (b) The time and date the dressing was applied.
  - (c) Your initials.
  - (3) Place the labeled tape over the dressing.
  - c. Label the solution container.
    - (1) Cut adhesive tape and place it on a flat surface.
    - (2) Record the information on the piece of tape.
      - (a) The patient's name.
      - (b) The patient's identification number and room/ward number, as appropriate.
      - (c) The infusion rate.
      - (d) The time and date the solution container was hung.
      - (e) Your initials.
    - (3) Place the label on the solution container.
    - (4) Prepare the timing label.
      - (a) Place a strip of adhesive tape vertically along the length of the solution container.
      - (b) Determine how long the solution container will last. (See task 081-833-0033.)
      - (c) Write on the tape the approximate times at which the solution level will reach the volume markings on the solution container.
      - (d) At the bottom of the label write the approximate time the solution container will be empty.
  - d. Label the tubing.
    - (1) Place a strip of adhesive tape around the tubing, leaving a tab.
    - (2) Write on the tab the date and time the tubing was changed.
  - e. Record the information on the appropriate forms (i.e., Nursing Notes/Field Medical Card).
    - (1) The date and time the IV was initiated.
    - (2) The amount and type of solution.
    - (3) The infusion rate.
    - (4) The type and gauge of the catheter.
    - (5) The insertion site.
    - (6) The patient's condition.
    - (7) Your name.
  - f. Record the amount of infusion on DD Form 792, if applicable.
4. Replace the solution container (only).
- NOTE:* Change the solution container every 24 hours when running a slow infusion in which the container may not be depleted in 24 hours.
- a. Perform a patient care handwash.

- b. Select or prepare the new solution. (See task 081-833-0033.)
- c. Tighten the flow regulator and stop the infusion flow.
- d. Remove the used container from the IV hanger.
- e. Remove the spike from the used container.

**CAUTION:** The old tubing is still connected to the catheter. Use care to maintain sterility. To prevent back flow of blood, keep the spike end of the tubing elevated.

- f. Insert the IV spike into a new IV container.
- g. Hang the new container.
- h. Adjust the infusion rate.
- i. Label the solution container and prepare a timing label.
- j. Record the amount of solution received from the previous container, and the time, type, and amount of new solution.

5. Change the dressing.

**NOTE:** Change the dressing every 48 hours or IAW local SOP.

- a. Perform a patient care handwash.
- b. Remove the tape and the old dressing without dislodging the catheter.

**NOTE:** Tubing should remain taped in place to reduce the chance of accidental dislodgement of the catheter or needle.

- c. Clean the area around the infusion site IAW local SOP.
- d. Examine the site for infiltration.
- e. Cover the infusion site with sterile gauze and secure with tape, or dress IAW local SOP.
- f. Secure the dressing to the site without encircling the wrist or arm.
- g. Label the dressing.

6. Replace the solution container and tubing.

**NOTE:** Change the tubing every 48 hours or IAW local SOP. Time the tubing change to coincide with the time the solution will be changed.

- a. Perform a patient care handwash.
- b. Tighten the flow regulator 6-8 inches below the drip chamber.
- c. Spike the new tubing into a new solution container and hang it from the IV pole.
- d. Fill the drip chamber 1/2 full and prime the tubing/bleed air from the IV line.

**WARNING:** Wear gloves for self-protection against transmission of contaminants whenever handling body fluids.

- e. Connect the new tubing to the needle hub.
  - (1) Loosen the tape on the old tubing without dislodging the catheter and needle.
  - (2) Place a sterile gauze pad under the catheter or needle hub to provide a small sterile field for the needle hub.
  - (3) Grasp the new tubing between the fingers of one hand.

(4) Grasp the catheter or needle hub with a sterile gauze pad between the thumb and index finger and carefully disconnect the old adapter.

(5) Press the fingers over the catheter to help prevent dislodgement and backflow of blood.

**CAUTION:** Do not remove the protective cap with your teeth.

(6) Remove the protective cap from the new tubing adapter and quickly connect it to the catheter hub.

(7) Remove the pressure over the catheter tip.

(8) Remove the gauze pad from under the catheter hub and clean the site, if necessary.

(9) Secure the tubing to the arm and reinforce the dressing, as necessary.

(10) Adjust the infusion rate.

7. Discontinue the infusion.

a. Perform a patient care handwash.

b. Put on exam gloves.

c. Tighten the flow regulator on the IV tubing to stop the infusion.

d. Remove the tape and dressing without dislodging the needle and catheter.

e. Place a sterile gauze pad over the injection site.

**WARNING:** Do not twist, raise, or lower the needle.

f. Smoothly pull out the catheter, following the course of the vein.

g. Apply pressure to the site with the gauze.

h. Examine the catheter to ensure that it was removed intact.

i. Apply an adhesive bandage to the site, if necessary.

j. Dispose of the used equipment IAW local SOP.

8. Record the procedure on the appropriate form.

**NOTE:** Ensure that the fluids received have been recorded on the appropriate form(s).

9. Do not violate aseptic technique or cause further injury to the patient.

**Evaluation Preparation:**

Setup: If the performance of this task must be simulated for training or evaluation, assemble the IV materials and equipment as indicated in task 081-833-0033. It is not necessary to have the catheter or needle inserted into a person. A simulated arm or other material may be used.

Brief Soldier: Tell the Soldier to manage a patient with an intravenous infusion.

<b>Performance Measures</b>	GO	NO GO
1 Assessed for signs and symptoms of IV therapy complications.	_____	_____
2 Performed the nursing interventions for IV therapy complications.	_____	_____
3 Documented the IV therapy.	_____	_____
4 Replaced the solution container, as necessary.	_____	_____

**Performance Measures**

GO            NO GO

- |   |   |       |       |
|---|---|-------|-------|
| 5 | Changed the dressing, as required.  | _____ | _____ |
| 6 | Replaced the solution container and tubing, as necessary.                 | _____ | _____ |
| 7 | Discontinued the infusion, as required.                                   | _____ | _____ |
| 8 | Recorded the procedure on the appropriate form.                           | _____ | _____ |
| 9 | Did not violate aseptic technique or cause further injury to the patient. | _____ | _____ |

**Evaluation Guidance:** Score each Soldier according to the performance measures. Unless otherwise stated in the task summary, the Soldier must pass all performance measures to be scored GO. If the Soldier fails any steps, show what was done wrong and how to do it correctly.

**References**

**Required**  
DD Form 792

**Related**  
None

**Initiate a FAST 1****081-833-0185**

**Conditions:** You have a casualty who requires an intraosseous infusion. You will need a First Access for Shock and Trauma 1 (FAST 1) device, alcohol swabs, an intravenous (IV) administration set, IV solution, gloves and DD Form 1380 US Field Medical Card (FMC) or a DA Form 7656 Tactical Combat Casualty Care (TCCC) Card. You are not in a CBRN environment.

**Standards:** Initiate a FAST 1 infusion without causing further injury to the casualty.

**Performance Steps**

1. Prepare the site.
    - a. Undo or cut away outer clothing to expose the sternum.
    - b. Identify the suprasternal notch.
    - c. Use aseptic technique to prepare the site.
  2. Place the target patch.
    - a. Remove the top half of the backing (labeled remove 1) from the patch.
    - b. Locate the sternal notch using your index finger.
    - c. Holding your index finger perpendicular to the sternum, align the locating notch in the target patch with the sternal notch, keeping your index finger perpendicular.
    - d. Verify that the target zone (circular hole) on the patch is directly over the casualty's midline.
    - e. Secure the top half of the patch to the body by pressing firmly downward on the patch, engaging the adhesive.
    - f. Remove the remaining backing (labeled remove 2) and secure patch to the casualty.
    - g. Verify correct patch placement by checking the alignment of the locating notch with the casualty's sternal notch and making sure the target zone is over the midline of the casualty's body.
  3. Insert the introducer.
    - a. Remove sharps cap from the introducer.
    - b. Place the bone probe cluster needles in the target zone of the target patch, and ensure that all the bone probe needles are within the target zone.
    - c. Hold the introducer perpendicular to the sternum of the casualty to ensure proper functioning of the depth-control mechanism.
- WARNING:** Apply the force perpendicular to the skin and along the long axis of the introducer. Avoid extreme force, twisting and jabbing motions.
- d. Pressing straight along the introducer axis, with hand and elbow in line, push with firm constant force until a distinct release is heard and felt.
  - e. After the release, expose the infusion tube by gently withdrawing the introducer along the same path used to insert it (perpendicular to the skin). The stylet supports will fall away.
  - f. Locate the orange sharps plug, and place it on a flat surface with the foam facing up. Keep both hands behind the needles, and push the bone probe cluster straight into the foam.

After the sharps plug has been engaged and the sharps are safely covered, reattach the clear sharps cap to the introducer.

g. Dispose of the introducer using contaminated sharps protocols.

4. Connect the infusion tube to the right-angle female connector on the target patch.

a. Connect syringe and flush infusion tube with 5 ml of sterile solution.

**NOTE:** This connection is a slip luer.

b. Connect IV infusion tubing and open IV line to introduce fluids.

5. Secure the protector dome.

a. Place the protector dome directly over the target patch and press down firmly to engage the Velcro fastening. Ensure that the infusion tubing and the right angle female connector are contained under the dome.

b. The dome can be removed by holding the patch against the skin and peeling back the dome Velcro®.

**WARNING:** The remover package must be transported with the casualty. It will be used later to remove the FAST 1 system.

**CAUTION:** Do not breach the packaging since the remover is sterile.

6. Attach the remover package, if contained in system to the casualty for transport.

7. Record all treatment on the FMC or TCCC Card.

**Evaluation Preparation:** None.

<b>Performance Measures</b>	GO	NO GO
1 Prepared the site.	_____	_____
2 Placed target patch at landmark.	_____	_____
3 Inserted the introducer.	_____	_____
4 Connected the infusion tube to the right angle connector on the target patch.	_____	_____
5 Attached the protective dome to target patch.	_____	_____
6 Attached and shipped the remover with the casualty, if applicable.	_____	_____
7 Recorded all treatment on the FMC or the TCCC Card.	_____	_____

**Evaluation Guidance:** Score each Soldier according to the performance measures. Unless otherwise states in the task summary, the Soldier must pass all performance measures to be scored GO. If the Soldier fails any steps, show what was done wrong and how to do it correctly.

**References**

**Required**  
 DA Form 7656  
 DD Form 1380

**Related**  
 None



## Initiate a Saline Lock

081-835-3025

**Conditions:** You have a patient requiring a saline lock. You will need 18 gauge IV catheter/needles, 21 gauge 1 1/4 inch needle, saline lock adapter plug, constricting band, tape, 4 inch Tegaderm® bandage, alcohol and Betadine® swabs, 5 cc syringe, a container of IV solution with primed tubing, sharps container, gloves disposable (non-latex), pen and DD Form 1380 US Field Medical Card (FMC). You are not in a CBRN environment.

**Standards:** Establish a saline lock without causing further injury to the patient.

### Performance Steps

1. Prepare to establish a saline lock.
  - a. Assemble the necessary equipment.
    - (1) Two 18 gauge IV catheter/needles.
    - (2) One 21 gauge 1 1/4 inch needle.
    - (3) Saline lock adapter plug.
    - (4) Constricting band.
    - (5) 4 inch Tegaderm® bandage.
    - (6) Alcohol and Betadine® swabs.
    - (7) 5 cc syringe.
  - b. Explain the procedure and the purpose of the saline lock to the patient. Ask about allergies.
  - c. Place the patient in a comfortable position with the arms supported.
  - d. Select the catheter insertion site.
  - e. Prepare the insertion site. Apply a constricting band 2 inch above the venipuncture site - tight enough to stop venous flow, but not so tight that the radial pulse cannot be felt.
  - f. Clean the skin with either an alcohol swab or a Betadine® swab in a circular motion from the center outward.
  - g. Allow area to air dry.
2. Insert the saline lock.
  - a. Put on gloves.
  - b. Perform the venipuncture. Hold the catheter with your dominant hand and remove the protective cover without contaminating the needle. Hold the flash chamber with the thumb and forefinger directly above the vein. Draw skin below the cleansed site downward to hold the skin taut over the site of the venipuncture with your non-dominant hand.
  - c. Position the needle point, bevel up, parallel to the vein and about 1/2 inch below the venipuncture site. Continue advancing the needle/catheter until the vein is pierced.
  - d. When "flash" of blood enters the flash chamber, decrease the angle between the skin and needle until the angle is almost parallel to the skin, and advance further to secure catheter placement in the vein.
  - e. Advance the catheter approximately 1/4 to 1/2 (0.5 to 1.5 cm) into the vein.

f. Pull back on the needle to separate needle from catheter about 1/4 inch and advance the catheter into the vein.

g. Release the constricting band with your non-dominant hand, then place pressure on the vein above the insertion site by pressing with the little finger of non-dominant hand while thumb and index fingers grasp hub of catheter to stabilize.

h. Remove the needle after advancing the plastic catheter into the vein.

i. Quickly uncap and insert the male end of the saline lock adapter plug into the hub of the catheter.

j. Apply a Tegaderm® dressing to the site, covering 100% of the site to include insertion site and saline lock adapter plug.

k. Flush the IV catheter. Stabilize saline lock device covered by Tegaderm® with non-dominant hand and cleanse the rubber diaphragm covered by the transparent dressing with alcohol swab with dominant hand. Using the 21 gauge needle and 5 cc syringe filled with sterile fluid, penetrate the transparent dressing and insert the needle into the saline lock. Aspirate the syringe to check for blood return. Inject 5 cc of sterile fluid into the IV catheter, looking for signs of infiltration.

3. Initiate fluids through a saline lock.

a. Assemble the necessary equipment—a container of IV solution with primed tubing.

b. Explain the procedure to the patient. Ask about allergies.

c. Put on gloves.

d. Stabilize saline lock device covered by Tegaderm® with non-dominant hand and cleanse the rubber diaphragm covered by the transparent dressing with an alcohol swab. Introduce the 18 gauge catheter through the Tegaderm® dressing and saline lock until the catheter hub is against the saline lock.

e. Apply pressure to the vein above the insertion site and withdraw the needle from the catheter and discard it.

f. Attach the primed IV tubing and initiate the flow of IV fluid through the catheter into the saline lock, checking for signs of infiltration.

g. Secure the IV tubing to the patient's arm. Unroll approximately 2 inches of tape from the roll, and place it under the IV tubing with the sticky side up.

h. Fold the tape back over the tubing and onto itself, and then completely around the patient's arm until it crosses back over the tubing.

4. Document the procedure and observations on the FMC.

a. Type and size of needle inserted.

b. Location of the saline lock.

c. Date and time of insertion.

d. Date and time an existing IV was converted to a saline lock.

e. An assessment of the condition of the venipuncture site.

f. Date and time the saline lock was converted to a continuous infusion IV and the type and amount of IV solution hung.

**Evaluation Preparation:** None.

<b>Performance Measures</b>	GO	NO GO
1 Prepared to establish a saline lock.	_____	_____
2 Established a saline lock.	_____	_____
3 Initiated fluids through saline lock.	_____	_____
4 Documented all procedures on the FMC.	_____	_____

**Evaluation Guidance:** Score each Soldier according to the performance measures. Unless otherwise stated in the task summary, the Soldier must pass all performance measures to be scored GO. If the Soldier fails any steps, show what was done wrong and how to do it correctly.

**References**

**Required**  
DD Form 1380

**Related**  
None

## Discontinue an Intravenous Infusion

081-833-0235

**Conditions:** You have a patient that requires their intravenous infusion be discontinued. You will need disposable gloves, alcohol or povidone iodine wipes, scissors, sterile 2 x 2 gauze, an adhesive bandage, waterproof pad (chux), pen, puncture resistant (sharps) container, a container for contaminated bloody waste and an SF 510 Nursing Notes. You have verified the medical officer's order and the patient, performed a patient care handwash and are not in a CBRN environment.

**Standards:** Discontinue an intravenous infusion without causing injury to the patient.

### Performance Steps

1. Explain the procedure to patient.
2. Position the patient in a position of comfort and provide privacy.
3. Stop the intravenous (IV) infusion, (clamp off infusion tubing).
4. Place chux under extremity where IV infusion site is located.
5. Open 2 x 2 gauze or adhesive bandage, (peel back top cover), and place in area within reach.

**NOTE:** Use aseptic technique when opening 2 x 2 gauze or adhesive bandage.

6. Put on disposable gloves.
7. Remove the tape and arm board from the extremity.
8. Remove the dressing covering the insertion site.

**CAUTION:** Careless dislodgement of the catheter may cause bleeding and bruising.

9. Loosen the tape around the catheter and administration set tubing.
10. Take 2 x 2 out of the wrapper and fold it into fours to create a pressure dressing.
11. Hold the folded gauze lightly over the insertion site continuing to use your non-dominant hand.

**CAUTION:** If the needle or catheter appears to have broken off, do not discard it. Notify your medical officer immediately of this potentially serious complication.

12. Remove the needle or catheter quickly and carefully with your dominant hand.
13. Place the needle or catheter on chux pad, keeping in eyesight at all times.
14. Apply pressure to the site immediately and hold until bleeding stops.

**NOTE:** Adult patients can also perform this task of holding pressure if you ask them.

**WARNING:** Before cleansing area, be sure to ask the patient about allergies to povidone-iodine.

15. Cleanse the area with alcohol or povidone-iodine.
16. Cover the insertion site with an adhesive bandage.

**NOTE:** The adhesive bandage should not be applied until all bleeding has stopped to minimize the possibility of prolonged or unnoticed bleeding.

17. Discard the needle or catheter in a puncture-resistant (sharps) container.

- 18. Discard other supplies contaminated by blood or body fluids in the contaminated container.
- 19. Discard any unused portion of IV fluid in the sink.
  - a. Cut port on bag and allow fluid to drain into sink.
  - b. Note the amount of fluid that is left in the bag.
- 20. Discard the empty IV solution container and tubing according to facility policy.
- 21. Remove gloves and perform a patient care handwash.
- 22. Record procedure and patient's tolerance on SF 510.
  - a. Note the amount of fluid patient received.
  - b. Note the amount of fluid left in the container.
  - c. Note if the needle or catheter was intact upon removal.
  - d. Note what the site looked like and if there were any signs and symptoms (s/s) of infiltration.

**Evaluation Preparation:**

Setup: For training and evaluation, use an IV arm that has an IV already started.

Brief Soldier: Tell the Soldier the IV needs to be discontinued.

<b>Performance Measures</b>	<b>GO</b>	<b>NO GO</b>
1 Explained the procedure to the patient.	_____	_____
2 Positioned patient in a position of comfort and provided privacy.	_____	_____
3 Stopped the intravenous infusion, (clamped off the tubing).	_____	_____
4 Placed chux under extremity where IV infusion site is located.	_____	_____
5 Opened 2 x 2 gauze or adhesive bandage, (peeled back top cover), and placed in area within reach.	_____	_____
6 Put on disposable gloves.	_____	_____
7 Removed the tape and arm board from the extremity.	_____	_____
8 Removed the dressing covering the insertion site.	_____	_____
9 Loosened the tape around the catheter and administration set tubing.	_____	_____
10 Took 2 x 2 gauze or adhesive bandage out of wrapper and folded it into fours like a pressure dressing.	_____	_____
11 Held the 2 x 2 or adhesive bandage lightly over the insertion site using non-dominant hand.	_____	_____
12 Removed the needle or catheter quickly and carefully with your dominant hand.	_____	_____
13 Placed the needle or catheter on chux pad keeping it within eyesight at all times.	_____	_____
14 Applied pressure to the site immediately and held until bleeding stopped.	_____	_____

<b>Performance Measures</b>	GO	NO GO
15 Cleansed the area with alcohol or povidone-iodine.	_____	_____
16 Covered the insertion site with an adhesive bandage.	_____	_____
17 Discarded the needle or catheter in a puncture resistant (sharps) container.	_____	_____
18 Discarded other supplies contaminated by blood or body fluids in the contaminated container.	_____	_____
19 Discarded the unused portion of IV fluid in the sink.	_____	_____
20 Discarded the empty IV solution container and tubing according to facility policy.	_____	_____
21 Removed gloves and performed a patient care hand wash.	_____	_____
22 Recorded procedure and patient's tolerance on SF 510.	_____	_____

**Evaluation Guidance:** Score each Soldier according to the performance measures. Unless otherwise stated in the task summary, the Soldier must pass all performance measures to be scored GO. If the Soldier fails any steps, show what was done wrong and how to do it correctly.

**References**

**Required**  
SF 510

**Related**  
None

**Subject Area 6: Primary Care**  
**Provide Treatment for Sinus Infections**

**081-833-0242**

**Conditions:** You have a patient complaining of a sinus infection. All other immediate life threats have been treated and managed. You have performed a patient care handwash and taken body substance isolation, (BSI), precautions. You will need an otoscope, disposable speculum attachments, penlight, or other light source, pen and SF 600 (Medical Record-Chronological Record of Medical Care). You are not in a CBRN environment.

**Standards:** Provide treatment for common sinus infections without causing harm to the patient.

**Performance Steps**

1. Gather equipment and supplies.
2. Identify patient and inquire about allergies.
3. Provide privacy and safety for the patient.
  - a. Place patient in position of comfort, as long as procedure permits.
  - b. Explain procedure to patient.
4. Perform an head, ears, eyes, nose and throat ( ) examination. (See task 081-833-0254.)
5. Identify the sinus disorder.
  - a. Seasonal allergies or allergic rhinitis (hay fever)—rhinitis is an inflammation of the nasal membranes.

*NOTE:* The sensitized immune system produces antibodies to these allergens, which cause chemicals called histamines to be released into the blood stream.

(1) Common causes—patients often have family history of multiple allergic disorders including hay fever, asthma and eczema.

(2) Signs and symptoms include sneezing, swelling and itching, (puritis), of the affected tissue, increased mucous production (rhinorrhea), nasal congestion, hives and rashes.

*NOTE:* Signs and symptoms are predominately in the nose and eyes.

b. Sinus Infection (sinus pain/fullness)—general term.

(1) Common causes—sinus infection may be caused by anything interfering with airflow into the sinuses and the drainage of mucous out of the sinuses.

(2) Signs and symptoms can include those generally associated with colds and allergies.

c. Acute sinusitis-inflammation/infection of the paranasal sinuses.

(1) Common causes-infection by the pathogenic microorganism. These can be bacterial, viral or an allergen.

(2) Signs and symptoms include headache, facial tenderness or pain, fever, cloudy, discolored nasal drainage, nasal stuffiness, sore throat and a cough.

6. Provide treatment for a sinus disorder.
  - a. Increase fluids.
  - b. Decongestant.
  - c. Avoid antihistamines. Antihistamines dry and thicken the nasal mucosal areas.

d. Refer to medical officer for antibiotics.

7. Document treatment on SF 600.

**Evaluation Preparation:**

Setup: For training and evaluation, use another Soldier as a simulated patient complaining of a sinus complaint.

Brief Soldier: Tell the Soldier the simulated patient has a sinus complaint that requires treatment.

<b>Performance Measures</b>	GO	NO GO
1 Gathered equipment and supplies.	_____	_____
2 Identified patient and inquired about allergies.	_____	_____
3 Provided privacy and safety for the patient.	_____	_____
4 Performed an HEENT examination.	_____	_____
5 Identified the sinus disorder.	_____	_____
6 Provided treatment for a sinus disorder.	_____	_____
7 Documented treatment on SF 600.	_____	_____

**Evaluation Guidance:** Score each Soldier according to the performance measures. Unless otherwise stated in the task summary, the Soldier must pass all performance measures to be scored GO. If the Soldier fails any steps, show what was done wrong and how to do it correctly.

**References**

**Required**  
SF 600

**Related**  
None



## Perform a HEENT Exam

**081-833-0254**

**Conditions:** You have a patient requiring a head, ears, eyes, nose and throat (HEENT) examination. All other apparent life threats have been treated and managed. You have performed a patient care handwash, taken body substance isolation (BSI) precautions. You will need an otoscope, disposable speculum attachments, tongue blades, pen light, pen, Snellen chart, and SF 600 (Medical Record-Chronological Record of Medical Care). You are not in a CBRN environment.

**Standards:** Perform an HEENT examination without causing further injury to the patient.

### Performance Steps

1. Gather equipment and supplies.
2. Identify patient and inquire about allergies.
3. Provide privacy and safety for the patient.
  - a. Place patient in a position of comfort as long as the procedure permits.
  - b. Explain procedure to the patient.
4. Perform a history and physical exam of the eyes.
  - a. Patient history.

**NOTE:** An accurate history is needed in establishing a possible cause for the eye problem.

- (1) Mechanism of injury (if there is a history of injury)?
  - (a) Blunt trauma versus penetrating injury.
  - (b) Was there a projectile or missile injury? (Glass from a motor vehicle accident.)
  - (c) Thermal, chemical or laser burn?
- (2) Does the patient wear glasses or contact lenses?
- (3) History of eye disease or previous eye trauma/surgery?
- (4) Is there eye pain or loss of vision? If there is vision loss, is it in one eye or both?

**NOTE:** Ocular injuries are classified as penetrating or non-penetrating. Eye injuries are common in spite of the protection by the bony orbit.

- b. Physical exam.

**WARNING:** In cases of ocular burns, the eyes must be flushed first. Once the mechanism of the burn has been eliminated, then a visual acuity screening is accomplished.

- (1) Inspect and palpate in adequate lighting.

**NOTE:** Avoid putting pressure on the globe while performing the exam.

- (3) Visual acuity is the most important step in evaluating ocular problems.

Have the patient:

- (a) Read any available printed material.
- (b) Count fingers.

**NOTE:** If the patient is unable to count fingers, assess their ability to detect hand motion 1 to 2 inches in front of the eye.

- (c) Distinguish between light and dark.

**CAUTION:** When equipment, light and /or space do not permit a gross vision examination is recommended as opposed to no vision exam.

(d) Read the Snellen chart (eye chart). (See task 081-833-0193.)

**NOTE:** If the patient has corrective lenses, test without glasses first, and then test with glasses on.

(3) Note any drainage or bleeding from the eye.

(4) Inspect eyelids for:

(a) Ability to open wide and close completely.

(b) Edema.

(c) Discoloration.

(d) Foreign bodies.

(e) Inspect position of the lids in relationship to the eyeballs.

(5) Inspect conjunctiva and sclera for:

**NOTE:** Ask patient to look upward as you pull the lower lid downward. Then tell the patient to look down as you pull the upper lid upward.

(a) Note color of conjunctiva, (pink to dark color is normal).

(b) Inspect for erythema or exudate.

(c) Note color of sclera (white is normal).

**NOTE:** Patient's who have darker pigmented skin may have scattered areas of brown pigments, a normal finding, but this observation should be noted.

(6) Inspect cornea (should be clear and avascular).

(7) Inspect pupil-note any irregularity in the shape of the pupils.

**NOTE:** Unequal size of pupils (anisocoria) may be congenital (approximately 20% of normal people have minor or noticeable differences in pupil size, but pupillary reaction is normal.)

(a) Pupils should be equal, round, regular and reactive to light (PERRL).

(b) Assess extra ocular movement.

(8) Test pupillary reaction to light both directly and consensually.

(a) Dim the lights in the room so that the pupils dilate.

**NOTE:** Do not shine into both eyes simultaneously.

(b) Shine a penlight directly into one eye and observe the pupil constrict.

(c) Note consensual reaction response of the opposite pupil constricting simultaneously with the tested pupil.

5. Perform a history and physical exam of the ears.

a. Patient history.

(1) Ask patient about symptoms associated with ear problems, pain, swelling, redness, drainage.

(2) Ask patient about history of recent illness, upper respiratory infection (URI), sore throat, or recent swimming.

(3) Ask patient about any hearing loss.

- (4) Ask patient if they have a fever of 101° F or greater.
- (5) Ask the patient about possible embedded foreign objects in ear.

b. Physical exam.

**NOTE:** Physical examination consists of inspection, palpation and otoscopic examination of the ear.

- (1) Examine external pinna for erythema, swelling, deformity, trauma, or drainage from canal.
- (2) Auricle—Inspect the ear size, shape, symmetry, landmarks, color, and position on the head; palpate the auricle for tenderness and swelling.
- (3) Palpate the ear and mastoid process.
- (4) External auditory canal—inspect the external auditory canal (EAC) for discharge or earwax (cerumen).

**CAUTION:** Consult with your medical officer before completing an otoscopic exam on a child.

- (5) Using otoscope inspect the EAC and middle ear.

**NOTE:** Use the largest speculum the ear canal will accommodate.

- (a) Examine the normal ear first.
- (b) Hold the otoscope handle between your thumb and fingers; brace your hand against the patient's face.
- (c) Pull the auricle back and out on an adult patient.
- (d) Visualize the canal as you insert the speculum.
- (e) Slowly insert the speculum noting discharge, lesions, narrowing of the EAC, foreign bodies, or presence of cerumen (earwax).

**NOTE:** A healthy TM or ear drum may be pearly gray to amber in color. Redness indicates infection.

6. Perform a patient history and physical exam of the nose and sinuses.

a. Patient history.

- (1) Ask about recent upper respiratory infection symptoms, drainage, bleeding, congestion, trauma, pressure, recent dental problems, and pain.
- (2) Ask about any medications, prior history or chronic illnesses.
- (3) Ask about duration of symptoms.
- (4) Ask about any allergies or family history of allergies.

b. Physical exam.

- (1) Inspect for shape, size, symmetry, color, and presence of deformities or lesions.
- (2) Palpate the external nose for tenderness, swelling or masses.
- (3) Paranasal sinuses.
  - (a) Inspect the frontal and maxillary sinus area for swelling.
  - (b) Palpate the frontal and maxillary sinuses for tenderness.

**NOTE:** Only the maxillary and frontal sinuses are accessible to physical examination.

7. Perform a patient history and physical examination of the throat.

a. Patient history.

(1) Ask patient about recent symptoms, bad breath, sore throat, hoarseness, difficulty swallowing, and inability to open mouth.

(2) Ask patient about duration of symptoms, smoking habits and drooling.

b. Physical exam.

(1) Inspect and palpate the patient's lips for symmetry, color, edema and surface abnormalities.

(2) Inspect buccal mucosa, teeth, and gums.

*NOTE:* If patient wears dentures, have them remove their dentures and then open their mouth. Gums should have a slightly stippled, pink appearance with a clearly defined, tight margin at each tooth.

(a) Have the patient to open their mouth, stick out their tongue and say "ah."

(b) Use a disposable tongue blade and bright light to inspect mucous membrane of the entire mouth, teeth, posterior pharynx and tonsils.

*NOTE:* Mucous membranes should look pinkish-red, smooth and moist. Take note of any missing teeth, cavities, ulcerations and lesions.

(3) Inspect the tongue.

*NOTE:* The tongue should appear dull red, moist and glistening; should be smooth with increasing roughness.

(4) Inspect the oropharynx.

*NOTE:* The whitish hard palate should be dome-shaped. The pinker soft palate should be continuous with the hard palate.

8. Document findings on the SF 600.

**Evaluation Preparation:**

Setup: For training and evaluation, use a another Soldier as the simulated patient.

Brief Soldier: Tell the Soldier the simulated patient requires a history and physical examination of the HEENT.

<b>Performance Measures</b>	GO	NO GO
1 Gathered equipment and supplies.	_____	_____
2 Identified patient and inquired about allergies.	_____	_____
3 Provided privacy and safety for the patient.	_____	_____
4 Performed a patient history and physical exam of the eyes.	_____	_____
5 Performed a patient history and physical exam of the ears.	_____	_____
6 Performed patient history and physical exam of the nose and sinuses.	_____	_____
7 Performed a patient history and a physical exam of the mouth and oropharynx.	_____	_____
8 Documented findings on the SF 600.	_____	_____

**Evaluation Guidance:** Score each Soldier according to the performance measures. Unless otherwise stated in the task summary, the Soldier must pass all performance measures to be scored GO. If the Soldier fails any steps, show what was done wrong and how to do it correctly.

**References**

**Required**  
SF 600

**Related**  
None

## Irrigate Eyes

**081-833-0054**

**Conditions:** You have a patient requiring eye irrigation. A visual acuity examination has been performed and documented. You have performed a patient care handwash. You will need draping materials, catch basin, light source, gauze or cotton balls, irrigating syringe or similar equipment, gloves, and irrigating solution (normal saline or water). You are not in a CBRN environment.

**Standards:** Irrigate the eyes without injuring the eyes.

### Performance Steps

1. Identify the patient and explain the procedure.

**CAUTION:** Do not irrigate an eye that has an impaled object.

2. Verify the type, strength, and expiration date of the irrigating solution in accordance with (IAW) local standard operating procedure (SOP) and medical officer's order.

3. Ask the patient to remove contact lenses or glasses, if necessary.

4. Position the patient.

- a. If lying on the back, tilt the head slightly to the side that is to be irrigated.

- b. If seated, tilt the head slightly backward and to the side that is to be irrigated.

5. Position the equipment.

- a. Drape the areas of the patient that may be splashed by the solution.

- b. Place a catch basin next to the face on the affected side.

- c. Position the light so that it does not shine directly into the patient's eyes.

**WARNING:** Wear gloves for self-protection against transmission of contaminants whenever handling body fluids.

6. Put on gloves.

7. Clean the eyelids with gauze or cotton balls, and rinse debris from the outer eye.

**CAUTION:** Do not put pressure on the eyeball.

8. Separate the eyelids using the thumb and forefinger, and hold the lids open.

9. Irrigate the eye.

- a. Hold the irrigating tip 1 to 1 1/2 inches away from the patient's eye.

- b. Direct the irrigating solution gently from the inner canthus to the outer canthus.

- c. Use only enough pressure to maintain a steady flow of solution and to dislodge any secretions or foreign bodies.

- d. Instruct the patient to look up to expose the conjunctival sac and lower surface of the eye.

- e. Instruct the patient to look down to expose the upper surface of the eye.

**CAUTION:** Do not touch the eye.

10. Dry the area around the eye by gently patting with gauze sponges.

11. Remove the gloves, and perform a patient care handwash.
12. Record the treatment given IAW local SOP.

**Evaluation Preparation:**

Setup: For training and evaluation, use another Soldier to perform an eye irrigation on.

Brief Soldier: Tell the Soldier the simulated patient requires an eye irrigation.

<b>Performance Measures</b>	GO	NO GO
1 Identified the patient and explained the procedure.	_____	_____
2 Verified the type, strength, and expiration date of the irrigating solution IAW local SOP and medical officer's order.	_____	_____
3 Asked the patient to remove contact lenses or glasses, if necessary.	_____	_____
4 Positioned the patient.	_____	_____
5 Positioned the equipment.	_____	_____
6 Put on gloves.	_____	_____
7 Cleaned the eyelids with gauze or cotton balls, and rinsed debris from the outer eye.	_____	_____
8 Separated the eyelids using the thumb and forefinger, and held the lids open.	_____	_____
9 Irrigated the eye.	_____	_____
10 Dried the area around the eye by gently patting with gauze sponges.	_____	_____
11 Removed the gloves and performed a patient care handwash.	_____	_____
12 Recorded the treatment given IAW local SOP.	_____	_____

**Evaluation Guidance:** Score each Soldier according to the performance measures. Unless otherwise stated in the task summary, the Soldier must pass all performance measures to be scored GO. If the Soldier fails any steps, show what was done wrong and how to do it correctly

**References**

**Required**  
None

**Related**  
None

## Provide Treatment for Common Eye Infections

081-833-0240

**Conditions:** You have a patient with symptoms of an eye disorder. All immediate life threats have been taken care of. You have performed a patient care handwash and taken BSI (body substance isolation) precautions. You will need a penlight, a Snellen visual acuity chart, disposable cotton-tipped applicators, pen and SF 600 (Medical Record-Chronological Record of Medical Care). You are not in a CBRN environment.

**Standards:** Provide treatment for common eye infections without causing injury to the patient.

### Performance Steps

1. Gather equipment and supplies.
2. Identify patient and inquire about allergies.
3. Provide privacy and safety for the patient.
  - a. Place patient in position of comfort, as long as procedure permits.
  - b. Explain procedure to patient.
4. Solicit patient history and perform a physical examination of the eyes. (See task 081-833-0254.)
5. Identify the common eye infection.
  - a. Conjunctivitis—inflammation of the conjunctiva.
    - (1) Common causes—a chemical irritation, infections or allergies.
    - (2) Signs and symptoms may start in one or both eyes and include:
      - (a) Grittiness, redness, burning and discharge.
      - (b) Sclera and conjunctivae are commonly reddened with a clear, watery (allergy) or purulent (bacterial) discharge.
      - (c) Allergic conjunctivitis—patient may have associated sneezing and water nasal discharge.
  - b. Red Eye.
    - (1) Common causes—red eye can be a sign or symptom of a variety of abnormalities of the eye. Infection, allergies, drugs, chemical exposure, trauma or systemic disease may cause a red eye.
    - (2) Signs and symptoms can begin in one or both eyes and include pain and redness.
6. Provide treatment for common eye infections.

**CAUTION:** Treatment of the conjunctivitis depends on the cause and must be evaluated by the medical officer.

- a. Conjunctivitis—inflammation of the conjunctiva.
  - (1) Referral to a medical officer is required in all ocular complaints.
  - (2) Eye pain with decreased visual acuity should be considered an emergency and be evaluated on an urgent basis.



b. Red Eye.

(1) Referral to a medical officer is required in all ocular complaints.

(2) Eye pain with decreased visual acuity should be considered an emergency and be evaluated on an urgent basis.

7. Document treatment on SF 600.

**Evaluation Preparation:**

Setup: For training and evaluation, use another Soldier as a simulated patient complaining of a ocular complaint.

Brief Soldier: Tell the Soldier the simulated patient has an ocular complaint that requires treatment.

<b>Performance Measures</b>	GO	NO GO
1 Gathered equipment.	_____	_____
2 Identified patient and inquired about allergies.	_____	_____
3 Provided privacy and safety for the patient.	_____	_____
4 Solicited patient history and performed a physical examination of the eyes. (See task 081-833-0254.)	_____	_____
5 Identified the common eye infection.	_____	_____
6 Provided treatment for common eye infections.	_____	_____
7 Documented treatment on SF 600.	_____	_____

**Evaluation Guidance:** Score each Soldier according to the performance measures. Unless otherwise stated in the task summary, the Soldier must pass all performance measures to be scored GO. If the Soldier fails any steps, show what was done wrong and how to do it correctly.

**References**

**Required**  
SF 600

**Related**  
None

## Provide Treatment for Common Throat Infections

081-833-0243

**Conditions:** You have a patient complaining of a sore throat. All other immediate life threats have been taken care of. You have performed a patient care handwash and taken body substance isolation, (BSI), precautions. You will need tongue blades, penlight, or other light source, pen and SF 600 (Medical Record-Chronological Record of Medical Care). You are not in a CBRN environment.

**Standards:** Provide treatment for common throat infections without causing harm to the patient.

### Performance Steps

1. Gather equipment and supplies.
2. Identify patient and inquire about allergies.
3. Provide privacy and safety for the patient.
  - a. Place patient in position of comfort as long as procedure permits.
  - b. Explain procedure to patient.
4. Perform a head, ears, eyes, nose, and throat (HEENT) examination. (See task 081-833-0254.)
5. Identify throat disorders.
  - a. Upper respiratory infection (URI) – acute infection of the upper airway.
    - (1) Common causes – URI's are usually a result of different viruses, but can be bacterial in nature.
    - (2) Signs and symptoms.
      - (a) Sore throat.
      - (b) Cough which may be either productive or non-productive.
      - (c) Sputum may be clear or purulent.
      - (d) Low-grade fever, possible.
      - (e) Nasal congestion/discharge.
      - (f) Sinus pressure.
      - (g) Appearance of a slightly reddened pharynx with mucous streaking.

**WARNING:** Streptococcal (strep) pharyngitis is spread by person-to-person contact with nasal secretions or saliva, often among family or household members.

- b. Streptococcal (strep.) pharyngitis–infection of the posterior pharynx and/or tonsils.

**NOTE:** It is most common in the late fall, winter and early spring.

- (1) Common causes–most common is Group A streptococcus bacteria.
- (2) Signs and symptoms.

**NOTE:** In some individuals, strep throat is very mild with only a few of these symptoms. In others, strep throat is severe. The onset is usually sudden.

- (a) Severe sore throat.
- (b) Fever.

- (c) Tender/swollen neck glands.
- (d) Nausea.
- (e) Malaise.
- (f) Exudate (pus) is commonly seen on reddened tonsils and pharynx.
- (g) Headache.
- (h) Chills.

c. Peri-tonsillar abscess (PTA)—bacterial infection of the tonsils, which spreads into a cellulitis and abscess.

- (1) Common causes—usually results as a complication of “strep” pharyngitis.
- (2) Signs and symptoms.

**CAUTION:** An abscess is a collection of pus that forms near an area of infected skin or to the soft tissue. The abscess can cause pain, swelling, and may block the throat.

(a) The abscess usually affects one side of the mouth resulting in a tonsil deviating toward the midline.

*NOTE:* A peri-tonsillar abscess forms in the throat tissues next to one of the tonsils.

- (b) Ear pain on the same side as the abscess.
- (c) Severe sore throat that is isolated to one side.
- (d) Spasm in the muscles of the jaw or trismus (difficulty in opening the mouth).
- (e) Difficulty swallowing saliva.
- (f) Muffled voice, often described as a “hot potato” voice (sounds as if you have a mouthful of hot potato when you talk).
- (g) Fever may be present.
- (h) Chills.

d. Infectious mononucleosis—a viral infection that presents as a sore throat.

- (1) Common cause—viral.
- (2) Signs and symptoms.
  - (a) Lymph node (gland) enlargement of the neck.
  - (b) Shaggy, white-purple tonsillar exudate.
  - (c) Abdominal pain may indicate inflammation of the spleen.

6. Provide treatment.

a. Upper respiratory infection (URI).

- (1) Referral to medical officer (MO).
- (2) A cough suppressant, decongestant, throat lozenges and analgesic for fever and body aches will be prescribed.

*NOTE:* Antibiotics are not indicated for URIs.

- b. Streptococcal (strep.) pharyngitis.
  - (1) Referral to MO.

**NOTE:** Diagnosis is confirmed with a throat culture however the MO may treat for this condition based on symptoms alone.

(2) Antibiotics will be prescribed by the MO; penicillin has been traditionally recommended and is still very effective.

**CAUTION:** Even though the sore throat usually gets better on its own, individuals who have strep throat must take antibiotics to prevent more serious complications of this infection, including rheumatic fever.

c. Peri-tonsillar abscess (PTA).

**WARNING:** This is a surgical emergency.

(1) Referral to MO immediately.

(2) Peri-tonsillar abscesses require urgent surgical drainage and antibiotic therapy.

d. Infectious mononucleosis.

(1) Referral to MO.

**CAUTION:** Patients are advised to avoid contact sports (football, etc.) for at least 30 days after diagnosis due to the increased risk of splenic rupture (rupture of the spleen).

(2) The MO will may order a blood test (Monospot) along with a throat culture to rule out “strep” and confirm mononucleosis.

7. Document treatment on SF 600.

**Evaluation Preparation:**

Setup: For training and evaluation, use another Soldier as a simulated patient complaining of a sore throat.

Brief Soldier: Tell the Soldier the simulated patient has a common throat infection that requires treatment.

<b>Performance Measures</b>	GO	NO GO
1 Gathered equipment and supplies.	_____	_____
2 Identified patient and inquired about allergies.	_____	_____
3 Provided privacy and safety for the patient.	_____	_____
4 Performed an HEENT examinations. (See task 081-833-0254.)	_____	_____
5 Identified throat disorders.	_____	_____
6 Provided treatment.	_____	_____
7 Documented treatment on SF 600.	_____	_____

**Evaluation Guidance:** Score each Soldier according to the performance measures. Unless otherwise stated in the task summary, the Soldier must pass all performance measures to be scored GO. If the Soldier fails any steps, show what was done wrong and how to do it correctly.

**References**

**Required**  
SF 600

**Related**  
None

## Provide Care for Common Respiratory Disorders

**081-833-0245**

**Conditions:** You have a patient with a respiratory complaint. You have performed a patient care handwash and taken body substance isolation (BSI) precautions. You have the patient's medical records, a stethoscope, sphygmomanometer, oto-ophthalmoscope, tongue depressors, and pen. You are not in a CBRN environment.

**Standards:** Provide care for a common respiratory disorder without causing further harm/injury to patient.

### Performance Steps

1. Identify the signs and symptoms of pneumonia.
  - a. Solicit a patient history.
    - (1) Cough frequently productive of purulent sputum (green, brown, rusty colored).
    - (2) Chest pain, pleuritic (worse with cough or deep breath).
    - (3) Shortness of breath at rest.
    - (4) Malaise, lethargy.
    - (5) Poor appetite.
  - b. Perform a physical exam and identify findings of pneumonia.
    - (1) Fever occasionally with shaking chills.
    - (2) Tachycardia.
    - (3) Tachypnea.
    - (4) Respiratory distress (retractions).
    - (5) Abnormal breath sounds: rhonchi, rales, wheezing.
    - (6) Abnormal pulse oximetry < 95%.
  - c. Consult with medical officer for treatment as applicable.
  - d. Provide care for pneumonia.
    - (1) Motrin or tylenol for fever.
    - (2) Decongestant: sudafed, entex (do not give antihistamines).
    - (3) Cough suppressants if trouble sleeping at night.
    - (4) Increase fluid intake.
    - (5) Antibiotics are the mainstay of therapy (consult medical officer).
    - (6) Bronchodilators.
    - (7) Consider bed rest/ profile, evacuate if in field environment.
  - e. Record all treatment in the patient's medical record.
  - f. Patients with a suspected pneumonia will be referred to a medical officer.
2. Identify the signs and symptoms of asthma.
  - a. Solicit a patient history (may vary widely from mild to life threatening).

- (1) Shortness of breath after exercise or upon awakening.
  - (2) History of wheezing.
  - (3) Chronic cough (usually non-productive).
  - (4) Nocturnal attacks.
  - (5) Triggers.
    - (a) Emotional upsets.
    - (b) Physical exertion.
    - (c) Cold weather.
    - (d) Upper respiratory infection (URI).
    - (e) Allergic components are pollen, mold, house dust, animal dander, smoke, medications, etc.
  - b. Perform a physical exam and identify findings of asthma.
    - (1) Dyspnea.
    - (2) Wheezing.
    - (3) Cough.
    - (4) Tachycardia.
    - (5) Decreased blood oxygenation.
  - c. Consult with medical officer for treatment as applicable.
  - d. Provide care for asthma and immediate treatment for acute attacks only.
    - (1) Inhaled bronchial dilators either metered dose inhaler (MDI) or nebulizers.
    - (2) IV hydration.
    - (3) Oxygen.
    - (4) Refer to medical officer.
    - (5) Evacuate immediately if in field environment.
  - e. Record all treatment in the patient's medical record.
  - f. Seek the advice and assistance of a higher medical authority whenever possible.
3. Identify the signs and symptoms of a viral upper respiratory infection.
- a. Solicit a patient history.
    - (1) Nasal congestion.
    - (2) Sore throat.
    - (3) Cough (productive or non-productive).
    - (4) Hoarseness.
    - (5) Malaise.
    - (6) Fatigue.
    - (7) Headache.

- (8) Sinus pressure.
  - b. Perform a physical exam and identify findings of a viral upper respiratory infection.
    - (1) Eyes; conjunctiva injected, increased lacrimation.
    - (2) Ears; tympanic membrane may be injected, moves poorly with Valsalva maneuver.
    - (3) Nose: mucoid or purulent nasal discharge, swollen mucus membranes, decreased air movement.
    - (4) Throat: oropharynx injected, tonsillar pillars may be swollen with or without exudate.
    - (5) Neck: supple, tender to palpation with shoddy, lymph nodes usually in the anterior chain.
    - (6) Chest: lungs may be clear or have scattered rhonchi or mild wheezing, usually no retractions or accessory muscle use.
    - (7) Vital signs: temperature, normal to low grade 100-101F°.
  - c. Consult with medical officer for treatment as applicable.
  - d. Provide care for the viral upper respiratory infection.
- NOTE:* Treatment and care for a viral upper respiratory infection is symptomatic.
- e. Record all treatment in the patient's medical record.
  - f. Seek the advice and assistance of a higher medical authority whenever possible.

**Evaluation Preparation:**

Setup: For training and evaluation, use another Soldier with symptoms of a respiratory illness.

Brief Soldier: Tell the Soldier to provide care for the common respiratory disorder on the simulated patient.

<b>Performance Measures</b>	GO	NO GO
1 Identified the signs and symptoms of pneumonia.	_____	_____
2 Identified the signs and symptoms of asthma.	_____	_____
3 Identified the signs and symptoms of a viral upper respiratory infection.	_____	_____

**Evaluation Guidance:** Score each Soldier according to the performance measures in the evaluation guide. Unless otherwise stated in the task summary, the Soldier must pass all performance measures to be scored a GO. If the Soldier fails any step, show what was done wrong and how to do it correctly.

**References**

**Required**  
None

**Related**  
None

## Provide Treatment for a Behavioral Emergency

081-833-0246

**WARNING:** Be alert for personal safety or scene safety problems while providing treatment for a behavioral emergency. Do not isolate yourself from other sources of help.

**Conditions:** You have a patient with a suspected behavioral emergency. The scene is safe. You have treated and managed all other immediate life threats. You have performed a patient care handwash and taken body substance isolation (BSI), precautions. You will need the patient's medical records, physician's order for use of restraints, if applicable, restraint devices, pen, and SF 600 (Medical Record-Chronological Record of Medical Care). You are not in a CBRN environment.

**Standards:** Provide treatment for a behavioral emergency without causing injury to patient.

### Performance Steps

1. Recognize a behavioral emergency.
  - a. Panic.
  - b. Agitation.
  - c. Bizarre thinking and behavior.
  - d. Danger to self–self destructive behavior, suicide.
  - e. Danger to others–threatening behavior, violence.
2. Recognize general factors that may alter a patient's behavior.
  - a. Situational stresses.
    - (1) Fires.
    - (2) Accidents.
    - (3) Deaths.
  - b. Medical illnesses.
    - (1) Dehydration.
    - (2) Low blood sugar, particularly in patients with diabetes (DM).
    - (3) Lack of oxygen.
    - (4) Inadequate blood flow to brain.
    - (5) Head trauma.
    - (6) Mind-altering substances.
    - (7) Excessive cold.
    - (8) Excessive heat.
    - (9) Neurologic disease, injury.
  - c. Psychiatric disorders/problems.
    - (1) Anxiety or panic attacks.
    - (2) Phobia.
    - (3) Depression.



*NOTE:* May be seen as the presenting condition at the health care facility or may be masked by the presentation of anxiety and somatic complaints.

- (4) Bipolar disorder.
- (5) Hallucinations.

**CAUTION:** Never play along with hallucinations or delusions. Do not lie to the patient.

- (6) Paranoia.
  - (7) Suicide ideation.
  - (8) Schizophrenia.
  - d. Alcohol and drug intoxication/withdrawal.
  - e. Violent patient(s).
3. Recognize signs and symptoms of physiological causes of behavioral emergencies.
- a. Unusual odors on the patient's breath.
  - b. Dilated, constricted, or unequally reactive pupils.
  - c. Tachycardia and tachypnea.
  - d. Numbness and tingling in fingers.
  - e. Patient feels incapable of functioning.
  - f. Mental and emotional signs.
    - (1) Anxious, keyed up, worried, expects the worse.
    - (2) Irritable, swearing, complaining, easily bothered.
    - (3) Difficulty paying attention, remembering details.
    - (4) Difficulty thinking, speaking, communicating.
    - (5) Trouble sleeping, awakened by bad dreams.
    - (6) Tearful and crying.
    - (7) Feeling badly about mistakes or what had to be done.
    - (8) Angry, often inappropriately directed.
    - (9) Beginning to lose confidence in self.
  - g. Rapid rather than gradual onset of symptoms.
  - h. Excessive salivation.
  - i. Loss of bladder control.
  - j. Hallucinations.
4. Solicit a patient history.
- a. Appearance and behavior.
    - (1) Grooming.
    - (2) Emotional status.
    - (3) Body language.

b. Emotional stability.

(1) Mood and feelings.

(a) Depressed patient: Observe for sadness, apathy, feeling of worthlessness, self-blame, suicidal thoughts, desire to escape, worsening of mood in morning, anorexia, weight loss, sleeplessness, lessening interest in sex, reduction of activity, or ceaseless activity.

(b) Violent patient:

o Assess for overactivity, aggression, or anger out of proportion to the circumstances.

o Determine risk factors for violence, including intoxicated with drugs/alcohol withdrawal and acute paranoid schizophrenic states, acute organic brain syndrome, acute psychosis, paranoia, or borderline personality.

(2) Thought process.

c. Cognitive abilities.

(1) State of consciousness.

(a) Orientation to person.

(b) Orientation to place.

(c) Orientation to time.

(d) Orientation to events, if appropriate.

(2) Memory.

(3) Attention span.

(4) Judgment.

d. Speech and language.

e. Risk for suicide.

(1) Previous suicide attempt.

(2) Personality traits such aggression, impulsivity, depression and hopelessness.

(3) Individuals, who have experienced early loss, decreased social support, chronic illness, or divorce.

(4) Genetic familial factors such as family history of suicide and previous history of self-destructive behavior.

(5) Determine whether patient has communicated suicidal intent, such as preoccupation with death or talking about someone else's death.

(6) Determine whether there is a specific plan for suicide and a means to carry out the plan.

5. Manage the behavioral emergency.

a. Act in a calm manner.

b. Identify yourself and your role.

c. Acknowledge that the patient seems upset and restate that you are there to help.

- d. Always try to talk the patient into cooperation.
- e. Speak slowly and clearly.
- f. Use positive body language.
- g. Do not enter the patient's space, stay about 3 feet away.
- h. Give patient time to gain control of emotions.
- i. Quietly and carefully evaluate the situation.
- j. Keep your own emotions under control. Do not be judgmental and show compassion.
- k. Honestly explain things to the patient.
- l. Let the patient know that you are listening to what they are saying.
- m. Stay alert for sudden changes in behavior.

*NOTE:* Consider restraints if necessary to keep the patient from harming themselves or others. (See task 081-833-0076.)

- n. Refer to medical officer as soon as possible.

6. Document all findings and care provided on SF 600.

**Evaluation Preparation:**

Setup: For training and evaluation, use another Soldier simulating a behavioral emergency.

Brief Soldier: Tell the Soldier the simulated patient requires treatment for a behavioral emergency.

<b>Performance Measures</b>	<b>GO</b>	<b>NO GO</b>
1 Recognized a behavioral emergency.	_____	_____
2 Recognized general factors that may alter a patient's behavior.	_____	_____
3 Recognized signs and symptoms of physiological causes of behavioral emergencies.	_____	_____
4 Solicited a patient history.	_____	_____
5 Managed the behavioral emergency.	_____	_____
6 Documented all findings and care provided on SF 600.	_____	_____

**Evaluation Guidance:** Score each Soldier according to the performance measures. Unless otherwise stated in the task summary, the Soldier must pass all performance measures to be scored GO. If the Soldier fails any steps, show what was done wrong and how to do it correctly.

**References**

**Required**  
SF 600

**Related**  
None

## **Perform a Military Acute Concussion Evaluation (MACE) Screening for Traumatic Brain Injury**

**081-833-0247**

**Conditions:** A casualty requires an assessment to determine whether a traumatic brain injury (TBI) has occurred. You will need a military acute concussion evaluation (MACE) screening tool. You are not in a CBRN environment.

**Standards:** Perform a MACE screening for a casualty with a suspected TBI.

### **Performance Steps**

1. Obtain a history of the patient.

*NOTE:* A concussion is a mild TBI. The purpose of the MACE is used to evaluate a person in whom a concussion is suspected.

- a. Description of the incident.

*NOTE:* Anyone who was dazed, confused, "saw stars" or lost consciousness as a result of an explosion/blast, fall, motor vehicle accident or other event involving abrupt head movement, a direct blow to the head or other head injury should be evaluated using the MACE screening tool.

- (1) What happened?
- (2) Tell me what you can remember.
- (3) Were you dazed, confused, saw "stars"?
- (4) Did you hit your head?
- (5) Was a helmet worn? What type?
- (6) Any history of amnesia before or after the incident? If yes, how long?
- (7) Any loss of consciousness? If yes, how long?

- b. Cause of injury.

- (1) Explosion/Blast.
- (2) Blunt object.
- (3) Motor vehicle crash.
- (4) Fragment.
- (5) Fall.
- (6) Gun shot wound.
- (7) Other.

- c. Symptoms.

- (1) Headache.
- (2) Memory problems.
- (3) Dizziness.
- (4) Balance problems.
- (5) Nausea or vomiting.
- (6) Difficulty concentrating.

- (7) Irritability.
- (8) Visual disturbances.
- (9) Other.

2. Perform a physical examination on the casualty.

*NOTE:* There are five domains of neurological function: Orientation, Immediate Memory, Neurological Screening, Concentration and Delayed Recall.

a. Orientation.

- (1) Ask the casualty to tell you the present month, date, and day of the week and time.
- (2) Award one point for each correct response with a maximum of five points.
- (3) Record the results.

b. Immediate memory.

- (1) Ask the casualty to remember five words and repeat them in any order.
- (2) Repeat this two more times for a total of three times.
- (3) Award one point for each correct response for a maximum of 15 points.

c. Neurological screening.

- (1) Check eyes for pupillary response and tracking.
- (2) Check speech for fluency and word finding.
- (3) Evaluate motor responses, gait and coordination.
- (4) Do not award points for these, but record any abnormalities.

d. Concentration.

- (1) Provide the casualty with four strings of numbers and ask him to repeat them back to you in reverse order.
- (2) Ask the casualty to recite the months of the year in reverse order.
- (3) Award one point for each string of numbers correctly repeated and one point for the correct reversed sequence of months for a maximum of four points.
- (4) If the casualty fails to repeat the first two strings of numbers, stop and move to delayed recall.

e. Delayed recall.

- (1) Ask the casualty to recall the five words from the previous memory test.
- (2) Award one point for each correct response for a maximum of five points.

3. Compute the total score on the MACE screening tool and determine whether a concussion has occurred or not.

4. Refer the casualty for further evaluation if the score is below 25.

*NOTE:* Scores below 25 may represent clinically relevant neurocognitive impairment and require further evaluation for the possibility of a more serious brain injury.

**Evaluation Preparation:**

Setup: For training and evaluation, use another Soldier to simulate a casualty with symptoms of a mild traumatic brain injury.

Brief Soldier: Tell the Soldier to screen the casualty using the MACE screening tool.

<b>Performance Measures</b>	<b>GO</b>	<b>NO GO</b>
1 Obtained a casualty history.	_____	_____
2 Performed a physical examination.	_____	_____
3 Computed the total score on the MACE screening tool and determined whether a concussion has occurred or not.	_____	_____
4 Referred casualty for further evaluation if score was below 25.	_____	_____

**Evaluation Guidance:** Score each Soldier according to the performance measures. Unless otherwise stated in the task summary, the Soldier must pass all performance measures to be scored GO. If the Soldier fails any steps, show what was done wrong and how to do it correctly.

**References**

**Required**  
None

**Related**  
None

## Provide Treatment for Common Ear Infections

**081-833-0241**

**Conditions:** You have a patient complaining of an ear infection. All other apparent life threats have been treated and managed. You have performed a patient care handwash and taken body substance isolation (BSI), precautions. You will need an otoscope, disposable speculum attachments, penlight, or other light source, and SF 600 (Medical Record-Chronological Record of Medical Care). You are not in a CBRN environment.

**Standards:** Provide treatment for common ear infections without causing harm to the patient.

### Performance Steps

1. Gather equipment and supplies.
2. Identify patient and inquire about allergies.
3. Provide privacy and safety for the patient.
  - a. Place patient in position of comfort, as long as procedure permits.
  - b. Explain procedure to patient.
4. Perform a head, eyes, ears, nose and throat (HEENT) examination. (See task 081-833-0254.)
5. Identify common ear disorders.

**NOTE:** Over 50% of ear pain complaints are dental in nature.

- a. Cerumen impaction—wax in the ears.
  - (1) Common Causes—wax is a natural byproduct of the body. Occasionally, cerumen impaction is caused by the improper use of Q-Tips®.
  - (2) Signs and Symptoms can include hearing loss and dizziness. It rarely causes pain.
- b. Otitis Externa—O.E. (swimmers' ear) inflammation and/or infection of the external auditory canal (EAC).
  - (1) Common causes—excessive moisture in the ear canal (swimming, use of ear plugs or hearing aids) or trauma are the most common causes of O.E. Bacterial or viral causes are also common. It is rarely a fungal infection.
  - (2) Signs and Symptoms include ear pain, ear canal swelling, drainage, and increased pain on movement of the auricle. A low grade fever may be present.

- c. Otitis media O.M. – middle ear infection.

**NOTE:** Otitis media is a condition that is typically unilateral (occurs in one ear).

- (1) Common causes – viral and bacterial.
- (2) Signs and symptoms include fever, ear pain, decreased hearing in the affected ear, and the tympanic membrane (TM) will be bulging and red.

**NOTE:** The cone of light that is commonly seen with an otoscopic examination will generally be absent.

6. Provide treatment for common ear disorders.
  - a. Cerumen impaction.
    - (1) Perform an ear irrigation, if trained to do so.
    - (2) Refer to a medical officer after the irrigation.

*NOTE:* Ear irrigation or uses of ear drops that will dissolve the earwax are effective.

b. Otitis Externa O.E. (swimmer’s ear).

(1) Referral to MO.

(2) Oral antibiotics and pain medication will be prescribed.

*NOTE:* Irrigation of the ear canal is not recommended. MO may prescribe antibiotic/steroid ear drops as the first line of treatment and a non-steroidal anti-inflammatory drug (NSAID) such as Ibuprofen for pain.

c. Otitis media O.M.

(1) Referral to MO.

(2) Oral antibiotics and pain medication will be prescribed.

7. Document treatment and patient’s response to treatment on SF 600.

**Evaluation Preparation:**

Setup: For training and evaluation, use another Soldier as a simulated patient complaining of an ear complaint.

Brief Soldier: Tell the Soldier the simulated patient has a common ear disorder that they need to provide treatment for.

<b>Performance Measures</b>	GO	NO GO
1 Gathered equipment and supplies.	_____	_____
2 Identified patient and inquired about allergies.	_____	_____
3 Provided privacy and safety for patient.	_____	_____
4 Performed an HEENT examination.	_____	_____
5 Identified common ear disorders.	_____	_____
6 Provided treatment for common ear disorders.	_____	_____
7 Documented treatment and patient’s response on the SF 600.	_____	_____

**Evaluation Guidance:** Score each Soldier according to the performance measures. Unless otherwise stated in the task summary, the Soldier must pass all performance measures to be scored GO. If the Soldier fails any steps, show what was done wrong and how to do it correctly.

**References**

**Required**  
SF 600

**Related**  
None



## Treat Skin Disorders

**081-833-0125**

**Conditions:** You are evaluating a patient with a skin disorder. All other apparent life threats or anaphylactic signs and symptoms have been taken care of. You have identified the patient, and have the patient's medical records. You will need a standard fully stocked aid bag, pen, and SF 600 (Medical Record-Chronological Record of Medical Care). You have performed a patient care handwash and taken body substance isolation (BSI) precautions. You are not in a CBRN environment.

**Standards:** Treat skin disorders without causing harm or injury to the patient.

### Performance Steps

1. Obtain a patient history.
    - a. Related lesions.
    - b. Secondary lesions.
    - c. Shape and configuration.
    - d. Rash or other complaints related to the dermatologic conditions.
      - (1) When did the rash first occur?
      - (2) Was the onset sudden or gradual?
      - (3) What site was first affected?
      - (4) Describe the spread and its severity.
      - (5) Is there any associated pruritis (itching), burning, tingling, pain or numbness (constant or intermittent), or fever?
  2. Identify and manage viral disorders of the skin.
    - a. Herpes simplex.
      - (1) Assessment findings include grouped vesicles on a red base, most commonly noted at the corner of the mouth, (cold sore), or on the cervix or labia on women and the penis of men.

*NOTE:* Vesicles appear, ulcerate and encrust. When a vesicle ruptures a burning pain is felt.

      - (2) Management.
        - (a) Abstain from sexual activity until infection is resolved.
        - (b) Antiviral medications are indicated-refer to a medical officer for treatment.
        - (c) Counsel patient on safe sex practices - condom usage.
    - b. Herpes zoster vesicle (shingles).
      - (1) Lesions located along the nerve fibers of spinal ganglia where inflammation occurs.
      - (2) Forms an erythematous rash of small vesicles along a spinal nerve pathway.
      - (3) Assessment findings.
        - (a) Rash generally in thoracic region.
- 1) Many occur elsewhere.

2) Follow dermatomal pattern.

- (b) Vesicles rupture and form crust.
- (c) Serous fluid in vesicle may become purulent.
- (d) Last 7 to 28 days.
- (e) Patients report severe burning and/or knife-like pain.
- (f) Does not cross midline unless the patient is immuno-compromised.

(4) Management-refer patient to a medical officer for treatment.

3. Identify and manage bacterial disorders.

a. General characteristics.

- (1) Commonly occur in warm, moist locations but may be secondary to local trauma.
- (2) All bacterial infections need to be aggressively treated in a field environment.

b. Impetigo.

(1) Assessment findings.

- (a) Appears on face, hands, arms, and legs.
- (b) Pustular lesions distributes over involved area.
- (c) Large amount of dried serous exudate (honey colored crust).
- (d) Spread by touching personal articles, linens, and clothing.

(2) Management.

- (a) Consider antiseptic soap.
- (b) Consider application of antibiotic cream, ointment, or lotion.
- (c) Refer to a medical officer for treatment.

c. Folliculitis, furuncles, carbuncles, and felons.

(1) Assessment findings.

- (a) Edematous, erythematous, and painful.
- (b) Pruritus commonly occurs.
- (c) Infected area becomes shiny, points up, and if furuncle or carbuncle, the center turns yellow.
- (d) Carbuncles can have four to five cores with spontaneous rupture of core.
- (e) Pain stops immediately upon rupture of core.

(2) Management. (Felons may spread to fascial planes in the hand and may require surgical exploration and debridement.)

- (a) Isolate patient to prevent spread of infection.
- (b) Refer to a medical officer for treatment.

4. Identify and manage fungal infections of the skin.

a. General characteristics.

- (1) Are not part of the normal flora.
- (2) About 20 species produce skin diseases.
- b. Tinea capitis (ringworm of the scalp).
  - (1) Spread by contact with infected articles.
  - (2) Trauma or irritation breaks in skin facilitates spread.
    - (a) Assessment findings.
      - 1) Areas of brittle or broken off hairs with some crusting.
      - 2) Occasionally pruritus.
      - 3) Non-scarring alopecia occurs at the site.
        - (b) Management-refer to medical officer for treatment.
  - c. Tinea corporis (ringworm of the body). Occurs in parts of body with little or no hair.
    - (1) Assessment findings.
      - (a) Produces lesions with raised erythemic borders as lesions expand there is central clearing (annular lesion).
      - (b) May have scales.
      - (c) May or may not have pruritus.
    - (2) Management-consider use of topical or oral antifungal drugs. Refer to medical officer if topical agents are not effective
  - d. Tinea cruris (jock itch). Found in groin area.
    - (1) Assessment findings.
      - (a) Produces lesions with raised erythemic borders as lesions expand there is central clearing (annular or arciform lesions).
      - (b) Pruritus and skin excoriation from scratching may be found.
      - (c) May spare scrotum.
    - (2) Management.
      - (a) Consider methods of drying out area such as loose clothing (use of boxers or no underwear) and powder.
      - (b) Consider use of topical or oral antifungal drugs.
      - (c) Refer to medical officer if topical agents are not effective.
  - e. Tinea pedis (athlete's foot). Normally starts between 4th and 5th toes and then may spread.
    - (1) Assessment findings.
      - (a) Itching and burning.
      - (b) Maceration between toes.
      - (c) Cracking and peeling of interdigital skin.
      - (d) If secondarily infected may have associated discoloration.

- (2) Management.
  - (a) Powder.
  - (b) Frequent sock changes.
  - (c) Rotation of footwear.
- (3) Consider use of topical or oral antifungal drugs.
- (4) Refer to medical officer if topical agents are not effective.

5. Identify and manage inflammatory disorders.

*NOTE:* This disorder is a local or generalized inflammation caused by a number of factors.

a. General characteristics.

- (1) Can be caused by numerous agents such as drugs, plants, chemicals, metals, and food.
- (2) Erythema and edema in acute disorders.
- (3) Skin thickening and chronic pigmentation in chronic disorders.
- (4) Pruritus is almost always present; if present it can cause excoriation due to scratching.

b. Contact dermatitis (irritant and allergic).

- (1) Caused by direct contact with agents who cause irritation or allergic reaction.
- (2) Epidermis becomes inflamed and damaged.
- (3) Common causes are detergents, soaps, industrial chemicals, medications, hypersensitivity reactions, and plants such as poison ivy.

(a) Assessment findings.

- o Lesions appear at point of contact.
- o Patient feels burning, pain, pruritus, and edema.
- o Involved area becomes erythematous with papules.
- o Vesicles appear most often on dorsal surfaces.

(b) Management.

- o Identify cause of hypersensitive reaction.
- o Symptomatic treatment for inflammation, edema, and pruritus.

6. Document treatment provided on SF 600.

7. Provide information on the prevention of skin disorders.

*NOTE:* Tell the patient to maintain healthy skin by avoiding causative agents (poison ivy, excessive sunlight). Always inspect the skin after each mission and avoid self treatment of anything out of the ordinary.

**Evaluation Preparation:**

Setup: For training and evaluation, use another Soldier as the patient.

Brief Soldier: Tell the Soldier the simulated patient has a dermatologic disorder that requires treatment. Provide a dermatologic scenario for the patient to answer questions from.

**Performance Measures**

	GO	NO GO
1 Obtain a patient history.	_____	_____
2 Identified and managed viral disorders of the skin.	_____	_____
3 Identified and managed bacterial disorders.	_____	_____
4 Identified and managed fungal infections of the skin.	_____	_____
5 Identified and managed inflammatory disorders.	_____	_____
6 Documented treatment given on SF 600.	_____	_____
7 Provided information on the prevention of skin disorders.	_____	_____

**Evaluation Guidance:** Score each Soldier according to the performance measures. Unless otherwise stated in the task summary, the Soldier must pass all performance measures to be scored GO. If the Soldier fails any steps, show what was done wrong and how to do it correctly.

**References**

**Required**  
SF 600

**Related**  
None

## Perform a Patient Care Handwash

081-831-0007

**Conditions:** You need to perform a patient care handwash. You will need running water or two empty basins, a canteen, a water source, soap, towels (cloth or paper), and a towel receptacle or trash can. You are not in a CBRN environment.

**Standards:** Perform a patient care handwash without contaminating the hands.

### Performance Steps

1. Remove wristwatch and jewelry, if applicable.

*NOTE:* Rings should not be worn. If rings are worn, they should be of simple design with few crevices for harboring bacteria. Fingernails should be clean, short, and free of nail polish.

2. Roll shirt sleeves to above the elbows, if applicable.

3. Prepare to perform the handwash.

- a. If using running water, turn on the warm water.
- b. If running water is not available, set up the basins and open the canteen.

4. Wet your hands, wrists, and forearms.

- a. If using running water, hold your hands, wrists, and forearms under the running water.

b. If running water is not available, fill one basin with enough water to cover your hands and refill the canteen.

5. Cover your hands, wrists, and forearms with soap.

*NOTE:* For routine patient care, use regular hand soap. For an invasive procedure such as a catheterization or an injection, use antimicrobial soap.

6. Wash your hands, wrists, and forearms.

a. Use a circular scrubbing motion, going from the fingertips toward the elbows for at least 15 seconds.

- b. Give particular attention to creases and folds in the skin.

- c. Wash ring(s) if present.

7. Rinse your hands, wrists, and forearms.

- a. If using running water.

(1) Hold your hands lower than the elbows under the running water until all soap is removed.

- (2) Do not touch any part of the sink or faucet.

- b. If not using running water.

- (1) Use a clean towel to grasp the canteen with one hand.

(2) Rinse the other hand, wrist, and forearm, letting the water run into the empty basin. Hold your hands lower than the elbows.

- (3) Repeat the procedure for the other arm.

- (4) Do not touch any dirty surfaces while rinsing your hands.

8. Dry your hands, wrists, and forearms.

- a. Use a towel to dry one arm from the fingertips to the elbow without retracing the path with the towel.
- b. Dispose of the towel properly without dropping your hand below waist level.
- c. Repeat the process for the other arm using another towel.
- 9. Use a towel to turn off the running water, if applicable.
- 10. Re-inspect your fingernails and clean them and rewash your hands, if necessary.

**Evaluation Preparation:**

Setup: None.

Brief Soldier: Tell the Soldier to perform a patient care handwash.

**Performance Measures**

	GO	NO GO
1 Removed wristwatch and jewelry, if applicable.	_____	_____
2 Rolled shirt sleeves to above the elbows, if applicable.	_____	_____
3 Prepared to perform the handwash.	_____	_____
4 Wet the hands, wrists, and forearms.	_____	_____
5 Covered the hands, wrists, and forearms with soap.	_____	_____
6 Washed the hands, wrists, and forearms.	_____	_____
7 Rinsed the hands, wrists, and forearms.	_____	_____
8 Dried the hands, wrists, and forearms.	_____	_____
9 Used a towel to turn off the running water, if applicable.	_____	_____
10 Re-inspected the fingernails and cleaned them and rewash the hands, if necessary.	_____	_____

**Evaluation Guidance:** Score each Soldier according to the performance measures. Unless otherwise stated in the task summary, the Soldier must pass all performance measures to be scored GO. If the Soldier fails any steps, show what was done wrong and how to do it correctly.

**References**

**Required**  
None

**Related**  
None

**Document Patient Care using Subjective, Objective, Assessment, Plan (SOAP) Note Format**

**081-833-0145**

**CAUTION:** All body fluids should be considered potentially infectious. Always observe body substance isolation (BSI) precautions by wearing gloves and eye protection as a minimal standard of protection.

**Conditions:** You are treating a patient and must record the treatment given. You will need medical documentation forms (as specified by local SOP), a black pen, and SF 600 (Medical Record-Chronological Record of Medical Care). You are not in a CBRN environment.

**Standards:** Record patient care accurately using SOAP note documentation format. Make entries legible in non-erasable black, use only approved medical abbreviations, do not skip lines or leave space between lines, and finish the entry with the required information. Guard confidentiality of all patient information.

**Performance Steps**

1. Record the patient's name, rank, SSN, date and time.
2. Write subjective data.
  - a. Chief complaint.
    - b. The patient's statements regarding the illness or injury history to include onset, provocation/palliation, quality, radiation/region, severity, time (OPQRST).
    - c. Usually expressed in the patient's own words.
3. Write objective data.
  - a. Observations by the Soldier Medic that support or are related to the subjective data, to include sight, sound, touch, and smell.
  - b. Physical assessment data to include the patient's vital signs.
  - c. Lab and radiology results.
4. Write the assessment/analysis.
  - a. Your interpretation of the patient's problem/condition.
  - b. Conclusions reached based upon analysis of the subjective and objective data.
5. Write the plan.
  - a. Course of action to resolve the problem.
    - (1) Treatments made.
    - (2) Profiles.
    - (3) Medications.
    - (4) Patient education.
  - b. Follow-up appointment or referral.
  - c. Each item in your plan should be numbered.
6. Correct recording errors, if applicable.
  - a. Draw a single line through the error.



- b. Write the word error above it.
- c. Initial next to the error.
- d. Record the note correctly on SF 600.

7. Finish the entry with your signature, printed name, rank, and title.

**NOTE:** Medical confidentiality of all patient information must be guarded. Unauthorized disclosure of medical information is grounds for Uniform Code of Military Justice (UCMJ) action against the informant.

**Evaluation Preparation:**

Setup: For training and evaluation, construct a written scenario that has all of the elements necessary for the Soldier to develop and write a concise record of patient care using the SOAP note documentation format.

Brief Soldier: Tell the Soldier to record patient care using the SOAP note documentation format.

<b>Performance Measures</b>	GO	NO GO
1 Recorded required patient information on SF 600.	_____	_____
2 Wrote subjective data.	_____	_____
3 Wrote objective data.	_____	_____
4 Wrote the assessment/analysis.	_____	_____
5 Wrote the plan.	_____	_____
6 Corrected errors, if applicable.	_____	_____
7 Finished the with your signature, printed name, rank, and title.	_____	_____

**Evaluation Guidance:** Score each Soldier according to the performance measures. Unless otherwise stated in the task summary, the Soldier must pass all performance measures to be scored GO. If the Soldier fails any steps, show what was done wrong and how to do it correctly.

**References**

**Required**  
SF 600

**Related**  
None

## Provide Treatment for Abdominal Disorders

081-833-0239

**Conditions:** You have a patient with an abdominal complaint. You have performed a patient care handwash and taken body substance isolation (BSI) precautions. You will need a stethoscope, pen, SF 600 (Medical Record-Chronological Record of Medical Care), and the patient's medical record. You are not in a CBRN environment.

**Standards:** Solicit a patient history, perform a physical examination, determine the cause of the disease, and administer supportive care in accordance with (IAW) guidance from the medical officer.

### Performance Steps

1. Solicit a patient history.
  - a. History of present illness (HPI).
  - b. Chief complaint (usually in patient's own words).
  - c. Use onset, provocation/palliation, quality, region/radiation, severity, timing (OPQRST) type questions.
  - d. Past medical history (PMH).
  - e. Family history (FH).
  - f. Social history (SH).
  - g. Menstrual history (women of childbearing age).
  - h. Travel history.
2. Perform an abdominal physical exam.
  - a. Inspection.

**NOTE:** Inspection can detect an incisional or umbilical hernia or an abnormality caused by bowel obstruction.

- (1) Observe the abdominal contour.
  - (2) Skin characteristics.
  - (3) Symmetry.
  - (4) Peristalsis.
  - (5) Pulsations.
  - (6) Presence of the following:
    - (a) Masses.
    - (b) Hernia.
    - (c) Separation of muscles.
- b. Auscultation.
  - c. Percussion.
    - (1) From below the right breast to the inguinal area down the right midclavicular line.
    - (2) From below the left breast to the inguinal area down the left midclavicular line.

## d. Palpation.

- (1) Palpate for the kidneys on each side of the abdomen.
- (2) Palpate the liver at the right costal border.
- (3) Palpate for the spleen at the left costal border.
- (4) Palpate the femoral pulses in the groin.

3. Check for red flags of abdominal symptoms (must see a medical officer as soon as possible (ASAP)).

- a. Abdominal pain with guarding or rebound tenderness or progressive severe pain that persists without improvement for over 6 hours.
- b. Recent (< 6 months) abdominal surgery.
- c. Abdominal pain with fever.
- d. Abdominal pain with tachycardia.
- e. Abdominal pain with dehydration.
- f. Abdominal pain in a pregnant patient.

4. Identify and manage gastroesophageal reflux disease (GERD).

## a. Signs and symptoms.

(1) Heartburn, burping, regurgitation (worse after eating large meal, when lying down, in the middle of night).

*NOTE:* Cardiac disease must be ruled out before the diagnosis of GERD is made, especially if the symptom is chest pain (consult with medical officer).

(2) Physical exam is usually normal.

(3) Red Flags: bloody vomitus, blood in stool, dark tarry stools, significant weight loss.

b. Treatment—refer all abdominal pain patients to the medical officer.

## (1) Medications.

- (a) Antacids (Tums®, Roloids®).
- (b) H2 Blockers (Tagamet®, Zantac®).
- (c) Proton Pump Inhibitors (Prilosec®, Aciphex®).

## (2) Lifestyle changes.

- (a) Weight loss.
- (b) Avoid alcohol, tobacco, caffeine and large meals.
- (c) Elevate the head of your bed.

5. Identify and manage gastroenteritis.

## a. Signs and symptoms.

- (1) Nausea, vomiting, diarrhea (may be mild or severe).
- (2) Malaise, fever, abdominal cramps.
- (3) May have history of eating or drinking from an unapproved source.

- b. Physical Exam.
  - (1) May be normal, but abdomen may be diffusely tender if prolonged vomiting.
  - (2) Normal to increased bowel sounds.
- c. Red Flags.
  - (1) Vomiting blood (hematemesis), or bloody diarrhea.
  - (2) Fever (febrile).
  - (3) Signs of dehydration.
  - (4) Protracted vomiting or diarrhea.
- d. Treatment.
  - (1) Medications: check with medical officer for antiemetic if vomiting is severe.
  - (2) Correct fluid loss if signs of dehydration.
  - (3) Clear liquid diet.
  - (4) Bed rest may be indicated (check with medical officer).
- 6. Identify and manage constipation.
  - a. Signs and symptoms.
    - (1) History of delayed or difficult bowel movements (BMs) (may be hard and dry).
    - (2) Crampy abdominal pain, painful BMs.
  - b. Crampy abdominal pain, painful BMs.
    - (1) Usually normal (may have tenderness to palpation if severe).
    - (2) Bowel sounds variable (may be increased, normal, or decreased).
  - c. Treatment.
    - (1) Increase fluid and fiber intake.
    - (2) Laxatives and stool softeners.
- 7. Identify and manage abdominal pain with peritoneal signs.
  - a. Signs and symptoms.
    - (1) Anorexia, with pain that is increasing in severity.
    - (2) Nausea, vomiting, diarrhea.
  - b. Physical exam.
    - (1) Fever.
    - (2) Guarding and rebound tenderness present (patient often will point to the right lower quadrant (RLQ)).
  - c. Treatment-severe abdominal pain is referred to the medical officer immediately.
- 8. Identify and manage hemorrhoids.
  - a. Signs and symptoms.
    - (1) Rectal itching.

- (2) Pain with bowel movement.
- (3) Rectal bleeding.
- b. Physical exam.
  - (1) Rectal bleeding, with obvious source (external hemorrhoid visible). If no obvious source refer to medical officer immediately.
  - (2) Ensure vital signs do not indicate a severe hemorrhage problem.
- c. Red flag. If bleeding is excessive or vital signs indicate hypovolemia notify the medical officer immediately.
- d. Treatment.
  - (1) Increase fiber and fluids in diet.
  - (2) Avoid straining.
  - (3) Sitz bath (sitting in warm water) for 15 minutes three times a day.
  - (4) Stool softener.
  - (5) Pain medications, topical (Dibucaine®) or oral (Tyleno®).

9. Identify and manage cystitis (bladder infection).

- a. Signs and symptoms.
  - (1) Urgency, frequency, dysuria (urinary triad).
  - (2) Malodorous urine.
  - (3) Hematuria (blood in urine).
- b. Physical exam.
  - (1) Fever may or may not be present.
  - (2) Costal vertebral angle tenderness (flank pain) with percussion.
- c. Treatment.
  - (1) Diagnosis confirmed by urinalysis.
  - (2) Requires antibiotics (refer to medical officer).

10. Identify and manage diarrheal conditions.

- a. Acute (symptoms are acute in onset and persist for less than 3 weeks).
  - (1) Signs and symptoms.
    - (a) Frequent loose or watery stools.
    - (b) Abdominal pain and cramping.
    - (c) History of travel outside the United States.
  - (2) Physical exam.
    - (a) Fever.
    - (b) Vital signs, orthostatic hypotension-(tilts) A drop in blood pressure when the patient changes position from lying to sitting or from sitting to standing. A drop of 10 millimeters

of mercury (mmHg) in systolic pressure or an elevation of the pulse rate by 20 beats per minute (bpm) can indicate a volume deficit.

- (c) Signs of a viral upper respiratory infection.
- (d) Tenderness on palpation of abdomen.
- (e) Bowel sounds may be (normal, increased, or decreased).

(3) Red flags: dehydration, bloody diarrhea, blood in stool, dark tarry stools (melena), severe abdominal pain and significant weight loss.

(4) Treatment.

(a) Diet. Clear liquids, progressing to bland diet. Avoid caffeine, dairy products and raw fruit and vegetables.

(b) Fluid resuscitation. IV or oral fluid and electrolyte replacement.

(c) Medications. Kaopectate® or Loperamide® (Imodium). Antibiotics may be required (check with medical officer).

(d) Consume food and water only from approved sources.

b. Chronic diarrhea - diarrhea persisting for more than three weeks.

(1) Chronic diarrhea may be viral, bacterial, or parasitic in nature. Diarrhea not caused by infections could be attributed to a number of malabsorptive, secretory, inflammatory or motility disorders. Sometimes the cause of chronic diarrhea remains unknown.

(2) Refer to the medical officer.

11. Document patient's response/tolerance to exam procedure(s) provided on SF 600.

**Evaluation Preparation:**

Setup: For training and evaluation use another Soldier with a simulated abdominal complaint.

Brief Soldier: Tell the Soldier the simulated patient has an abdominal disorder that requires a medical workup.

<b>Performance Measures</b>	<b>GO</b>	<b>NO GO</b>
1 Solicited a patient history.	_____	_____
2 Performed a physical examination.	_____	_____
3 Checked for red flags of abdominal symptoms.	_____	_____
4 Identified and managed gastroesophageal reflux disease (GERD).	_____	_____
5 Identified and managed gastroenteritis.	_____	_____
6 Identified and managed constipation.	_____	_____
7 Identified and managed abdominal pain with peritoneal signs (appendicitis).	_____	_____
8 Identified and managed hemorrhoids.	_____	_____
9 Identified and managed cystitis (bladder infection).	_____	_____
10 Identified and managed diarrheal conditions.	_____	_____
11 Documented patient's response/tolerance to exam procedure(s) and	_____	_____

**Performance Measures**

GO

NO GO

treatments provided on SF 600.

**Evaluation Guidance:** Score each Soldier according to the performance measures. Unless otherwise stated in the task summary, the Soldier must pass all performance measure to be scored GO. If the Soldier fails any steps, show what was done wrong and how to do it correctly.

**References**

**Required**  
SF 600

**Related**  
None

## Perform Visual Acuity Testing

081-833-0193

**Conditions:** You have a patient who requires evaluation of visual acuity. You will need an opaque eye card and a Snellen chart. You are not in a CBRN environment.

**Standards:** Administer the visual acuity test.

### Performance Steps

1. Identify the patient and provide privacy.
2. Perform a patient care hand wash. (See task 081-831-0007.)
3. Explain the procedure to the patient/family.
4. Position the patient 20 feet from the eye chart.
5. Instruct the patient to leave corrective lenses on, if worn, except for reading glasses.
6. Cover one eye with an opaque card and instruct the patient to read through the chart to the smallest line possible. Have the patient read from top to bottom, left to right.
7. Repeat the procedure for the other eye.
8. Repeat the exam with both eyes open.

*NOTE:* Certain situations, such as physical exams, may require this exam to be performed with and without corrective lenses. Review the facility standing operating procedure for guidance.

For pediatric patients who do not read, use symbols and picture charts.

9. If in field environment determine gross visual acuity.
  - a. Have the patient read any printed material available.
  - b. If the patient is unable to read printed material:
    - (1) Have patient determine the number of fingers held up.
    - (2) Distinguish between light and dark.

*NOTE:* Record the results as a fraction with the number 20 (= distance) as the numerator and the number of the last line read (= acuity) as the denominator. Also indicate the number of letters missed. Example: 20/30 -2.

10. Record results of the test.

**Evaluation Preparation:** None.

### Performance Measures

	GO	NO GO
1 Identified the patient and provided privacy.	_____	_____
2 Performed a patient care hand wash.	_____	_____
3 Explained the procedure to the patient/family.	_____	_____
4 Positioned the patient 20 feet from the eye chart.	_____	_____
5 Instructed the patient to leave corrective lenses on during exam.	_____	_____
6 Tested one eye.	_____	_____
7 Repeated testing on the other eye.	_____	_____
8 Repeated testing with both eyes open.	_____	_____



- 9 Performed gross visual acuity in field environment, if applicable. \_\_\_\_\_
- 10 Recorded the results of the test. \_\_\_\_\_

**Evaluation Guidance:** Score each Soldier according to the performance measures. Unless otherwise stated in the task summary, the Soldier must pass all performance measures to be scored GO. If the Soldier fails any steps, show what was done wrong and how to do it correctly.

**References**

**Required**  
None

**Related**  
None

## Subject Area 7: Musculoskeletal

### Apply a Rigid Splint

081-833-0263

**Conditions:** You have a casualty with a suspected fracture to an arm or leg. All other more serious injuries have been assessed and treated. You will need a rigid or formable splint, four muslin bandages (cravats), three inch tape and a six inch elastic bandage. You are not in a CBRN environment.

**Standards:** Splint the limb with the suspected fracture so it does not move and circulation is not impaired.

#### Performance Steps

1. Take body substance isolation precautions (BSI).
2. Prepare the casualty for the application of the splint.
  - a. Upper extremity injury.
    - (1) Have the casualty sit up.
    - (2) Have someone support the fractured extremity.
    - (3) Remove all jewelry from the fractured extremity.
    - (4) Expose the fracture site.
  - b. Lower extremity injury.
    - (1) Have the casualty sit or lie down.
    - (2) Have another person manually immobilize the fractured extremity.
    - (3) Remove the foot gear and expose the fracture site.

**WARNING:** If a pulse cannot be palpated, apply gentle manual traction in line with the long axis of the limb. This maneuver may restore the pulse. If a pulse does not return after one attempt, splint the limb in the most comfortable position for the casualty and evacuate the casualty immediately.

3. Check distal pulse and capillary refill on the injured extremity.
4. Prepare the splint for application.

**NOTE:** If using a formable splint, measure and shape the splint on the uninjured extremity.

- a. Forearm/wrist fracture.
  - (1) Fold the formable splint in half, upon itself creating a double layered splint, leaving one side approximately 1 inch longer than the other.
  - (2) Take the folded end of the formable splint and roll at least two times towards the side with the shortest end. This will provide a natural curvature for the hand when the splint is applied.
  - (3) Shape the formable splint into a C curve along the long axis from the rolled end to the opposite end.
  - (4) Shape the splint until the splint generally conforms to the curve and shape of the limb being splinted.
  - (5) Pad the splint and fill in the voids as needed.

## b. Elbow injury.

(1) The injured extremity should be placed in a V (bent) position with the forearm across the anterior thorax.

(2) Take one splint and fold it in half, creating a double layered splint. After folding the splint in half make a C curve along the long axis of the splint.

(3) Take another formable splint and fold it in half.

(4) After folding the second formable splint in half, fold the splint in half again but along the long axis of the splint.

(5) Pad the formable splint if needed.

## c. Fractured humerus.

(1) Fold one third of the 36 inch formable splint upon itself to create a 12 inch section of double-layered splint.

(2) Bend the double layered portion of the splint into a J and tape both layers together.

(3) Fold the rest of the splint into a slight C, along the long axis of the splint, to create rigidity.

## d. Ankle injury.

(1) Apply padding to the bony prominence of the medial and lateral ankle bones (medial and lateral malleolus).

(2) Fold a 36 inch formable splint to create two equal halves.

*NOTE:* When folding the formable splint, make sure that the middle fold is large enough to accommodate the foot.

(3) Fold both sides of the splint in a slight C to create rigidity along the long axis of the splint.

## e. Tibia/fibula fracture.

(1) Apply padding to the bony prominence of the medial and lateral ankle bones (medial and lateral malleolus).

(2) Completely extend the entire 36 inch formable splint.

(3) Curve approximately six inches of the splint into a J shape.

(4) Form a C curve along the long axis of the remaining 30 inches of the splint.

(5) Perform the same steps to another 36 inch formable splint.

## 5. Prepare cravats.

*NOTE:* If cravats are to be used in securing the splint to the injured extremity, position the cravats above and below the fracture site.

## 6. Apply and secure the splint to the injured extremity with the limb in the position of function.

## a. Forearm/wrist fracture.

(1) Place the fractured forearm in the splint with the hand in a natural curve on top of the rolled end of the splint.

(2) Tie one cravat proximal to the fracture site and one cravat distal to the fracture site.

(3) Tie the tails of the cravats in non-slip knot on the outside of the splint.

(4) Recheck the casualty's pulse and capillary refill below the most distal cravat. Loosen the cravats and reapply the splint if needed.

(5) Cut the tails of each cravat to prevent accidental entanglement when the casualty is moved.

(6) Apply and sling and swathe to further immobilize the fractured arm. (See task 081-833-0265.)

b. Elbow injury.

(1) While the arm is in the bent slight V position across the anterior thorax, place the formable splint that is folded in half along the long axis on the outside of the arm from the humerus to the forearm.

(2) Place the formable splint that is bent into a C curve on the inside of the arm, also running from the humerus to the forearm.

(3) The splint should extend approximately two inches past the forearm and two inches past the humerus.

(4) Tie both splints together with one cravat in the middle area of the anterior elbow crease. The injured extremity should still be sandwiched between both formable splints.

(5) Tie a cravat around both formable splints on the outside of the humerus.

(6) Tie a cravat around both formable splints just past the forearm.

(7) Apply a sling and swathe to further immobilize the fractured arm. (See task 081-833-0265.)

c. Fractured humerus.

(1) Support the casualty's arm in an L shape.

(2) Hook the elbow with the J portion of the splint, running the rest of the splint along the upper arm towards the shoulder (on the outside of the arm).

(3) Fold any excess splint that may be extending above the top of the shoulder, back upon itself (double layer).

(4) Secure the splint with an elastic bandage distal to proximal and secure the elastic bandage with tape.

(5) Apply a sling and swathe to further immobilize the fractured arm. (See task 081-833-0265.)

d. Ankle injury.

(1) Apply the splint to the ankle by placing the foot in the stirrup portion of the splint.

(2) Form the splint to the length of the lower leg.

(3) Secure the splint by wrapping the elastic bandage from the top of the foot, around the bottom of the foot and up the length of the splint.

(4) Tape the wrap in place.

e. Tibia/fibula fracture.

(1) Apply the splint to the outside area of the fractured tibia/fibula.

(2) Place the foot in the J portion of the splint and run the long axis of the splint up the leg toward the knee.

(3) Apply the second splint to the inside area of the fractured tibia/fibula.

(4) Place the foot (with the previous splint) into the J and run the long axis of the splint up the leg toward the knee.

(5) Wrap both splints around the lower leg with an elastic bandage starting from the top of the foot, around the bottom of the foot and then up the length of the splints toward the knee.

(6) Tape the wrap in place.

7. Recheck distal pulse.

*NOTE:* Recheck the distal pulse periodically to ensure that the swelling has not compromised the extremity. If swelling occurs and the distal pulse is lost, evacuate the casualty immediately.

8. Record treatment given on the appropriate medical form.

9. Evacuate the casualty.

**Evaluation Preparation:**

Setup: Provide a Soldier to act as a casualty. Have the formable splints and all materials for securing the splints and immobilizing the fractures available.

Brief Soldier: Tell the Soldier that the casualty has a suspected closed fracture and where it is located. Tell the Soldier to splint the suspected fracture.

<b>Performance Measures</b>	GO	NO GO
1 Took BSI precautions.	_____	_____
2 Prepared casualty for the application of the splint.	_____	_____
3 Checked distal pulse and capillary refill on the injured extremity.	_____	_____
4 Prepared the splint for application.	_____	_____
5 Prepared cravats.	_____	_____
6 Applied and secured the splint to the injured extremity with the limb in the position of function.	_____	_____
7 Rechecked the distal pulse.	_____	_____
8 Recorded treatment given on the appropriate medical form.	_____	_____
9 Evacuated the casualty.	_____	_____

**Evaluation Guidance:** Score each Soldier according to the performance measures. Unless otherwise stated in the task summary, the Soldier must pass all performance measures to be scored GO. If the Soldier fails any steps, show what was done wrong and how to do it correctly

**References**

**Required**  
None

**Related**  
None

## Apply an Elastic Bandage

081-833-0264

**CAUTION:** All body fluids should be considered potentially infectious. Always observe body substance isolation (BSI) precautions by wearing gloves and eye protection as a minimal standard of protection.

**Conditions:** You have a patient needing an elastic bandage applied. You will need roller bandages, adhesive tape, and scissors. You are not in a CBRN environment.

**Standards:** Select and apply an appropriate bandage and wrap without causing further injury to the patient.

### Performance Steps

1. Select the appropriate bandaging material for the injury.

*NOTE:* The width of the bandage to use is determined by the size of the part to be covered. As a general rule, the larger the part or area, the wider the bandage.

- a. Use gauze or a flex roller for bleeding injuries of the forearm, upper arm, thigh, and lower leg.

- b. Use a flexible roller gauze bandage for bleeding injuries of the hand, wrist, elbow, shoulder, groin, knee, ankle, and foot.

- c. Use an elastic roller bandage for amputations, arterial bleeding, sprains, and torn muscles.

- (1) Hand-2 inch bandage.

- (2) Lower arm, lower leg, and foot-3 inch bandage.

- (3) Thigh and chest-4 to 6 inch bandage.

*NOTE:* Elastic roller bandages may be used wherever pressure support or restriction of movement is needed. They should not be used to secure dressings.

2. Prepare the patient for bandaging.

- a. Position the body part to be bandaged in a normal resting position (position of function).

*NOTE:* Bending a bandaged joint changes the pressure of the bandage in places of stress (elbow, knee, and ankle).

- b. Ensure that the body part to be bandaged is clean and dry.

- c. Place pads over bony places or between skin surfaces to be bandaged (such as fingers and armpits).

**CAUTION:** Do not wrap too tightly. The roller bandage may act as a tourniquet on an injured limb, causing further damage.

3. Apply the anchor wrap.

- a. Lay the bandage end at an angle across the area to be bandaged.

- b. Bring the bandage under the area, back to the starting point, and make a second turn.

- c. Fold the uncovered triangle of the bandage end back over the second turn.

- d. Cover the triangle with a third turn, completing the anchor.

4. Apply the bandage wrap to the injury.

- a. Use a circular wrap to end other bandage patterns, such as a pressure bandage, or to cover small dressings.
- b. Use a spiral wrap for a large cylindrical area such as a forearm, upper arm, calf, or thigh. The spiral wrap is used to cover an area larger than a circular wrap can cover.
- c. Use a spiral reverse wrap to cover small to large conical areas, for example, from ankle to knee.
- d. Use a figure eight wrap to support or limit joint movement at the hand, elbow, knee, ankle, or foot.
- e. Use a spica wrap (same as the figure eight wrap) to cover a much larger area such as the hip or shoulder.
- f. Use a recurrent wrap for anchoring a dressing on fingers, the head, or on a stump.

*NOTE:* Bandage width depends on the site: 1 inch wide for fingers and 3, 4, or 6 inches wide for the stump or head.

5. Check circulation after application of the bandage.
  - a. Check the pulse distal to the injury.
  - b. Check for capillary refill (<2 seconds is normal), if applicable.
  - c. Inspect the skin below the bandaging for discoloration.
  - d. Ask the patient if any numbness, coldness, or tingling sensations are felt in the bandaged part.
  - e. Remove and reapply the bandage, if necessary.
6. Check for irritation.
  - a. Ask the patient if the bandage rubs.
  - b. Check for bandage wrinkles near the skin surface.
  - c. Check for red skin or sores (ulcers) when the bandage is removed.
  - d. Remove and reapply the bandage, if necessary.
7. Elevate injured extremities to reduce swelling (edema) and control bleeding, if appropriate.
8. Record the treatment given on the appropriate medical form.

**Evaluation Preparation:**

Setup: For training and evaluation, have another Soldier act as the patient. Tell the patient not to assist in any way. Provide the necessary elastic bandage and tape for the Soldier and designate the part the Soldier should apply the elastic bandage to.

Brief Soldier: Tell the Soldier to apply the elastic bandage.

<b>Performance Measures</b>	GO	NO GO
1 Selected the appropriate bandaging material.	_____	_____
2 Prepared the patient for bandaging.	_____	_____
3 Applied the anchor wrap.	_____	_____
4 Applied the bandage wrap.	_____	_____

- |   |  |       |       |
|---|--|-------|-------|
| 5 | Checked circulation after the bandage was applied. | _____ | _____ |
| 6 | Checked for irritation.                            | _____ | _____ |
| 7 | Elevated the injured extremity, if appropriate.    | _____ | _____ |
| 8 | Recorded the treatment given.                      | _____ | _____ |

**Evaluation Guidance:** Score each Soldier according to the performance measures. Unless otherwise stated in the task summary, the Soldier must pass all performance measures to be scored GO. If the Soldier fails any steps, show what was done wrong and how to do it correctly.

**References**

**Required**  
None

**Related**  
None



## Apply a Traction Splint

081-833-0141

**CAUTION:** All body fluids should be considered potentially infectious. Always observe body substance isolation (BSI) precautions by wearing gloves and eye protection as a minimal standard of protection.

**Conditions:** You encounter a casualty with a suspected femur fracture. All other more serious injuries have been assessed and treated. You must apply a traction splint; another Soldier is available to assist you. You will need a traction splint, long spine board, securing devices, padding material, and DD Form 1380 US Field Medical Card (FMC). You are not in a CBRN environment.

**Standards:** Apply the traction splint without restricting circulation. Immobilize the fracture and maintain traction throughout the procedure, minimizing the effects of the injury.

### Performance Steps

1. Check for signs of a femur fracture. With unresponsive casualties, you should attempt to identify the mechanism of injury (MOI).

a. Inspect the extremity for deformities, contusions, abrasions, punctures or penetrations, burns, tenderness, lacerations, and swelling (DCAP-BTLS).

**WARNING:** Do not use a traction splint for an injury close to or involving the knee, injury of the hip or pelvis, partial amputations or avulsions with bone separation, or lower leg or ankle injury.

b. Palpate for tenderness, instability, or crepitus (TIC) in the extremity.

2. Expose the injured leg. For example cut the trouser leg if necessary.

3. Assess the circulation, sensation, and motor function (CSM).

4. Direct the assistant to manually support and stabilize the injured leg.

5. Measure the traction splint on the uninjured leg. Place the traction splint beside the casualty's uninjured leg and adjust to the proper length.

a. Place the ring at the ischial tuberosity (next to the casualty's iliac crest).

b. Loosen the locking sleeve.

c. Extend the splint 8 to 12 inches beyond the casualty's foot.

d. Tighten the locking sleeve.

e. Open and adjust the four Velcro support straps, which should be positioned at the mid-thigh, above the knee, below the knee, and above the ankle.

6. Apply the ankle hitch about the casualty's ankle and foot.

a. Thread the ankle hitch under the casualty's ankle at the void created by the heel.

b. Place the lower edge of the ankle hitch even with the bottom of the heel.

c. Crisscross the side straps high on the instep.

d. Bring the crisscrossed straps down to meet the center strap and hold them in place.

**CAUTION:** Apply only enough traction to align the limb to fit into the splint. Do not attempt to align the fracture fragments anatomically. Once manual traction has been applied, it must remain constant until the traction splint has been put in place and is providing traction.

7. Direct the assistant to manually apply gentle longitudinal (in-line) traction to the ankle hitch and foot, while you support the leg at the site of the suspected injury (one hand above the site and one hand below the site) to support the fracture as traction is pulled and the leg is lifted.

8. Place the splint into position by sliding the splint under the injured leg.

*NOTE:* While applying gentle traction, the assistant may lift the casualty's leg far enough to fit the splint into place.

a. Pull the release ring on the ratchet and release the traction strap.

b. Move the splint between the assistant's legs so that it is aligned with the casualty's injured leg.

c. Move one hand from the fracture site and pull the splint from between the assistant's legs.

d. Slide the splint under the leg until the ischial ring is at the buttock.

*NOTE:* Make sure the splint is aligned with the leg.

e. When the splint is in place, position the hand back under the fracture site for stabilization only.

f. On the assistant's signal, lower the leg into the cradle of the splint while maintaining manual traction.

g. Extend and position the heel stand after the splint is in position under the leg.

9. Pad the groin area (cravat, Kerlix®, etc.) and fasten the ischial strap.

10. Apply mechanical traction.

a. Attach the rings from the ankle hitch to the "S" hook from the splint.

b. Tighten the ratchet mechanism by turning it clockwise.

c. Direct the assistant to alert you when mechanical traction is equal to their manual traction.

*NOTE:* Adequate traction has been applied when the injured leg is the same length as the other leg or the casualty feels relief.

11. Secure the Velcro® support straps. Direct the assistant to maintain manual stabilization until all four support straps are secure.

12. Reevaluate the ischial strap and ankle hitch.

13. Reassess the CSM.

14. Place the casualty securely on a long spine board to immobilize the hip.

15. Secure the splint to the long spine board to prevent movement of the splint (strapping, tape, etc.).

16. Document the procedure on a FMC.

### **Evaluation Preparation:**

Setup: For training and evaluation, have another Soldier act as the casualty. You will need another Soldier to act as an assistant. Describe a scenario that involves a femur fracture (parachute or vehicle accident, etc.). Tell the assisting Soldier to only perform those actions the Soldier being evaluated directs.

**CAUTION:** Do not allow the Soldiers to apply full traction to the casualty.

Brief Soldier: To test step 1, tell the Soldier to state the signs of a femur fracture. Tell the Soldier that the casualty has a femur fracture. Tell the Soldier to, using the assistant, apply a traction splint to the fractured femur and prepare the casualty for transport.

<b>Performance Measures</b>	<b>GO</b>	<b>NO GO</b>
1 Checked for signs of a femur fracture.	_____	_____
2 Exposed the injured leg.	_____	_____
3 Assessed the CSM.	_____	_____
4 Directed the assistant to manually support and stabilize the injured leg.	_____	_____
5 Measured the traction splint on the other extremity and adjusted the splint to the proper length.	_____	_____
6 Applied the ankle hitch about the casualty's ankle and foot.	_____	_____
7 Directed assistant to apply manual, in-line traction to the ankle hitch and foot.	_____	_____
8 Placed the splint into position under the injured leg.	_____	_____
9 Padded the groin area (cravat, Kerlix®, etc.) and fasten the ischial strap.	_____	_____
10 Applied mechanical traction.	_____	_____
11 Secured the Velcro® support straps.	_____	_____
12 Reevaluated the ischial strap and ankle hitch.	_____	_____
13 Reassessed the CSM.	_____	_____
14 Placed the casualty on a long spine board.	_____	_____
15 Secured the splint to the long spine board.	_____	_____
16 Documented the procedure on the FMC.	_____	_____

**Evaluation Guidance:** Score each Soldier according to the performance measures. Unless otherwise stated in the task summary, the Soldier must pass all performance measures to be scored GO. If the Soldier fails any steps, show what was done wrong and how to do it correctly.

#### References

**Required**  
DD Form 1380

**Related**  
None

## Perform an Examination of the Shoulder

081-833-0269

**Conditions:** You have a patient that requires a shoulder examination. You will have a physical examination table. You are not in a CBRN environment.

**Standards:** Perform a shoulder examination without causing injury to the patient.

### Performance Steps

1. Identify the patient.
2. Obtain the patient history.
  - a. Date of injury.
  - b. Mechanism of injury (MOI).
  - c. Location of pain, if any.
  - d. Is there any numbness or tingling in the arm/hand?
  - e. Ability to move the shoulder/arm/hand after the injury?
  - f. Was there immediate or delayed swelling? Is the shoulder hot to touch?
  - g. Does anything make the pain better or worse?
  - h. Prior surgical history/shoulder injuries.
3. Perform a physical examination of the shoulder.
  - a. Gait. Watch the patient walk and analyze the gait and arm/hand swing. Note any abnormalities.
  - b. Inspectio. Have the patient place one finger on the spot that hurts the most. Look for the following:
    - (1) Swelling.
    - (2) Erythema.
    - (3) Ecchymosis.
    - (4) Deformity.
    - (5) Compare the affected shoulder to the unaffected one.
  - c. Palpation-palpate.
    - (1) Bony prominences.
    - (2) Joint lines.
    - (3) Pulses-radial.
    - (4) Is there sensation in the arm?
  - d. Range of Motion (ROM)-Ask the patient to complete the range of motion movements, but you or the patient should never force a motion. Compare range of motion of the affected shoulder with the unaffected one.
    - (1) Flexion.
    - (2) Extension.

- (3) Abduction.
- (4) Adduction.
- (5) Inner Rotation.
- (6) Outer Rotation.

- 4. Document the history and physical examination findings.
- 5. Refer the patient to a medical officer for further workup.

**Evaluation Preparation:**

Setup: For training and evaluation, use another Soldier to simulate the patient.

Brief Soldier: Tell the Soldier the simulated patient requires a shoulder examination.

<b>Performance Measures</b>	GO	NO GO
1 Identified the patient.	_____	_____
2 Obtained a patient history.	_____	_____
3 Performed a physical examination of the shoulder.	_____	_____
4 Documented the history and physical examination findings.	_____	_____
5 Referred the patient to a medical officer for further evaluation.	_____	_____

**Evaluation Guidance:** Score each Soldier according to the performance measures in the evaluation guide. Unless otherwise stated in the task summary, the Soldier must pass all performance measures to be scored GO. If the Soldier fails any step, show what was done wrong and how to do it correctly.

**References**

**Required**  
None

**Related**  
Physical Examination of the Spine and Extremities

## Perform an Examination of the Wrist

081-833-0273

**Conditions:** You have a patient that requires wrist examination. You will have a physical examination table. You are not in a CBRN environment.

**Standards:** Perform a wrist examination without causing injury to the patient.

### Performance Steps

1. Identify the patient.
2. Obtain the patient history.
  - a. Date of injury.
  - b. Mechanism of injury (MOI).
  - c. Location of pain, if any.
  - d. Is there any numbness or tingling in the hand?
  - e. Ability to move the arm/hand after the injury?
  - f. Was there immediate or delayed swelling? Is the wrist hot to the touch?
  - g. Does anything make the pain better or worse?
  - h. Prior surgical history/ wrist injuries.
3. Perform a physical examination of the wrist.
  - a. Gait. Watch the patient walk and analyze the gait and arm/hand swing. Note any abnormalities.
  - b. Inspection. Have the patient place one finger on the spot that hurts the most. Look for the following:
    - (1) Swelling.
    - (2) Erythema.
    - (3) Ecchymosis.
    - (4) Deformity.
    - (5) Compare the affected wrist and hand to the unaffected one.
  - c. Palpation-palpate.
    - (1) Bony prominences.
    - (2) Joint lines.
    - (3) Pulses-radial.
    - (4) Is there sensation in the hand?
  - d. Range of Motion (ROM). Ask the patient to complete the range of motion movements, but you or the patient should never force a motion. Compare range of motion of the affected wrist with the unaffected one.
    - (1) Flexion.
    - (2) Extension.

(3) Radial flexion.

(4) Ulnar flexion.

4. Document the history and physical examination findings.

5. Refer the patient to a medical officer for further workup.

**Evaluation Preparation:**

Setup: For training and evaluation, use another Soldier to simulate the patient.

Brief Soldier: Tell the Soldier the simulated patient requires wrist examination.

**Performance Measures**

	GO	NO GO
1 Identified the patient.	_____	_____
2 Obtained a patient history.	_____	_____
3 Performed a physical examination of the wrist.	_____	_____
4 Documented the history and physical examination findings.	_____	_____
5 Referred the patient to a medical officer for further evaluation.	_____	_____

**Evaluation Guidance:** Score each Soldier according to the performance measures in the evaluation guide. Unless otherwise stated in the task summary, the Soldier must pass all performance measures to be scored GO. If the Soldier fails any step, show what was done wrong and how to do it correctly.

**References**

**Required**

None

**Related**

Physical Examination of the Spine and Extremities

## Perform an Examination of the Hip

081-833-0274

**Conditions:** You have a patient that requires a hip examination. You will have a physical examination table. You are not in a CBRN environment.

**Standards:** Perform an examination of the hips without causing injury to the patient.

### Performance Steps

1. Identify the patient.
2. Obtain the patient history.
  - a. Date of injury.
  - b. Mechanism of injury (MOI).
  - c. Location of pain, if any.
  - d. Ability to walk after the injury?
  - e. Any numbness, tingling or weakness in the lower extremities?
  - f. Does anything make the pain better or worse?
  - g. Prior surgical history/hip injuries.
3. Perform a physical examination of the hip.
  - a. Gait-Watch the patient walk, if able. Note any abnormalities.
  - b. Inspection-Have the patient place one finger on the spot that hurts the most. Look for the following:
    - (1) Swelling.
    - (2) Erythema.
    - (3) Ecchymosis.
    - (4) Deformity.
  - c. Palpation-palpate.
    - (1) Tenderness.
    - (2) Crepitus.
    - (3) Abnormal masses.
  - d. Range of Motion (ROM). Ask the patient to complete the range of motion movements, but you or the patient should never force a motion. Compare the affected hip with the unaffected hip.
    - (1) Flexion.
    - (2) Extension.
    - (3) Abduction.
    - (4) Adduction.
4. Document the history and physical examination findings.
5. Refer the patient to a medical officer for further evaluation.



**Evaluation Preparation:**

Setup: For training and evaluation, use another Soldier to simulate the patient.

Brief Soldier: Tell the Soldier the simulated patient requires a hip examination.

<b>Performance Measures</b>	GO	NO GO
1 Identified the patient.	_____	_____
2 Obtained a patient history.	_____	_____
3 Performed a physical examination of the hip.	_____	_____
4 Documented the history and physical examination findings.	_____	_____
5 Referred the patient to a medical officer for further evaluation.	_____	_____

**Evaluation Guidance:** Score each Soldier according to the performance measures in the evaluation guide. Unless otherwise stated in the task summary, the Soldier must pass all performance measures to be scored GO. If the Soldier fails any step, show what was done wrong and how to do it correctly.

**References**

**Required**  
None

**Related**  
Physical Examination of the Spine and Extremities

## Apply a Sling and Swath

081-833-0265

**Conditions:** You have a casualty who needs a sling and swath. You have treated all other apparent life threats. You have performed a patient care hand wash and taken body substance isolation (BSI) precautions. You will need, clean cloth, clean cravat bandages, clean bulky dressing for padding, safety pins, pen, and DD Form 1380 US Field Medical Card (FMC). You are not in a CBRN environment.

**Standards:** Apply a sling and swath without causing further injury to the casualty.

**NOTE:** A sling is a triangular bandage used to support the shoulder and arm. Once the casualty's arm is placed in a sling, a swath can be used to hold the arm against the side of the chest.

### Performance Steps

1. Assess distal circulation, sensation, and motor (CSM) functions of the extremity.
2. Prepare the sling by folding cloth into a triangle.

**NOTE:** A triangular bandage makes an ideal arm sling.

3. Fold the injured arm across the casualty's chest.

**NOTE:** If casualty cannot hold their arm, have someone assist them until you tie the sling.

4. Position the sling over the top of the casualty's chest.
5. Extend one point of the triangle beyond the elbow on the injured side.
  - a. Take the bottom point and bring it up over the casualty's arm.
  - b. Continue to take it over the top of the injured shoulder.
  - c. If appropriate, draw up the ends of the sling so that the casualty's hand is about 4 inches above the elbow.

**CAUTION:** If a spinal injury is suspected, do not tie the sling around the casualty's neck, instead, pin the ends to the casualty's clothing securely.

6. Tie the two ends of the sling together.
  - a. Make sure that the knot does not press against the back of the casualty's neck.
  - b. Pad with bulky dressings.
  - c. Confirm the casualty's fingertips are left exposed.
7. Assess distal CSM.
  - a. If the pulse has been lost, take off the sling and repeat the procedure.
  - b. If procedure was repeated, recheck CSM.
8. Form a pocket for the casualty's elbow.
  - a. Take hold of the point of material at the elbow and fold it forward, pinning it to the front of the sling.
  - b. If you do not have a pin, twist the excess material and tie a knot in the point.
9. Form a swath from a second piece of material by tying it around the chest and the injured arm, over the sling.

*NOTE:* Do not place it over the casualty's arm on the uninjured side.

10. Reassess distal CSM functions of the extremity.
11. Monitor casualty until evacuation.
12. Record procedure on FMC.

**Evaluation Preparation:**

Setup: For training and evaluation, use another Soldier as the simulated casualty.

Brief Soldier: Tell the Soldier the simulated casualty requires a sling and swathe to be placed.

<b>Performance Measures</b>	GO	NO GO
1 Assessed distal circulation, sensation and motor (CSM) functions of the extremity.	_____	_____
2 Prepared the sling by folding cloth into a triangle.	_____	_____
3 Folded the injured arm across the casualty's chest.	_____	_____
4 Positioned the sling over the top of the casualty's chest.	_____	_____
5 Extended one point of the triangle beyond the elbow on the injured side.	_____	_____
6 Tied the two ends of the sling together.	_____	_____
7 Assessed distal CSM.	_____	_____
8 Formed a pocket for the casualty's elbow.	_____	_____
9 Formed a swath from a second piece of material by tying it around the chest and injured arm over the sling.	_____	_____
10 Reassessed distal CSM functions of the extremity.	_____	_____
11 Monitored casualty until evacuation.	_____	_____
12 Recorded procedure on the FMC.	_____	_____

**Evaluation Guidance:** Score each Soldier according to the performance measures. Unless otherwise stated in the task summary, the Soldier must pass all performance measures to be scored GO. If the Soldier fails any steps, show what was done wrong and how to do it correctly.

**References**

**Required**  
DD Form 1380

**Related**  
None

## Provide Care for a Casualty with a Suspected Spinal Injury

081-833-0267

**CAUTION:** All body fluids should be considered potentially infectious. Always observe body substance isolation (BSI) precautions by wearing gloves and eye protection as a minimal standard of protection.

**Conditions:** You encounter a casualty with a suspected spinal injury. All other more serious injuries have been assessed and treated. Three other Soldiers are available for assistance. You have taken BSI (body substance isolation) precautions. You will need straps, cravats, long and short spine boards, immobilization vest-type device, cervical collar or materials to improvise a cervical collar, padding materials, towels, blankets, head supports, pen and DD Form 1380 US Field Medical Card (FMC). You are not in a CBRN environment.

**Standards:** Complete all of the steps necessary to immobilize a casualty with a suspected spinal injury and prepare him for transport without causing additional injury to the casualty.

### Performance Steps

1. Inform casualty to not move and explain procedure prior to performing.

*NOTE:* An important factor to consider in the casualty with a possible spine injury is the mental status.

2. Provide manual in-line stabilization.

- a. Ask one of the Soldiers available for assistance.

**WARNING:** Manual in-line stabilization should not be released until the casualty is immobilized onto the long spine board.

- b. Instruct Soldier to manually hold in-line spinal stabilization and to not let go.

*NOTE:* In-line neutral position that is, the casualty's head should be facing forward and not turned to either side nor tilted forward or backward. You must be careful not to pull or twist the casualty's head but rather to hold it perfectly still and to remind the casualty not to try to move it. **WARNING:** If you suspect the casualty has a spinal injury, you must treat him as though he has a spinal injury; when in doubt, immobilize.

3. Check for the signs and symptoms of a spinal injury. With unresponsive casualties, you should attempt to identify the mechanism of injury (MOI).

- a. If possible, inspect the spine for deformities, contusions, abrasions, punctures or penetrations, burns, tenderness, lacerations, and swelling (DCAP-BTLS).

- b. Lacerations and/or contusions in the spinal region indicate severe trauma and usually accompany a spinal injury.

- c. Palpate for tenderness, instability, or crepitus (TIC) in the spinal region.

*NOTE:* The ability to walk, move the extremities, feel sensation, and the absence of pain does not necessary rule out a spinal cord injury.

- (1) Carefully insert your hand under the casualty's neck and palpate along the cervical spine as far as can be done without moving the casualty.

- (2) Carefully insert your hand into the area of the small of the back and palpate along the thoracic spine and down the lumbar spine as far as possible without moving the casualty.

- d. Check for weakness, loss of sensation, paresthesia (tingling), and/or paralysis.

- (1) A cervical spine injury may cause numbness or paralysis in all four extremities.
  - (2) A waist level (thoracic) spinal injury may cause numbness or paralysis below the waist.
  - (3) Ask the casualty to try to move his fingers and toes to check for motor function.
4. Immobilize a sitting casualty using a short spine board.
- a. Have your assistant carefully move the casualty's head into a proper, neutral in-line position. Continue manual stabilization until the casualty is secured to a long spine board. Whenever possible, kneel behind the casualty and place hands around the base of the skull on either side. Careful movement of the head and neck into a neutral position must be stopped if movement results in any of the following.
    - (1) Neck muscle spasm.
    - (2) Increased pain.
    - (3) Increase in numbness, tingling, or loss of motor ability.
    - (4) Compromise of the airway or ventilation.
  - b. In these situations, the casualty's head must be immobilized in the position in which it was initially found.
  - c. Stabilize the head and neck.
    - (1) Place your hands on both sides of the casualty's skull, with the palms above the ears.
    - (2) Support the jaw (mandible) with the fingers.
    - (3) Maintain manual stabilization until directed to release the stabilization.
  - d. Assess circulation, motor, and sensory function (CMS).
  - e. Apply a rigid cervical collar, if available, or improvise one.
 

*NOTE:* Measure the rigid cervical collar according to the manufacturer's specifications. (See task 081-833-0177.) An improperly sized device has a potential for further injury.
  - f. Push the board as far into the area behind the casualty as possible.
  - g. Tilt the upper end of the board toward the head.
  - h. Direct the assistant to position the back of the casualty's head against the board, maintaining manual in-line stabilization, by moving the head and neck as one unit.
 

*NOTE:* If the cervical collar or improvised collar does not fit flush with the spine board, place a roll in the hollow space between the neck and board. The roll should only be large enough to fill the gap, not to exert pressure on the neck.
  - i. Secure the short spine board to the casualty's torso.
    - (1) Place the buckle of the first strap in the casualty's lap.
    - (2) Pass the other end of the strap through the lower hole in the board, up the back of the board, through the top hole, under the armpit, over the shoulder, and across the back of the board at the neck.
    - (3) Buckle the second strap to the first strap and place the buckle on the side of the board at the neck.
    - (4) Pass the other end over the shoulder, under the armpit, through the top hole in the board, down the back of the board, through the lower hole, and across the lap. Secure it by buckling it to the first strap.

- j. Secure the casualty's head and head supports to the board with straps or cravats.

**WARNING:** Ensure that the cravats or head straps are firmly in place before the assistant releases stabilization.

- (1) Apply head supports.
- (2) Use two rolled towels, blankets, or similar material.
- (3) Place one close to each side of the head.
- (4) Using a cravat-like material across the forehead, make the supports and head one unit by tying to the board.

- k. Reassess CMS.

- l. Tie the casualty's hands together and place them in his lap.

*NOTE:* When positioning a casualty who is secured to a short spine board, on a long spine board, line up the hand grip holes of the short spine board with the holes of the long spine board, if possible, and secure the two boards together with straps.

5. Immobilize a sitting casualty using a vest-type device, such as a Kendrick extrication device (KED).

- a. Stabilize and assess the sitting casualty as in steps 4a through 4e.

*NOTE:* Before placing the vest-type device behind the casualty, the two long straps (groin straps) are unfastened and placed behind the device.

- b. Position the immobilization device behind the casualty. The side flaps are placed around the casualty's torso and moved until they are in contact with the casualty's armpits.

- c. Secure the vest-type device to the casualty's torso.

- (1) Immobilize the torso, beginning with the middle strap, followed by the lower strap and finally the upper strap. Tighten each strap after attachment.

- (2) Position and tighten each groin strap; ensure you pad the groin area.

**CAUTION:** The straps must be tight enough so the device does not move up, down, left or right excessively, but not so tight as to restrict the casualty's breathing.

- d. Secure the casualty's head to the vest-type device.

- (1) Pad behind the casualty's head as necessary.

- (2) Place the first strap or cravat across the chin angling upward toward the ear. Attach to the head flaps on either side of the head. Ensure the strap/cravat does not interfere with the airway.

- (3) Place the second strap or cravat across the forehead angling downward toward the base of the head. Attach to the head flaps on either side of the head.

*NOTE:* The pelvic straps must be released after being placed on a long spine board in order to place the casualty in a supine position.

- 6. Place the casualty on a long spine board.

*NOTE:* If a long spine board is not available, utilize a standard litter or improvised litter made from a board or door. A hard surface is preferable to one that gives with the casualty's weight.

- a. The log-roll technique.

- (1) Position the long spine board next to, and parallel with, the casualty.

(2) Maintain manual stabilization of the casualty's head and neck. This individual will direct all movements while maintaining in-line support of the head and neck.

(a) Spread your fingers and thumbs around the sides of the casualty's head to hold it steady.

(b) Support the jaw (mandible) with the fingers.

(c) Maintain manual stabilization until the casualty has been placed on the spine board.

(3) Apply a cervical collar, if available, or improvise one.

(4) Brief each of the three assistants on their duties and instruct them to kneel on the same side of the casualty, with the long spine board on the opposite side of the casualty.

(a) First assistant. Place the near hand on the shoulder and the far hand on the waist.

(b) Second assistant. Place the near hand on the hip and the far hand on the thigh.

(c) Third assistant. Place the near hand on the knee and the far hand on the ankle.

(5) On the command of the team leader stabilizing the casualty's head, and in unison, the assistants roll the casualty slightly toward them. The head and neck must be maintained in-line with the casualty's spine during all movements.

(6) Instruct the assistants to reach across the casualty with one hand, grasp the spine board at its closest edge, and slide it against the casualty. Instruct the number two assistant to reach across the board to the far edge and hold it in place to prevent board movement.

(7) Instruct the assistants to slowly roll the casualty back onto the board, keeping the head and spine in a straight line.

(8) Reassess CMS.

b. The straddle-slide technique.

**NOTE:** Use this method when limited space makes it impossible to use the log roll technique.

(1) Stand (team leader) at the head of the casualty with your feet wide apart.

(2) Apply stabilization to the casualty's head and apply a cervical collar, if available, or improvise one.

(3) Instruct the first assistant to stand behind you (facing your back), to line up the spine board, and to gently slide the spine board under the casualty at your command.

(4) Instruct the second assistant to straddle the casualty while facing you and gently elevate the shoulders so that the spine board can be slid under them.

(5) Instruct the third assistant (facing you) to carefully elevate the hips while the spine board is being slid under the casualty.

**WARNING:** Complete all movements simultaneously, keeping the head and spine in a straight line.

(6) Instruct the fourth assistant (facing you) to carefully elevate the legs and ankles while the board is being slid into place under the casualty.

**NOTE:** If the cervical collar or improvised collar does not fit flush with the spine board, place a roll in the hollow space between the neck and board. The roll should only be large enough to fill the gap, not to exert pressure on the neck.

7. Secure the casualty to the long spine board.

- a. While maintaining manual stabilization, secure the torso to the long spine board by applying straps across chest, pelvis, and legs. Adjust these straps as needed.
  - b. While continuing to maintain manual stabilization, apply the head supports to each side of the casualty's head.
  - c. Fasten a strap or cravat-like material tightly over the head supports and the lower forehead. A second strap/cravat is placed over the pads and the rigid cervical collar and is fastened securely to the long board.
  - d. Reassess CMS.
8. Record the treatment on the FMC.
  9. Evacuate the casualty.

**Evaluation Preparation:**

Setup: For training and evaluation, have another Soldier act as the casualty. You will need three Soldiers to act as the assistants. The Soldier being tested is to act as the team leader and direct the actions of the assistants. The casualty may be placed in a vehicle or other scenario, depending on available resources and the technique you are testing. Tell the assisting Soldiers to only perform those actions the Soldier being evaluated directs.

Brief Soldier: To test step 3, tell the Soldier to state the signs and symptoms of a spinal injury. Tell the Soldier that the casualty has a suspected spinal injury. Then tell the Soldier to position the casualty on a spine board and to direct the actions of the assistants.

<b>Performance Measures</b>	GO	NO GO
1 Instructed casualty not to move and explained procedure prior to performing.	_____	_____
2 Provided manual in-line stabilization.	_____	_____
3 Checked for signs and symptoms of a spinal injury.	_____	_____
4 Immobilized a sitting casualty using a short spine board.	_____	_____
5 Immobilized a sitting casualty using a vest-type device, such as a Kendrick Extrication Device.	_____	_____
6 Placed the casualty on the long spine board.	_____	_____
7 Secured the casualty on the long spine board.	_____	_____
8 Recorded the treatment on the FMC.	_____	_____
9 Evacuated the casualty.	_____	_____

**Evaluation Guidance:** Score each Soldier according to the performance measures in the evaluation guide. Unless otherwise stated in the task summary, the Soldier must pass all performance measures to be scored GO. If the Soldier fails any step, show what was done wrong and how to do it correctly.

**References**

**Required**  
DD Form 1380

**Related**  
None



## Perform an Examination of the Knee

**081-833-0268**

**Conditions:** You have a patient that requires a knee examination. You will have a physical examination table. You are not in a CBRN environment.

**Standards:** Perform a knee examination without causing injury to the patient.

### Performance Steps

1. Identify the patient.
2. Obtain the patient history.
  - a. Date of injury.
  - b. Mechanism of injury (MOI).
  - c. Location of pain, if any.
  - d. Was a pop or snap heard/felt?
  - e. Was there any locking of the knee?
  - f. Ability to walk after the injury?
  - g. Was there immediate or delayed swelling? Is the knee hot to the touch?
  - h. Does anything make the pain better or worse?
  - i. Prior surgical history/ knee injuries.
3. Perform a physical examination of the knee.
  - a. Gait-watch the patient walk, if able. Note any abnormalities.
  - b. Inspection-Have the patient place one finger on the spot that hurts the most. Look for the following:
    - (1) Swelling.
    - (2) Erythema.
    - (3) Deformity.
    - (4) Compare the affected extremity to the unaffected one.
  - c. Palpation-palpate.
    - (1) Joint lines-medial and lateral.
    - (2) Ligaments-medial collateral, lateral collateral.
    - (3) Patella.
    - (4) Pulses distal to the knees-anterior tibialis, dorsalis pedis.
    - (5) Is there sensation distal to the injury?
  - d. Range of Motion (ROM). Ask the patient to complete the range of motion movements, but you or the patient should never force a motion. Compare range of motion of the affected knee with the unaffected one.
    - (1) Flexion.

(2) Extension.

4. Document the history and physical examination findings.
5. Refer the patient to a medical officer for further evaluation.

**Evaluation Preparation:**

Setup: For training and evaluation, use another Soldier to simulate the patient.

Brief Soldier: Tell the Soldier the simulated patient requires a knee examination.

<b>Performance Measures</b>	<b>GO</b>	<b>NO GO</b>
1 Identified the patient.	_____	_____
2 Obtained a patient history.	_____	_____
3 Performed a physical examination of the knee.	_____	_____
4 Documented the history and physical examination findings.	_____	_____
5 Referred the patient to a medical officer for further evaluation.	_____	_____

**Evaluation Guidance:** Score each Soldier according to the performance measures in the evaluation guide. Unless otherwise stated in the task summary, the Soldier must pass all performance measures to be scored GO. If the Soldier fails any step, show what was done wrong and how to do it correctly.

**References**

**Required**

None

**Related**

Physical Examination of the Spine and Extremities

## Perform an Examination of the Ankle

081-833-0272

**Conditions:** You have a patient that requires an ankle examination. You will have a physical examination table. You are not in a CBRN environment.

**Standards:** Perform an ankle examination without causing injury to the patient.

### Performance Steps

1. Identify the patient.
2. Obtain the patient history.
  - a. Date of injury.
  - b. Mechanism of injury (MOI).
  - c. Location of pain, if any.
  - d. Was a pop or snap heard/felt?
  - e. Ability to walk after the injury?
  - f. Was there immediate or delayed swelling? Is the ankle hot to the touch?
  - g. Does anything make the pain better or worse?
  - h. Prior surgical history/ankle injuries.
3. Perform a physical examination of the ankle.
  - a. Gait-Watch the patient walk, if able. Note any abnormalities.
  - b. Inspection-Have the patient place one finger on the spot that hurts the most. Look for the following:
    - (1) Swelling.
    - (2) Erythema.
    - (3) Ecchymosis.
    - (4) Deformity.
    - (5) Compare the affected extremity to the unaffected one.
  - c. Palpation-palpate.
    - (1) Bony prominences.
    - (2) Medial and lateral malleolus.
    - (3) Pulses-anterior tibialis, dorsalis pedis.
    - (4) Is there sensation distal to the injury?
  - d. Range of Motion (ROM). Ask the patient to complete the range of motion movements, but you or the patient should never force a motion. Compare range of motion of the affected ankle with the unaffected one.
    - (1) Dorsiflexion.
    - (2) Plantarflexion.

4. Document the history and physical examination findings.
5. Refer the patient to a medical officer for further workup.

**Evaluation Preparation:**

Setup: For training and evaluation, use another Soldier to simulate the patient.

Brief Soldier: Tell the Soldier the simulated patient requires an ankle examination.

<b>Performance Measures</b>	<b>GO</b>	<b>NO GO</b>
1 Identified the patient.	_____	_____
2 Obtained a patient history.	_____	_____
3 Performed a physical examination of the ankle.	_____	_____
4 Documented the history and physical examination findings.	_____	_____
5 Referred the patient to a medical officer for further evaluation.	_____	_____

**Evaluation Guidance:** Score each Soldier according to the performance measures in the evaluation guide. Unless otherwise stated in the task summary, the Soldier must pass all performance measures to be scored GO. If the Soldier fails any step, show what was done wrong and how to do it correctly.

**References**

**Required**  
None

**Related**  
Physical Examination of the Spine and Extremities

## Immobilize the Pelvis

**081-833-0266**

**WARNING:** Certain pelvic fractures can cause significant internal hemorrhaging. Many times when casualties experience pelvic fractures, there are also significant internal injuries to the organs protected by the pelvis. Hemodynamic stability and rapid transport should be a main consideration when treating these types of casualties.

**Conditions:** You have a casualty with a suspected dislocated or fractured hip or pelvis. You need to immobilize the hip and pelvis. Three other Soldiers are available to assist you. You will need a litter, cravats or commercial straps, padding material, spine board or other rigid object, pneumatic anti-shock garment (PASG) or a pelvic binder device (pelvic sling) and a scoop stretcher. You are not in a CBRN environment. You have taken body substance isolation (BSI).

**Standards:** Immobilize a suspected dislocated or fractured hip or pelvis without impairing circulation or causing further injury to the casualty.

*NOTE:* Pain control should be considered early when managing hip or pelvic injuries.

### Performance Steps

**CAUTION:** Both a dislocated and a fractured hip or pelvis are accompanied by considerable pain. The casualty will resist any movement because of pain. It is essential that medical personnel take all possible precautions, using the best available materials at hand while preparing the casualty to be immediately evacuated.

1. Check for the signs and symptoms of a hip or pelvic injury.
  - a. Anterior hip dislocation.

*NOTE:* Anterior dislocation is very rare and is caused by the legs suddenly being forced widely apart and locked in this position.

- (1) Hip pain.
  - (2) Severe deformity of the affected leg.
    - (a) The knee is turned outward.
    - (b) The affected leg is shortened.
    - (c) The hip is drawn away from the midline of the body.
    - (d) The leg has rotated away from the midline of the body.
  - (3) Impaired circulation in the affected extremity.
    - (a) Loss of pulse distal to the injury.
    - (b) Coolness and/or cyanosis.
    - (c) Swelling due to internal blood loss.

**WARNING:** Significant blood loss may occur before swelling is evident. Take the casualty's vital signs as soon as possible and monitor them during stabilization and transport.

- (d) Hypovolemic shock.
- (4) Impaired sensation in the affected extremity.
  - (a) Tingling or other abnormal sensations (paresthesia).

(b) Loss of sensation.

b. Posterior hip dislocation.

*NOTE:* Posterior dislocation is the most common type of hip dislocation.

(1) Hip pain.

(2) Severe deformity of the affected leg.

(a) The hip joint is flexed with the knee drawn up.

(b) The hip is drawn toward the midline of the body.

(c) The leg has rotated toward the midline of the body.

(3) Impaired circulation in the affected extremity.

(a) Loss of pulse distal to the injury.

(b) Coolness and/or cyanosis.

(c) Swelling due to internal blood loss.

(4) Impaired sensation in the affected extremity.

(a) Paresthesia.

(b) Loss of sensation.

*NOTE:* Weakness of muscles that raise the foot may occur. This condition, known as "foot drop," may be a sign of damage to the sciatic nerve.

c. Hip fracture.

*NOTE:* Some of the most common fractures are those that occur at the proximal (upper) end of the femur. These have been called "hip fractures" even though the hip joint is rarely involved.

(1) Hip pain.

(2) The casualty is unable to walk on or move the affected leg.

(3) Deformity.

(a) The affected leg has rotated toward the midline of the body.

(b) The affected leg will usually be shorter than the uninjured one.

*NOTE:* Fractures of the femur are often open. Whether closed or open, they are always associated with a loss of large amounts of blood. Therefore, you should treat the casualty with high-flow oxygen and monitor vital signs frequently, watching for signs of shock.

(4) Impaired circulation in the affected extremity.

(a) Loss of pulse in the femoral or popliteal arteries distal to the injury.

(b) Coolness and/or cyanosis.

(c) Swelling due to internal blood loss.

(5) Impaired sensation in the affected extremity.

(a) Paresthesia.

(b) Loss of sensation.

**WARNING:** Inspect the casualty's pelvis prior to palpation. When palpating the casualty's pelvis only gentle palpation should be used and the pelvis should only be palpated once. If upon physical inspection deformity, ecchymosis or edema is visible, palpation of the pelvis is not

necessary and a pelvic fracture should be suspected.

d. Pelvic fractures.

*NOTE:* There are three types of pelvic fractures, rami fractures, acetabular fractures and pelvic ring fractures. Pelvic ring fractures usually involve massive hemorrhage and are considered a life threat.

- (1) Pain.
- (2) Deformity.
- (3) Ecchymosis.

2. Check for circulation in the affected leg(s) by checking the femoral and popliteal pulses and observing for swelling or cyanosis.

3. Check for impaired sensation by asking the casualty if he has tingling, abnormal sensations, or loss of sensation in the affected limb.

**CAUTION:** Do not log roll a casualty with a hip injury onto the injured side. If available, place the casualty on a spine board using a scoop litter.

4. Immobilize the injury.

a. Hip dislocations.

- (1) Place the casualty on a long spine board. (See task 081-833-0181.)
- (2) Support the leg in its abnormal position using pillows, blankets, or similar material.
- (3) Secure the support material with cravats.

b. Hip fracture.

- (1) Place the casualty on a long spine board.
- (2) Place support material under the buttocks to reduce abdominal pain only if there are no other major fractures in the lower extremities.
- (3) Place bulky support material between the casualty's legs and strap them together.
- (4) Place bulky support material underneath the knees.

c. Pelvic fracture.

- (1) Place pneumatic anti-shock garment (PASG), on long spine board.
- (2) Gently apply the scoop stretcher to the casualty.
- (3) Move the casualty (on the scoop stretcher) to the long spine board and remove the scoop stretcher.
- (4) Wrap and secure the PASG to the casualty (do not inflate).

*NOTE:* The PASG is applied but not inflated until the casualty shows signs of hemodynamic instability (class III or IV shock). If PASGs are not available, a pelvic binder device or sheet should be applied.

- (5) The lower extremities should be adducted and internally rotated.
- (6) Secure the casualty to the long spine board.

5. Check for complications.

a. Impaired circulation in the affected limb.

- b. Neurological deficit.
- c. Hypovolemic shock.

**WARNING:** Spontaneous reduction of dislocation may occur during any movement. This may be accompanied by additional damage to nerves and blood vessels. The receiving facility must be informed if this occurs.

6. Record the treatment given on a FMC, aTCCC or a patient care report.

**WARNING:** Avoid any bumping or jerking during transport. Excessive movement of a fracture or dislocation can increase blood loss and pain. Hip and leg injuries allow for a greater area of pooling of blood that is not evident early on, and may result in the casualty going in to hypovolemic shock.

- 7. Evacuate the casualty.
  - a. Position the casualty and spine board on a litter.
  - b. Load litter on evacuation platform.

**Evaluation Preparation:**

Setup: For training and evaluation, use another Soldier as a simulated casualty and have three assistants available to assist.

Brief Soldier: Tell the Soldier the casualty has a suspected hip or pelvic injury that needs to be immobilized.

<b>Performance Measures</b>	GO	NO GO
1 Checked for the signs and symptoms of a hip or pelvic injury.	_____	_____
2 Checked for circulation in the affected leg(s).	_____	_____
3 Checked for impaired sensation.	_____	_____
4 Immobilized the injury.	_____	_____
5 Checked for complications.	_____	_____
6 Recorded the treatment given on a FMC, TCCC Card or patient care report.	_____	_____
7 Evacuated the casualty.	_____	_____

**Evaluation Guidance:** Score each Soldier according to the performance measures. Unless otherwise stated in the task summary, the Soldier must pass all performance measures to be scored GO. If the Soldier fails any steps, show what was done wrong and how to do it correctly.

**References**

<p><b>Required</b> DD Form 1380 DA Form 7656</p>	<p><b>Related</b> None</p>
--	--------------------------------



## Perform an Examination of the Elbow

**081-833-0270**

**Conditions:** You have a patient that requires an elbow examination. You will have a physical examination table. You are not in a CBRN environment.

**Standards:** Perform an elbow examination without causing injury to the patient.

### Performance Steps

1. Identify the patient.
2. Obtain the patient history.
  - a. Date of injury.
  - b. Mechanism of injury (MOI).
  - c. Location of pain, if any.
  - d. Was a pop or snap heard/felt?
  - e. Ability to move the arm after the injury?
  - f. Was there immediate or delayed swelling? Is the elbow hot to the touch?
  - g. Does anything make the pain better or worse?
  - h. Prior surgical history/ elbow injuries.
3. Perform a physical examination of the elbow.
  - a. Gait-Watch the patient walk and analyze the gait and arm swing. Note any abnormalities.
  - b. Inspection-Have the patient place one finger on the spot that hurts the most. Look for the following:
    - (1) Swelling.
    - (2) Erythema.
    - (3) Ecchymosis.
    - (4) Deformity.
    - (5) Compare the affected extremity to the unaffected one.
  - c. Palpation-palpate.
    - (1) Bony prominences.
    - (2) Joint lines.
    - (3) Pulses-radial.
    - (4) Is there sensation distal to the injury?
  - d. Range of Motion (ROM). Ask the patient to complete the range of motion movements, but you or the patient should never force a motion. Compare range of motion of the affected elbow with the unaffected one.
    - (1) Flexion.
    - (2) Extension.

4. Document the history and physical examination findings.
5. Refer the patient to a medical officer for further workup.

**Evaluation Preparation:**

Setup: For training and evaluation, use another Soldier to simulate the patient.

Brief Soldier: Tell the Soldier the simulated patient requires an elbow examination.

<b>Performance Measures</b>	<b>GO</b>	<b>NO GO</b>
1 Identified the patient.	_____	_____
2 Obtained a patient history.	_____	_____
3 Performed a physical examination of the elbow.	_____	_____
4 Documented the history and physical examination findings.	_____	_____
5 Referred the patient to a medical officer for further evaluation.	_____	_____

**Evaluation Guidance:** Score each Soldier according to the performance measures in the evaluation guide. Unless otherwise stated in the task summary, the Soldier must pass all performance measures to be scored GO. If the Soldier fails any step, show what was done wrong and how to do it correctly.

**References**

**Required**  
None

**Related**  
Physical Examination of the Spine and Extremities

## Perform an Examination of the Back

081-833-0271

**Conditions:** You have a patient that requires a back examination. You will have a physical examination table. You are not in a CBRN environment.

**Standards:** Perform a back examination without causing injury to the patient.

### Performance Steps

1. Identify the patient.
2. Obtain the patient history.
  - a. Date of injury.
  - b. Mechanism of injury (MOI).
  - c. Location of pain, if any.
  - d. Ability to walk after the injury?
  - e. Any numbness, tingling or weakness in the lower extremities?
  - f. Any bladder or bowel changes?
  - g. Does anything make the pain better or worse?
  - h. Any fever or night sweats?
  - i. Prior surgical history/back injuries.
3. Perform a physical examination of the back.
  - a. Gait-Watch the patient walk, if able. Note any abnormalities.
  - b. Inspection-Have the patient place one finger on the spot that hurts the most. Look for the following:
    - (1) Swelling.
    - (2) Erythema.
    - (3) Ecchymosis.
    - (4) Deformity.
  - c. Palpation-palpate.
    - (1) Tenderness.
    - (2) Crepitus.
    - (3) Abnormal masses.
  - d. Range of Motion (ROM). Ask the patient to complete the range of motion movements, but you or the patient should never force a motion.
    - (1) Flexion.
    - (2) Extension.
    - (3) Lateral bending.
    - (4) Rotation.

4. Document the history and physical examination findings.
5. Refer the patient to a medical officer for further evaluation.

**Evaluation Preparation:**

Setup: For training and evaluation, use another Soldier to simulate the patient.

Brief Soldier: Tell the Soldier the simulated patient requires a back examination.

<b>Performance Measures</b>	<b>GO</b>	<b>NO GO</b>
1 Identified the patient.	_____	_____
2 Obtained a patient history.	_____	_____
3 Performed a physical examination of the back.	_____	_____
4 Documented the history and physical examination findings.	_____	_____
5 Referred the patient to a medical officer for further evaluation.	_____	_____

**Evaluation Guidance:** Score each Soldier according to the performance measures in the evaluation guide. Unless otherwise stated in the task summary, the Soldier must pass all performance measures to be scored GO. If the Soldier fails any step, show what was done wrong and how to do it correctly.

**References**

**Required**  
None

**Related**  
Physical Examination of the Spine and Extremities

## Treat Common Musculoskeletal Disorders

**081-833-0222**

**Conditions:** You have a patient who presents with a musculoskeletal complaint. You will need a shoulder sling, splint, ace wrap, crutches anti-inflammatory drugs, ice packs, and patient's medical record. You are not in a CBRN environment.

**Standards:** Treat common musculoskeletal or foot complaints without causing further harm to the patient.

### Performance Steps

1. Review the patient's medical record, if available.
2. Obtain a history.
  - a. O = onset. When did it start? What were you doing when it started? What was the position of the foot (inverted, supinated)?
  - b. P = provocative and palliative factors. What makes it better? What makes it worse? Is there any pain without weight bearing?
  - c. Q = quality. Is it sharp, dull, aching, pounding, constant, or intermittent? What is the character of the pain?
  - d. R = region and radiation. Where exactly is the pain? Does it seem to spread anywhere or does it stay right there? Is there any involvement of other joints?
  - e. S = severity. How bad is the pain? Is it incapacitating? Does it cause you to change your activity?
  - f. T = time, temporal characteristics (duration). When does it hurt? How long does it last? Have you had prior episodes? Any history of trauma or prior surgery?
3. Manage cervical pain.
  - a. Cervical strain.
    - (1) A strain happens when a muscle-tendon unit is overloaded or stretched.
    - (2) Motion of the neck becomes painful.
    - (3) Peaks after several hours or the next day.
    - (4) Treat with non-steroidal anti-inflammatory drugs (NSAIDs), heat, massage, and other therapeutic modalities.
  - b. Cervical sprain.
    - (1) Movement is limited.
    - (2) Ligamentous disruption may be extensive enough to result in instability with associated neurologic involvement.
    - (3) Routine cervical spine radiographs are indicated.
    - (4) Treatment of a cervical sprain consists of immobilization, rest, support, and NSAIDs.
    - (5) Return to participation is permitted when motion and muscle strength normalize.
  - c. Cervical fracture. Any patient suspected of cervical fracture or having any neurologic deficit as a result of a cervical injury requires x-rays and must be evaluated by a medical officer.

4. Manage low back pain.

a. Lumbosacral strain (mild to moderate).

(1) Signs and symptoms.

- (a) Usually have reduced range of motion.
- (b) Discomfort which is localized to the lumbar-sacral area.
- (c) Palpable muscle tenderness/spasm.
- (d) Negative straight leg raise (SLR).

(2) Treatment. Decrease activity and ice massages. Medications, if required, usually consist of anti-inflammatory drugs and/or muscle relaxants. Often obesity is a factor in low back pain and patients should be encouraged to lose weight.

5. Manage shoulder pain.

a. Rotator cuff tear.

- (1) Usually presents with shoulder pain/tenderness.
- (2) History of trauma.
- (3) Patient is unable to abduct the arm or hold it abducted against gravity.
- (4) Treat initially with a shoulder sling and oral anti-inflammatory drugs (ASA, Motrin).

Any shoulder complaint with a history of trauma must be referred to a medical officer.

b. Impingement syndrome (shoulder pain).

(1) Most common cause of shoulder pain and refers to mechanical compression and/or wear of the rotator cuff tendons.

(2) Any process which compromises this normal gliding function may lead to mechanical impingement.

(3) Most commonly seen in tennis players, pitchers and swimmers.

(4) The first step in treating shoulder impingement is to eliminate any identifiable cause or contributing factor.

(5) Non-steroidal anti-inflammatory medication may be used.

(6) The mainstay of treatment involves exercises to restore normal flexibility and strength to the shoulder girdle.

c. Acute bursitis.

- (1) Usually produces pain with movement.
- (2) Follows overuse in most instances.
- (3) Most frequently tender to palpation over subdeltoid bursa.

(4) Treated with anti-inflammatory drugs and progressive shoulder exercises. There should be a reduction of certain physical activities including lifting, pushups and pulling for seven7 days.

d. Septic arthritis.

(1) Should be considered if the patient has a fever or other signs and symptoms of inflammation.

(2) Emergent referral to a medical officer is indicated.

e. Dislocation.

(1) Usually follows a history of trauma but may occur spontaneously in some people.

(2) Sudden onset of pain with gross deformity of shoulder joint.

(3) Severe limitation of motion.

(4) X-ray should be done to rule out (R/O) associated fracture if a history of trauma. Often deferred until after reduction in order not to delay.

(5) Splint and assess distal pulses.

(6) Prompt referral to a medical officer.

(7) Pain medication and/or muscle relaxant may be used to relieve anxiety, pain and muscle spasm prior to reducing.

6. Manage knee pain.

a. Septic knee joint.

(1) Hot, tender knee with or without swelling.

(2) Orthopedic emergency requiring referral to a medical officer.

b. Sprain/strain.

(1) Tenderness over medial collateral ligament (MCL) or lateral collateral ligament (LCL) without laxity may indicate grade I sprain or strain.

(2) If mild laxity and tenderness of MCL/LCL is present, possible grade II sprain.

(3) If ecchymosis, effusion present with laxity, possible grade III sprain (torn ligament).

(4) Initial treatment consists of ice packs, ace wrap and elevation for the first 24 hours. Crutches may be indicated for comfort. Anti-inflammatory agents are used as required.

c. Patellar dislocation. Gross instability of the patella indicates that injury to the soft tissues of the medial aspect of the knee has been extensive.

(1) When dislocation of the patella occurs alone, it may be caused by a direct force or activity of the quadriceps, and the direction of dislocation of the patella is usually lateral.

(2) Spontaneous reduction may occur if the knee joint is extended.

(3) Initially treat with rest, ice, compression, elevation (RICE), NSAID, profile, and crutches if unstable. Will need ortho referral to evaluate for arthroscopic surgery.

d. Retropatellar (patellofemoral) pain syndrome.

(1) ) The symptoms probably represent the majority of knee pain complaints in athletes.

(2) Vague knee pain, which is usually after several hours of exercise.

(3) Walking downhill or downstairs, bending at the knees, and kneeling exacerbates pain.

(4) Initially treat with RICE, NSAID, stretches and exercises to strengthen quadriceps. Physical therapy consult for prolonged cases.

7. Manage foot pain.

- a. Perform a physical examination (PE).
    - (1) Inspect the problem area.
    - (2) Determine the range of motion.
    - (3) Palpate the problem area.
    - (4) Check muscle strength.
  - b. Refer to a medical officer (MO) for x-rays of problem area, if appropriate and available.
  - c. Formulate assessment based upon history, PE and/or x-rays.
8. Manage ankle injuries.
- a. Grade I ankle sprain.
    - (1) Antalgic gait.
    - (2) Able to bear weight.
    - (3) Minimal edema.
    - (4) Mild tenderness of malleolar area.
    - (5) Negative drawer sign.
    - (6) Initially treated with ice, compression, and elevation for 24-48 hrs. Crutches are indicated for up to 48 hrs in grade I sprains. Anti-inflammatory agents (Motrin) and ace wrap protection are indicated for 5-7 days; with gradually increased exercises.
  - b. Grade II ankle sprain.
    - (1) Unable to bear weight.
    - (2) Edema.
    - (3) Possible ecchymosis.
    - (4) Acute tenderness.
    - (5) Negative drawer sign.
    - (6) Neurovascular status intact.
    - (7) Range of motion reduced.
    - (8) An x-ray should be done to rule out an associated fracture.
    - (9) May require posterior or "U" splinting for 3-5 days with ice, elevation, crutches and analgesics (Motrin). An ace wrap is indicated with gradual increase of activity after 72 to 96 hours.
  - c. Grade III ankle sprain.
    - (1) Unable to bear weight.
    - (2) Edema.
    - (3) Ecchymosis present.
    - (4) Acute tenderness.
    - (5) Positive drawer sign.
    - (6) Neurovascular status may be compromised.



(7) Range of motion markedly reduced.

(8) Should be referred to a MO for x-rays to be done to rule out an associated fracture.

(9) Immobilization using either a splint or non-weight bearing cast. Initially, ice, compression, and elevation are used to reduce edema and pain. Crutches, without weight bearing, and follow-up with podiatry or orthopedics is usually indicated. Non-steroidal anti-inflammatory drugs or a mild narcotic will often be needed for pain relief. In all sprains, physical activity must be reduced appropriately and will vary in length from 72 hours to several weeks.

9. Manage achilles tendonitis.

a. Pain, swelling, tenderness along tendon.

b. Treat achilles tendonitis with RICE, NSAIDs, ice for twenty minutes after activity, heel lift, and crutches if severe.

10. Manage metatarsalgia.

a. Pain under the metatarsals that is exacerbated with functional activities and may present as burning.

b. Commonly seen in women and in the second metatarsal.

c. Important to rule out stress fracture, neuroma, and avascular necrosis of the metatarsal head.

d. Conservative management is directed at relieving the pressure beneath the area of maximum pain.

e. The patient should obtain a shoe of appropriate style and adequate size to allow an orthotic device to be inserted.

11. Manage bunion.

a. Excessive bony growth (exostosis) on the head of the first metatarsal.

b. Callous formation and bursal inflammation.

c. The patient should be encouraged to wear shoes of adequate size and shape.

d. Pads may be placed in the first web space or over the median eminence to help take pressure off of a painful median eminence.

e. Pads are also may be placed underneath the metatarsal heads to take pressure off painful calluses or sesamoids.

f. Podiatric surgical intervention may be considered.

12. Manage plantar fasciitis.

a. Inflammation of plantar aponeurosis.

b. Tenderness along plantar fascia.

c. Treatment of pain 1-2 weeks in duration is with NSAIDs, rest, and stretches.

d. The patient should perform ice massages with a cold bottle under the arch after activity.

e. Over the counter insole arch support may help alleviate tension on the arch.

f. Chronic pain may require a podiatry consult.

13. Record all treatment in the patient's medical record.

**Evaluation Preparation:** None.

<b>Performance Measures</b>	GO	NO GO
1 Reviewed the patient's medical record if available.	_____	_____
2 Obtained history.	_____	_____
3 Managed cervical pain.	_____	_____
4 Managed low back pain.	_____	_____
5 Managed shoulder pain.	_____	_____
6 Managed knee pain.	_____	_____
7 Managed foot pain.	_____	_____
8 Managed ankle injuries.	_____	_____
9 Managed achilles tendonitis.	_____	_____
10 Managed metatarsalgia.	_____	_____
11 Managed bunion.	_____	_____
12 Managed plantar fasciitis.	_____	_____
13 Recorded all treatment in the patient's medical record.	_____	_____

**Evaluation Guidance:** Score each Soldier according to the performance measures. Unless otherwise stated in the task summary, the Soldier must pass all performance measures to be scored GO. If the Soldier fails any steps, show what was done wrong and how to do it correctly.

**References**

**Required**  
None

**Related**  
The Merck Manual of Diagnosis and Therapy

**Subject Area 8: CBRN**  
**Decontaminate a Casualty**  
**081-833-0095**

**Conditions:** You are supervising the contaminated side of an established chemical decontamination station. Medical personnel and nonmedical augmentees are in MOPP level 4. Chemically contaminated casualties have been triaged by the senior medic and have been routed to your area for decontamination. You will need a M258A1 or M291 decontamination kit, 5% chlorine solution, 0.5% chlorine solution, butyl rubber aprons, butyl rubber gloves, stainless steel buckets, cellulose sponges, water source, plastic bags, litters, litter stands, bandage scissors, M8 chemical detection paper, chemical agent monitor (CAM), contaminated disposal containers, bandages, gauze, combat application tourniquets (C-A-T) and DD Form 1380 US Field Medical Card (FMC). You are in a CBRN environment.

**Standards:** Remove the casualty's clothing without further contaminating the casualty or contaminating decontamination team personnel. Remove dressings, replace tourniquets, and decontaminate splints. Effectively decontaminate and transfer the casualty across the shuffle pit without contaminating the clean side of the hot line.

*NOTE:* The supported unit must provide a minimum of 8 nonmedical personnel to augment the decontamination station as the decontamination team. Although casualty decontamination is routinely performed by these nonmedical personnel, the supervision of and final determination as to the completeness of the decontamination rests with medical personnel.

*NOTE:* Steps 1 through 17 will be performed by personnel in the clothing removal area. At the clothing removal area two to four persons will be working together as a team, one or two on either side of the casualty.

**Performance Steps**

1. Decontaminate the casualty's hood.

a. Cover the mask air inlets of the filter canister (C2A1) with a hand or gauze. Instruct the casualty to do this if he is able.

b. Wipe off the voicemitter, eyelets, outserts and the hood using M291 SDK or 5% bleach solution (starting at the top of the head and wiping down towards the litter and shoulders).

*NOTE:* The medical equipment set (MES) for chemical agent casualty decontamination contains powdered calcium hypochlorite (high test hypochlorite or HTH). It is mixed with water to make the 5% and 0.5% decontaminating solutions. Liquid chlorine bleach (household bleach), a 5% solution of sodium hypochlorite, may also be used.

c. Uncover the mask air inlets.

2. Cut off the casualty's hood.

a. Remove the quick-doff hood of the M40 mask.

(1) Dip cutting tools and gloved hands in the 5% solution.

(2) Cut the hood shoulder straps.

*NOTE:* After every complete segmental cut, the cutting tools are decontaminated, along with the gloved hands of the Soldier doing the cutting. Do this by dipping gloved hands and cutting tools in a bucket of 5% bleach, or if ample supplies of the M295 or, M291 are available, and water is limited, these can be used to scrub the cutting tools.

(3) Cut the neck cord, hood straps and drawstring.

(4) Cut the quick-doff hood from the front bottom center to the chin through the elastic band under the chin.

(5) Cut the hood straps that connect hood to the mask.

(6) Finally, cut from the center of the forehead, over the top of the head toward the litter, so that the hood will lay flat on the litter.

b. Remove the hood of the Joint Service Lightweight Integrated Suit Technology (JSLIST).

(1) Dip the cutting device in a bucket of 5% bleach solution or decon/scrub-cutting tool with the M295 or M291.

(2) Cut the hood starting at the front center and continue cutting across the top of the head toward the litter.

(3) Fold the left and right sides of the hood away from the head on the litter.

3. Decontaminate the casualty's mask and exposed skin.

a. Use soap and water, M291 skin decontamination kit, or 0.5% bleach solution.

**CAUTION:** Use only the 0.5% solution to decontaminate the skin and the parts of the mask that touch the face. The 5% solution is corrosive and may burn the skin.

b. Cover the port of filter canister to prevent wetting or congesting.

c. Decontaminate the exterior of the mask.

d. Wipe any exposed areas of Soldier's face that were not protected by the hood (i.e. chin, neck, and back of ears).

e. Uncover the mask air inlets.

4. Remove the casualty's FMC.

**NOTE:** The medic at the litter patient decontamination station should view the FMC prior to removal.

a. Cut the FMC tie-wire, allowing the FMC to fall into a plastic bag. If possible, do not allow any of the tie-wire to remain attached to the card. This will prevent the wire from poking a hole in the bag.

b. Seal the plastic bag and decontaminate the outside of the plastic bag with the 0.5% solution.

c. Place the plastic bag under the back of the Soldier's mask head harness straps.

5. Remove gross contamination on the overgarment by wiping all visible contamination spots with a sponge soaked in 5% solution.

6. Remove the casualty's protective battle dress overgarment (BDO)/JSLIST jacket by cutting.

**CAUTION:** Dip and scrub the cutting tool in the 5% solution before doing each cutting procedure to avoid contaminating the inner garment or the casualty's skin.

a. Unfasten/cut Velcro closure at the wrist.

b. Make two cuts, one up each sleeve from the wrist to the shoulder, and then to the collar. Keep the cuts close to the inside of the arms so that most of the sleeve material is folded outward.

**CAUTION:** Medical items are not removed at the clothing removal area. Cut around medical

items such as dressings, splints, and tourniquets.

c. Cut the jacket drawstring at the bottom of the jacket and unfasten Velcro® closures, moving from waist to neck, and then unzip the jacket.

d. If the casualty is able, instruct him to hold his arms up and away from his body, and drape the left and right chest sections of the jacket over the outside of the litter.

e. If the casualty is unable to lift his arms, one augmentee will hold the casualty's gloved hand and perform this action. Another augmentee folds the chest sections over the outside of the litter.

7. Remove the casualty's protective BDO/JSLIST trousers by cutting.

**CAUTION:** Dip and scrub the scissors in the 5% bleach solution before doing each cutting procedure to avoid contaminating the inner garment or the casualty.

a. Cut the suspenders.

b. Cut the leg closure cord at the ankle cuff.

c. Unzip the zipper.

d. Cut from the ankle along the inseam of the left trouser leg until the crotch area is reached, then cut across into the zipper.

e. Cut along the inseam of the right trouser leg until the crotch area is reached, then go sideways into the first cut.

f. Allow trouser halves to drape over the side of the litter.

g. Tuck the remaining cloth between the legs by rolling it, while ensuring that only the black lining is showing.

8. Remove the casualty's butyl rubber gloves (outer glove).

a. Decontaminate your own butyl rubber gloves with M295, M291, or 5% bleach solution.

b. Decontaminate the casualty's gloves with the M295, M291, or 5% bleach solution.

c. Instruct the casualty to hold his arms away from the litter and upper body or, if he cannot comply with instructions, hold his gloves by the fingers.

**CAUTION:** Do not allow the arms to come in contact with the exterior (camouflage) side of the over garment.

d. Grasp the cuff of the glove, turning the glove inside out and remove it.

**NOTE:** Always remove the gloves over the sides of the litter.

e. Carefully lower the patient's arm(s) across his chest as each glove is removed. Avoid touching the patient's cloth glove liner or arm with your rubber glove.

f. Place the gloves in a contaminated disposal container.

g. Decontaminate your own butyl rubber gloves with M295, M291, or 5% bleach solution.

9. Remove the casualty's protective black vinyl overboots (BVO) or multi-purpose overboot (MULO).

a. Unfasten the overboots.

b. Pull the heel downward, and then toward you until the overboot is removed.

c. If the overboot will not come off, cut the boot from top to bottom along the centerline of the boot over along the inside of the boot. Fold the overboot down and gently pull the heel until it is removed.

d. Place the overboots in a contaminated disposal container.

*NOTE:* While you and another team member hold the casualty's raised feet, have a third member wipe down the end of the litter with the 5% solution before lowering the feet to the litter.

10. Remove and secure the casualty's personal effects.

a. Remove the casualty's personal articles from the overgarment and army combat uniform (ACU) pockets.

*NOTE:* Remember to decontaminate your gloves first.

b. Place the articles in "zip lock" plastic bags.

c. Label the bags with the casualty's name and SSN. (Print the information on a piece of paper and place the paper in the plastic bag.)

d. Seal the plastic bags.

e. If the articles are not contaminated, return them to the casualty. If the articles may be contaminated, place the bags in the contaminated holding area until they can be decontaminated. The articles will then be returned to the casualty.

11. Remove the combat boots following the same procedures as for removing the protective overboots.

*NOTE:* Remove the boots without touching the casualty's inner clothing or exposed skin.

**CAUTION:** Decontaminate your butyl rubber gloves in the 5% bleach solution before you touch the casualty's garments or exposed skin.

12. Cut off the casualty's army combat uniform (ACU).

a. Cut off the ACU shirt.

(1) Uncross the casualty's arms.

(2) Cut the ACU shirt using the same procedure as for the protective overgarment jacket.

(3) Recross the casualty's arms over the chest.

b. Unbuckle or cut the belt material.

c. Cut off the ACU trousers following the same procedure as for the protective overgarment trousers.

**CAUTION:** Decontaminate your butyl rubber gloves in 5% bleach solution before you touch the casualty's garments or exposed skin.

13. Remove the casualty's undergarments.

a. Cut off the casualty's under garment.

(1) Cut from the lower side of the hip to the waist on both sides.

(2) Place the under garments into the plastic garbage bag containing the other contaminated items.

(3) Next, gently peel the T-shirt away from the body to avoid spreading contamination if present on undergarment.

## b. Cut off the T-shirt.

(1) Cut up the front of the patient's T-shirt from the waist up to the collar.

(2) Cut both sleeves from the inside, starting at the elbow, up to the shoulder, and then to the collar.

(3) Cut around bandages or splints, leaving them in place.

(4) Next, gently peel the T-shirt away from the body to avoid spreading contamination if present on undergarment.

## c. Cut off the brassiere, if necessary.

(1) Lift the casualty's arm off the chest.

(2) Cut between the cups.

(3) Cut both shoulder straps where they attach to the cup.

(4) Lay the cups away from the casualty onto the litter.

(5) Lay shoulder straps up and over the shoulders onto the litter.

**NOTE:** At this point, the white glove inner liners for a female may be removed while the casualty's arms are lifted off her chest.

## 14. Remove the casualty's glove inner liners.

a. Remove the glove liners using the same procedure as for removing butyl rubber gloves.

b. Cross the casualty's arms over the chest.

## 15. Remove the casualty's socks.

a. Decontaminate your butyl rubber gloves in 5% solution.

b. Position yourself at the foot of the litter.

c. Remove each sock by rolling it down over the foot, turning it inside out or by cutting the sock off.

d. Place the socks into a contaminated disposal container.

## 16. Decontaminate the casualty's ID tags.

a. Decontaminate your butyl rubber gloves in the 5% solution.

b. Wipe the ID tags with the 0.5% solution.

**CAUTION:** Observe proper body mechanics to avoid injury to your back. Use your legs instead of your back to lift the casualty.

## 17. Move the casualty to the skin decontamination area.

a. Decontaminate your butyl rubber aprons and gloves in the 5% solution.

b. Lift the casualty out of the cutaway garments, using a three person arms carry.

(1) Lifter #1 slides his arms (palms turned upward) under the casualty's head/neck and shoulders.

(2) Lifter #2 slides his arms (palms turned upward) under the casualty's back and buttocks.

(3) Lifter #3 slides his arms (palms turned upward) under the casualty's thighs and calves.

(4) On the command of Lifter, bearer #1, lift the casualty. (PREPARE TO LIFT: LIFT.)

c. Once the casualty has been lifted off the litter, all three lifters stand upright and turn the casualty in against their chests.

d. While the casualty is being held, another team member quickly removes the contaminated litter and replaces it with a clean litter. A decontaminatable mesh litter should be positioned, if available.

*NOTE:* At this point, the casualty has nothing on his body except the protective mask and medical items (dressings, splints, tourniquets).

e. Lower the casualty onto the clean litter, in a supine position, on the command of lifter #1.

f. Carry the litter to the skin decontamination area, and then return to the clothing removal area.

g. Dispose of all contaminated material at the clothing removal area.

(1) The casualty's contaminated clothing is placed in a bag and put in a contaminated disposal container.

(2) The dirty litter is rinsed with the 5% decontamination solution and placed in a dirty litter storage area.

**CAUTION:** Before obtaining another casualty, the clothing removal team should rinse their gloves and aprons in the 5% decontaminating solution and drink enough water to compensate for the heat and workload.

18. Perform spot skin decontamination.

*NOTE:* Steps 18 through 23 are performed by personnel in the skin decontamination area. At the skin decontamination area, two to four persons will be working together as a team, one or two on either side of the casualty.

a. Spot decontaminate potential areas of chemical contamination with the M258A1 or M291 Skin Decontaminating Kit or the 0.5% bleach solution.

b. Pay particular attention to areas where gaps exist in the MOPP gear, such as the neck, lower part of the face, waistline, wrists, and ankles.

19. Remove field dressings and bandages.

*NOTE:* This step must be performed by medical personnel.

a. Carefully cut off dressings and bandages.

b. Cut off any remaining clothing that was covered by the dressings and bandages.

c. Decontaminate the exposed areas of skin with the 0.5% solution.

d. Irrigate the wound with the 0.5% solution if the wound is suspected to be contaminated.

*NOTE:* Bandages are not replaced unless there is a critical medical need (for example, to control bleeding). Bandages are replaced when the casualty is in the clean (uncontaminated) treatment area.

e. Place removed dressings and clothing in a contaminated disposal container.

20. Replace any tourniquets.

*NOTE:* Medical personnel must perform this step.



- a. Decontaminate an area above the existing tourniquet.
- b. Place a new tourniquet 1/2 to 1 inch above the old tourniquet.
- c. Remove the old tourniquet.
- d. Remove any remaining clothing or dressings covered by the old tourniquet.
- e. Decontaminate the newly exposed areas.
- f. Place the removed tourniquet, dressings, and clothing in a contaminated disposal container.

21. Decontaminate any splints.

*NOTE:* Splints are only removed by medical personnel.

- a. Stabilize the splinted extremity.
- b. Decontaminate the splint and the extremity by liberally flushing them with the 0.5% solution.

**CAUTION:** Do not remove any part of a traction splint from a femoral fracture.

22. Check the casualty for contamination.

- a. Use M8 chemical agent detector paper or the CAM.
- b. Decontaminate any areas of detected contamination, as necessary.

**CAUTION:** Under no circumstances should a casualty who has not been entirely decontaminated be moved across the hot line. If a wound or splinted area cannot be entirely decontaminated, inform the senior medic. Do not move the casualty across the hot line. He must be treated on the contaminated side of the casualty decontamination station.

23. Transfer the casualty to the shuffle pit.

- a. Personnel decontaminate themselves by rinsing their butyl rubber gloves and apron with the 5% bleach solution.
- b. Carry the casualty to the shuffle pit on the skin decontamination litter.
- c. Place the litter on the litter stand located in the shuffle pit.
- d. Lift the casualty from the decontamination litter using the same technique described in step 17.
- e. Remove the decontamination litter from the stand and a medic from the clean side will replace it with a clean litter.
- f. Lower the casualty onto the clean litter and move back from the hot line.

*NOTE:* Do not step across the hot line. Personnel from the clean side of the hot line will take the casualty to the clean treatment station.

### **Evaluation Preparation:**

Setup: For training and evaluation, use other Soldiers to set up a decontamination site. Use a Soldier that has MOPP gear on as the simulated casualty to be decontaminated. Brief Soldier: Tell the Soldier the simulated casualty requires decontamination.

<b>Performance Measures</b>	GO	NO GO
1 Decontaminated the casualty's hood.	_____	_____
2 Cut off the casualty's hood.	_____	_____
3 Decontaminated the casualty's mask and exposed skin.	_____	_____
4 Removed the casualty's FMC.	_____	_____
5 Removed gross contamination.	_____	_____
6 Removed the casualty's protective overgarment jacket.	_____	_____
7 Removed the casualty's protective overgarment trousers.	_____	_____
8 Removed the casualty's butyl rubber gloves.	_____	_____
9 Removed the casualty's protective overboots.	_____	_____
10 Removed and secured the casualty's personal effects.	_____	_____
11 Removed the casualty's combat boots.	_____	_____
12 Removed the casualty's ACU.	_____	_____
13 Removed the casualty's undergarments.	_____	_____
14 Removed the casualty's glove inner liners.	_____	_____
15 Removed the casualty's socks.	_____	_____
16 Decontaminated the casualty's ID tags.	_____	_____
17 Moved the casualty to the skin decontamination area.	_____	_____
18 Performed spot skin decontamination.	_____	_____
19 Removed field dressings and bandages.	_____	_____
20 Replaced any tourniquets.	_____	_____
21 Decontaminated any splints.	_____	_____
22 Checked the casualty for contamination.	_____	_____
23 Transferred the casualty to the shuffle pit.	_____	_____

**Evaluation Guidance:** Score each Soldier according to the performance measures. Unless otherwise stated in the task summary, the Soldier must pass all performance measures to be scored GO. If the Soldier fails any steps, show what was done wrong and how to do it correctly.

**References**

**Required**  
DD Form 1380

**Related**  
STP 21-1-SMCT

## Set Up a Casualty Decontamination Station

**081-833-0093**

**Conditions:** You are assigned to a division level medical facility battalion aid station (BAS) or division clearing station (DCS). Chemical agents are being used against the units supported by your medical treatment facility. The commander has ordered that a decontamination station and protective shelter be established. Your current location is in a non-contaminated area, upwind from the chemical hazard. You are in a CBRN environment.

**Standards:** Set up a fully operational patient decontamination station (PDS) in a non-contaminated area upwind from the chemical hazard. Establish the decontamination area on the downwind side of the protective shelter or other clean treatment area and clearly mark a hot line. Construct a shuffle pit as the only point of access to the clean areas. Install chemical agent alarms.

### Performance Steps

1. Select sites for the location of the operation.

a. Relate and alternate sites must be selected in advance of operations.

*NOTE:* Alternate sites must be selected in conjunction with selection of the primary site. If the prevailing winds change direction by more than 30 degrees, use of the primary site may no longer be possible. A wait of 10 to 15 minutes to determine if the change is permanent should precede the move. When the station is moved, it must be moved at least 75 meters upwind from any contaminated area.

b. Site selection factors.

- (1) The direction of the prevailing winds.
- (2) The downwind chemical hazard.
- (3) The availability of protective shelters or buildings to house clean treatment facilities.
- (4) The terrain.
- (5) Availability of cover and concealment.

*NOTE:* The protective shelter may possess visual, audible, and infrared signatures. Therefore, concealment may be compromised.

- (6) The general tactical situation.
- (7) The availability of evacuation routes (contaminated and clean).

(8) The location of the supported unit's vehicle decontamination point, personnel decontamination point, and MOPP exchange point.

*NOTE:* It is sometimes best to co-locate with these unit decontamination sites. The arrangement of the operational areas must be kept flexible and adaptable to both the medical and tactical situations.

2. Set up the decontamination area. (See Figure 3-6.)

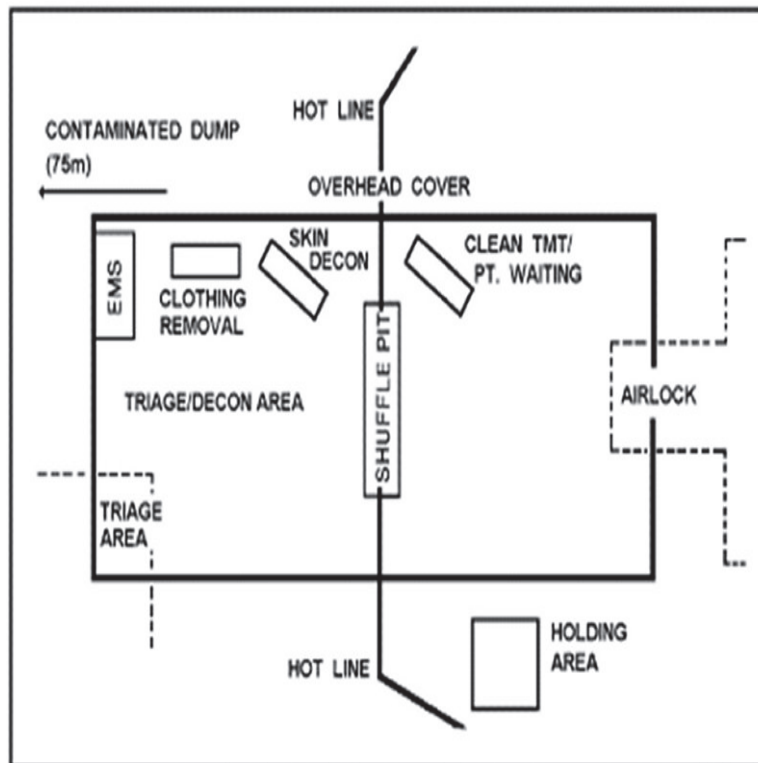

Figure 3-6. Decontamination area

- a. Triage area.
  - b. Emergency treatment area.
- NOTE:* Sometimes, triage and emergency treatment are conducted in the same area.
- c. Clothing removal area.
  - d. Skin decontamination area.
  - e. Overhead cover.

(1) Erect an overhead cover, at least 20 x 50 feet, to cover the decontamination area and the clean waiting and treatment area. If the protective shelter is used, the overhead cover should overlap the air lock entrance.

(2) If plastic sheeting is not available, alternate materials such as trailer covers, ponchos, or tarpaulins may be used.

3. Set up the clean side of the decontamination station on the upwind side of the contaminated areas.

*NOTE:* Erect a windsock for easy determination of wind direction.

- a. Clean waiting area.
- b. Clean treatment area.

4. Set up the shuffle pit as the only point of access between the decontamination area and the clean waiting and treatment area.

a. Turn over the soil in an area that is 1 to 2 inches deep, and of sufficient length and width to accommodate a litter stand.

*NOTE:* The shuffle pit should be wide enough that the litter bearers are not able to straddle the pit or accommodating an ambulatory patient and two assistants.

b. Mix super tropical bleach (STB) with the soil in a ratio of two parts STB to three parts earth (by volume).

5. Set up the protective shelter on the upwind side of the clean waiting and treatment area.

a. Set up the protective shelter with the air lock adjoining the clean side of the decontamination station.

b. When a protective shelter is not available for use, set up a protected medical treatment facility 30 to 50 meters upwind from the shuffle pit.

6. Set up the evacuation holding area.

a. Set up an overhead cover of plastic sheeting at least 20 x 25 feet.

b. Make sure the cover overlaps part of the clean treatment area and part of the protective shelter.

c. When the protective shelter is used, set up the cover on the side opposite the generator.

7. Mark the hot line. The hot line separates the PDS warm zone (dirty side) from the cold zone (clean side) where the MTF is located.

a. Use wire, engineer's tape, or other similar material to mark the entire perimeter of the hot line.

b. Ensure that the hot line is clearly marked.

8. Establish ambulance points on both the "clean" and "dirty" evacuation routes.

a. Establish a "dirty" ambulance point downwind from the triage area in the decontamination station.

b. Establish a "clean" ambulance point upwind from the evacuation holding area on the clean side of the decontamination station.

9. Set up a contaminated dump.

a. Establish the contaminated waste dump at least 75 to 100 meters downwind from the hot line.

b. Bags of contaminated clothing and bandages are taken to this area where they are buried and marked with the appropriate hazard markers (the North Atlantic Treaty Organization "gas" markings).

*NOTE:* The position is communicated to headquarters so that the waste can be disposed of properly.

10. Place chemical agent alarms upwind from the clean treatment area.

11. Camouflage areas IAW tactical directives.

### **Evaluation Preparation:**

Setup: For training and evaluation, use other Soldiers as your labor source.

Brief Soldier: Tell the Soldier a decontamination station needs to be established.

<b>Performance Measures</b>	GO	NO GO
1 Selected sites for the location of the operation.	_____	_____
2 Set up the decontamination area.	_____	_____
3 Set up the clean side of decontamination station upwind of the contaminated areas.	_____	_____
4 Set up the shuffle pit.	_____	_____
5 Set up the protective shelter.	_____	_____
6 Set up the evacuation holding area.	_____	_____
7 Marked the hot line.	_____	_____
8 Established ambulance points.	_____	_____
9 Set up a contaminated dump.	_____	_____
10 Placed chemical agent alarms.	_____	_____
11 Camouflaged areas.	_____	_____

**Evaluation Guidance:** Score each Soldier according the performance measures. Unless otherwise stated in the task summary, the Soldier must pass all performance measures to be scored GO. If the Soldier fails any steps, show what was done wrong and how to do it correctly.

**References**

**Required**  
None

**Related**  
None

## Subject Area 9: Triage and Evacuation

### Initiate a 9-Line Medevac Request

**081-833-0283**

**Conditions:** You have a casualty requiring medical evacuation (MEDEVAC) and you will need a patient pickup site. You will need operational communications equipment, MEDEVAC request format, and unit signal operation instructions (SOI).

**Standards:** Transmit a MEDEVAC request, providing all necessary information as quickly as possible. Transmit, as a minimum, line numbers 1 through 5 during the initial contact with the evacuation unit. Transmit lines 6 through 9 while the aircraft or vehicle is en route, if not included during the initial contact.

#### **Performance Steps**

1. Collect all applicable information needed for the MEDEVAC request.
  - a. Determine the grid coordinates for the pickup site. (See task 071-329-1002.)
  - b. Obtain radio frequency, call sign, and suffix.
  - c. Obtain the number of patients and precedence.
  - d. Determine the type of special equipment required.
  - e. Determine the number and type (litter or ambulatory) of patients.
  - f. Determine the security of the pickup site.
  - g. Determine how the pickup site will be marked.
  - h. Determine patient nationality and status.
  - i. Obtain pickup site chemical, biological, radiological, and nuclear (CBRN) contamination information normally obtained from the senior person or medic.

*NOTE:* CBRN line 9 information is only included when contamination exists.

2. Record the gathered MEDEVAC information using the authorized brevity codes.

*NOTE:* Unless the MEDEVAC information is transmitted over secure communication systems, it must be encrypted, except as noted in step 3b(1).

- a. Location of the pickup site (line 1).
- b. Radio frequency, call sign, and suffix (line 2).
- c. Numbers of patients by precedence (line 3).
- d. Special equipment required (line 4).
- e. Number of patients by type (line 5).
- f. Security of the pickup site (line 6).
- g. Method of marking the pickup site (line 7).
- h. Patient nationality and status (line 8).
- i. CBRN contamination (line 9).

3. Transmit the MEDEVAC request. (See task 113-571-1022.)

*NOTE:* Transmission may vary depending on individual experience level and situation.

- a. Contact the unit that controls the evacuation assets.

- (1) Make proper contact with the intended receiver.
- (2) Use effective call sign and frequency assignments from the SOI.
- (3) Give the following in the clear "I HAVE A MEDEVAC REQUEST;" wait one to three seconds for a response. If no response, repeat the statement.

b. Transmit the MEDEVAC information in the proper sequence.

(1) State all line item numbers in clear text. The call sign and suffix (if needed) in line 2 may be transmitted in the clear.

*NOTE:* Line numbers 1 through 5 must always be transmitted during the initial contact with the evacuation unit. Lines 6 through 9 may be transmitted while the aircraft or vehicle is en route.

(2) Follow the procedure provided in the explanation column of the MEDEVAC request format to transmit other required information.

(3) Pronounce letters and numbers according to appropriate radiotelephone procedures.

(4) End the transmission by stating "OVER."

(5) Keep the radio on and listen for additional instructions or contact from the evacuation unit.

**Evaluation Preparation:**

Setup: Evaluate this task during a training exercise involving a MEDEVAC aircraft or vehicle, or simulate it by creating a scenario and providing the information as the Soldier requests it. You or an assistant will act as the radio contact at the evacuation unit during "transmission" of the request. Give a copy of the MEDEVAC request format to the Soldier.

Brief Soldier: Tell the Soldier to prepare and transmit a MEDEVAC request. State that the communication net is secure.

<b>Performance Measures</b>	GO	NO GO
1 Collected all applicable information needed for the MEDEVAC request line items 1 through 9.	_____	_____
2 Recorded the information using the authorized brevity codes.	_____	_____
3 Transmitted the MEDEVAC request.	_____	_____

**Evaluation Guidance:** Score each Soldier according to the performance measures in the evaluation guide. Unless otherwise stated in the task summary, the Soldier must pass all performance measures to be scored GO. If the Soldier fails any step, show what was done wrong and how to do it correctly

**References**

**Required**  
None

**Related**  
FM 4-02.2  
FM 8-10-6  
STP 21-1-SMCT



## Load Casualties onto a UH-60 Series Helicopter

**081-833-0214**

**Conditions:** You have completed treating and triaging multiple casualties. You are in charge of loading litter and ambulatory patients on a standard UH-60 helicopter. You are not in a CBRN environment.

**Standards:** Configure the aircraft properly and load and unload casualties in the correct sequence for the transport platform.

### Performance Steps

1. Follow principles of loading casualties aboard a rotary-wing aircraft.

*NOTE:* The UH-60A Blackhawk, as with the UH-1H/V, has a number of possible seating or cargo configurations. A major difference in preparing the UH-60A to carry litters is that a medical evacuation kit must be installed. This kit consists of a seat/converter assembly unit and a litter support unit. The seat/converter assembly unit provides for three rear-facing seats which allow the medical attendant and crew chief to monitor casualties. The litter support unit consists of a center pedestal which can be rotated 90 degrees about the vertical axis for the loading and unloading of casualties.

- a. Responsibility for loading and securing a rotary-wing aircraft.

- (1) The pilot has the overall responsibility for the proper loading and securing of litter and ambulatory casualties and related equipment on board the aircraft.

- (2) The flight medic crewmember is responsible for ensuring that the litter squad follows the prescribed methods for loading litter or ambulatory casualties and securing litters and related medical equipment.

- (3) The final decision regarding how many casualties may be safely loaded rests with the pilot.

- b. Safety measures.

- (1) Litter bearers must present as low a silhouette as possible and must keep clear of the main and tail rotors at all times.

- (2) The helicopter must not be approached until a crewmember signals to do so.

- (3) The litter bearers should approach the aircraft at a 45-degree angle from the front of the helicopter.

- (4) If the helicopter is on a slope and conditions permit, loading personnel should approach the aircraft from the downhill side.

- (5) Directions given by the crew must be followed, and litters must be carried parallel to the ground.

- (6) Smoking is not permitted within 50 feet of the aircraft.

2. Determine UH-60 rotary wing aircraft load capacities.

- a. Four to six casualty litter capability of the support unit.

- b. If litter casualties are not being evacuated, a maximum of six ambulatory casualties can be seated on the litter support unit (three on each side). A seventh casualty can be seated on a troop seat.

3. Determine the loading sequence.

a. The most seriously injured casualties are loaded last on the bottom pans of the litter support unit. However, if it is anticipated that a casualty's medical condition may require in-flight emergency medical care (such as cardiopulmonary resuscitation), should be loaded onto either of the top pans to facilitate access.

b. Casualties in traction splits should be loaded last and on a bottom pan.

c. The UH-60A has the capability to be loaded on both sides simultaneously. Casualties should be loaded so that upon rotating the litter support, the casualty's head will be forward in the cabin. To accomplish this, casualties loaded on the left side of the aircraft should be loaded head first and casualties loaded on the right side of the aircraft should be loaded feet first (left and right sides are determined from the position of the pilot in command's seat, looking forward).

d. When the six-litter configuration is used, the fifth and sixth litter casualties are loaded with the carousel in the fly position. The head of each casualty should face toward the front of the aircraft.

#### 4. Direct nonmedical Soldiers to load and secure casualties.

a. In loading four litter casualties with a four-man litter squad, the litters are loaded from the top to bottom. The sequence for loading litters from one side of the aircraft with the carousel turned is upper right, upper left, lower right, and then lower left. To load litters from both sides of the aircraft simultaneously, the sequence is upper then lower.

(1) The litter support unit is rotated 90 degrees clockwise to receive the litter casualties. The flight crew lowers the top pan to accept the litter and stands by to assist. This is accomplished as the litter squad approaches the aircraft.

(2) The litter squad moves into the semi overhead carry, lifting the litter just high enough for the litter stirrups of one end to slide onto the litter pan. The litter squad slides the litter forward. The flight crew member guides and assists the litter squad, until the litter stirrups of both ends are secured on the pan. The litter squad departs as the flight crew member raises the pan back to its upright position and secures it. The flight crew member fastens the litter straps attached to the litter support assembly.

(3) After the first litter is loaded, the squad leaves the aircraft as a team to obtain another litter casualty. The second, third, and fourth litters are loaded in the same manner, except that the bottom pans are not tilted to receive casualties.

(4) After having loaded four litter casualties, the litter support unit is rotated 90 degrees counterclockwise and locked in the in-flight position. The cargo doors must be closed for flight.

b. The loading of six litter casualties requires the repositioning of the litter support prior to loading. The loading procedure remains the same as the four-litter configuration except for the following:

(1) The top litter support no longer tilts. This necessitates overhead loading and may require additional assistance.

(2) After four litters are loaded, the pedestal must be rotated back to the locked position. The restraint and tube assembly modification kit is then installed. The last two litters are side loaded between the restraints, with the casualties' heads toward the front of the aircraft. They are secured.

c. When the aircraft is to receive a mixed load of litter and ambulatory casualties, one top pan of the litter support is removed and repositioned just above the bottom pan on the same side. The aircraft can now accommodate two or three litter and four ambulatory casualties.

(1) The litter support unit is rotated clockwise to receive the litter casualties, except for the third litter in the six-litter configuration. Upon loading and securing the litter casualties, the litter support unit is rotated counterclockwise to the in-flight position. The third litter is then loaded when the six-litter configuration is used.

(2) Ambulatory casualties are escorted to the aircraft by ground personnel. They are assisted into their seats and secured with the seat belts attached to the litter support unit.

**WARNING:** To prevent further injury to casualties, all end support pins of the installed litter pans must be in the locked position for flight.

(3) The cargo doors are now closed for flight.

**Evaluation Preparation:**

Setup: For training and evaluation, use other Soldiers as litter bearers and casualties.

Brief Soldier: Tell the Soldier that the simulated Soldiers require loading onto the helicopter. The graded Soldier will be the primary litter bearer and decide loading priorities.

**Performance Measures**

	GO	NO GO
1 Followed the principles of loading casualties on a rotary-wing aircraft.	_____	_____
2 Determined UH-60 rotary wing aircraft capacities.	_____	_____
3 Determined the loading sequence.	_____	_____
4 Directed nonmedical Soldiers to load and secure casualties.	_____	_____

**Evaluation Guidance:** Score each Soldier according to the performance measures. Unless otherwise stated in the task summary, the Soldier must pass all performance measures to be scored GO. If the Soldier fails any steps, show what was done wrong and how to do it correctly.

**References**

**Required**  
None

**Related**  
None

## Perform Manual Evacuation

081-833-0282

**Conditions:** You are in a care under fire situation. You have a team member that has been wounded by sniper fire. The casualty is unable to return fire, move to cover nor provide self aid. You and the rest of your team are behind cover and returning fire. Enemy fire has been suppressed and you must rapidly move to your casualty and manually evacuate him from the point of injury (POI) to cover. You will need a Combat Rescue Sling (CRS), Dragon Handle System, Dragon Harness and a Rescue Assault Tether (RAT) Strap System. If none of these are present, you will utilize one of the manual carries listed below. You are not in a CBRN environment.

**Standards:** Perform manual evacuation of your casualty, by extracting your casualty to cover with the use of the Combat Rescue Sling, Dragon Handle System, Dragon Harness System, RAT Strap System or manual carries without causing further injury.

### Performance Steps

1. Determine the appropriate extraction device, or carry for the tactical situation.
2. Communicate the plan to the casualty.
3. Tactically approach the casualty.
4. Secure the casualty's weapon and other equipment as feasible.
5. Properly attach the appropriate extraction device or secure the casualty for manual carry.
  - a. Combat Rescue Sling (single rescuer).

**NOTE:** The Combat Rescue Sling (CRS) is a five link, tubular nylon, extraction device that enables rescuers to either drag or carry a casualty. The CRS has five color coded tubular nylon loops (one green, two brown and two black) and is rated at 4,500 lbs.

(1) Spread the CRS over the casualty's body with the green loop on the casualty's neck and the two brown loops at the casualty's arms.

(2) Place each arm through each of the two brown loops (one arm per loop).

**CAUTION:** Do not place the casualty's head through the green loop.

(3) Take the entire green loop, which is on the casualty's neck, and rotate it behind the casualty's head.

(4) Position yourself at the casualty's head and grab both black loops, as handles.

(5) Drag the casualty to cover.

b. CRS (four man rescue).

(1) Spread the CRS over the casualty's body with the green loop on the casualty's neck and the two brown loops at the casualty's arms.

(2) Slide one of the casualty's legs through one of the black loops and the other leg through the other black loop.

(3) Place each arm through each of the two brown loops (one arm per loop).

**CAUTION:** Do not place the casualty's head through the green loop.

(4) Take the entire green loop, that is on the casualty's neck and rotate it behind the casualty's head.

(5) Have all four rescuers position themselves two on each side of the casualty, facing the same direction.

(6) The rescuers at the casualty's shoulders grab the brown loops and the rescuers at the casualty's thighs grab the black loops.

(7) All four rescuers lift the casualty off of the ground simultaneously and move out to cover.

c. Dragon Handle System (head first extraction).

*NOTE:* The Dragon Handle System is a rapid extraction device that has two handles, a metal floating bull ring (which provides for adjustable attachment points) and a spring actuated non-locking carabiner. The Dragon Handle System has a tensile strength of 4,200 lbs and is made of 1 inch tech tape.

(1) Kneel down next to the closest shoulder of the casualty.

**WARNING:** Do not pass the carabiner under the strap that attaches the DAP (Deltoid Armor Protection) to the shoulder strap of the body armor.

(2) Pass the carabiner (that is attached to the distal portion of the Dragon Handle System) under the shoulder strap of the casualty's body armor.

(3) Pass the Dragon Handle straps through the keeper of the carabiner and pull up (taking out the slack).

*NOTE:* If the rescuer is short, hook the carabiner through the two loops located approximately 1/3 down from the handles.

(4) Grab both Dragon Handles with the non firing hand and stand up.

(5) Stand up and lean slightly back (which will slightly elevate the casualty's torso off the ground).

(6) Drag the casualty to cover.

d. Dragon Handle System (feet first extraction).

(1) Kneel down next to the casualty's feet.

(2) Pass the carabiner (that is attached to the distal portion of the Dragon Handles) under and around the casualty's ankles.

(3) Pass the Dragon Handle straps through the keeper of the carabiner and pull up (taking out the slack).

(4) Grab both Dragon Handles with the non firing hand and stand up.

(5) Stand up and lean slightly back (which will slightly elevate the casualty's legs off the ground).

*NOTE:* This will lift both of the casualty's legs and reduce the friction that the casualty's body would create.

(6) Drag the casualty to cover.

e. Dragon Harness System.

*NOTE:* The Dragon Harness System is a lightweight, built-in-handle harness system that is constructed of two inch nylon webbing and is rated at over 3,000lbs tensile strength. The

harness is worn like a vest under the body armor of the casualty. The drag handles are stowed slightly above the rear collar of the body armor and are held in place by a Velcro strap. The benefit of the Dragon Harness is that when the casualty is being extracted, the casualty's body armor doesn't move up toward the casualty's head exposing more of the casualty's torso to possible enemy fire.

(1) Kneel down next to the casualty's shoulders.

(2) Grab both Dragon Handles with the non firing hand and stand up.

(3) Stand up and lean slightly back (which will slightly elevate the casualty's torso off the ground).

(4) Drag the casualty to cover.

f. RAT Strap (feet first rescue).

**NOTE:** The RAT Strap is a 1 inch tech tape patient extraction system that has a quick release shackle on one end and a National Fire Protection Association NFPA rated carabiner on the opposite end. The RAT Strap is rated at 4,200lbs tensile strength. Along over two thirds of the length of the strap (from the quick release shackle to approximately two thirds of the strap) there is reinforced stitching, triple bar tacked loops which enables the rescuer to shorten the length of the strap to elevate the casualty's body off the ground and reduce friction during the extraction.

In order to use the RAT Strap, a special belt with a carabiner attachment ring must be worn or a regular military belt must be fitted with a carabiner. The RAT Strap should be attached to the carabiner attachment ring, or the carabiner (attached already to the rescuer's belt) by way of the Quick Release Shackle, and tucked into the rescuer's trouser pocket that is located on the rescuer's non firing hand side, prior to tactically approaching the casualty.

Estimate the amount of slack that would be needed to be taken out of the overall length of the RAT Strap to ensure that the casualty's upper torso will lift off of the ground. Hook the carabiner through the triple bar tack loop that will give you the proper length of the RAT Strap.

(1) Kneel down next to the casualty's feet.

(2) Pass the carabiner (that is attached to the distal portion of the RAT Strap) under and around the casualty's ankles.

(3) Loop the RAT Strap through the keeper of the carabiner and pull up (taking out the slack).

(4) Stand up and lean slightly back (which will slightly elevate the casualty's legs off the ground).

(5) Drag the casualty to cover.

g. RAT Strap (head first rescue).

**WARNING:** Do not pass the carabiner under the strap that attaches the DAP to the shoulder strap of the body armor.

(1) Pass the carabiner (that is attached to the distal portion of the RAT Strap) under the shoulder strap of the casualty's body armor.

(2) Pass the RAT Strap through the keeper of the carabiner and pull up (taking out the slack).

(3) Stand up and lean slightly back (which will slightly elevate the casualty's legs off the ground).

(4) Drag the casualty to cover.

h. Hawes Carry.

*NOTE:* The Hawes Carry can only be performed on a conscious casualty that can hold onto the rescuers body.

(1) Assist the casualty in standing.

(2) Squat in front of the casualty, while maintaining an erect posture.

(3) Have the casualty lean forward, against the rescuer’s back, and wrap an arm around the rescuer’s neck and across the rescuers chest.

*NOTE:* The casualty wraps the same arm as the rescuer’s shooting hand around the rescuer’s neck. This enables the rescuer to secure the casualty’s arm with his non-firing hand.

(4) The rescuer then leans slightly forward and then stands up (lifting with the large muscles of the legs).

(5) The rescuer then moves out to cover with the casualty.

i. SEAL Team Three Carry.

(1) Have a rescuer kneel on both sides of the casualty.

(2) Place the casualty in the sitting position.

(3) Place the casualty’s arms around each of the two rescuer’s neck.

(4) Have the rescuers grab the casualty’s wrist with the hands located on the outside of the rescuers’ body.

(5) Have the rescuers grab the casualty’s belt with the hands located on the inside towards the casualty.

(6) Both rescuers simultaneously stand (lifting with the large muscles of the legs).

(7) The rescuers then move out to cover with the casualty.

6. Extract the casualty to cover.

**Evaluation Preparation:**

Setup: At the test site, provide all equipment, information, and personnel given in the task conditions statement.

Brief Soldier: Tell the Soldier that he must manually extract a casualty in a care under fire situation and to utilize one of the devices mentioned in the task. The Soldier may utilize other Soldiers as assistants as necessary.

<b>Performance Measures</b>	GO	NO GO
1 Determined the appropriate extraction device, or carry, for the tactical situation.	_____	_____
2 Communicated the plan to the casualty.	_____	_____
3 Tactically approached the casualty.	_____	_____
4 Secured the casualty’s weapon and other equipment as feasible.	_____	_____
5 Properly attached the extraction device or secured the casualty for manual carry.	_____	_____

**Performance Measures**

GO

NO GO

6 Extracted the casualty to cover.

\_\_\_\_\_

\_\_\_\_\_

**Evaluation Guidance:** Score each Soldier according to the performance measures. Unless otherwise stated in the task summary, the Soldier must pass all performance measures to be scored GO. If the Soldier fails any steps, show what was done wrong and how to do it correctly.

**References**

**Required**  
None

**Related**  
None



## **Establish a Casualty Collection Point**

**081-833-0152**

**Conditions:** You have a tactical battle plan for medical evacuation. You will need FM 4-02.4 and FM 4-02.6. You are not in a CBRN environment.

**Standards:** Establish a casualty collection point (CCP).

### **Performance Steps**

1. Select the site.

*NOTE:* Tactical battle plans will vary depending on the type and number of units incorporated into the plan. The plan for casualty collection points (CCP) will vary also. The medical treatment provided on the battlefield is usually accomplished by the unit's combat medics and combat lifesavers. Establishment of a CCP is essential for the rapid treatment and evacuation of the casualty.

- a. The location of the CCP will depend on the unit location, the tactical situation, and the number of casualties to be evacuated.

- b. This location should be decided by the unit first sergeant with guidance from the company/platoon medics.

- c. Battle drills and tactical standard operating procedures (TSOPs) should be established on how they will get the casualty from the fighting position or vehicle to the CCP.

- d. The platoon CCP should be located at the platoon's rear.

- e. The company CCP should be located in a covered and concealed position with the company trains.

2. Establish the CCP with day and night marking systems.

3. Establish a separate triage area with day and night marking systems.

4. Establish a choke point for entry and exit of the CCP to track casualties and control access.

*NOTE:* The choke point is also where casualties are triaged.

5. Establish and properly mark evacuation categories for day and night (non-tactical or tactical) operations.

*NOTE:* When marking the evacuation category areas for day and night operations, one should utilize the marking procedures outlined in the unit's TSOP. An example of marking evacuation category areas for day time operations is utilizing red for Immediate /(Urgent/Urgent Surgical), green for Delayed /Priority, blue for Expectant /Routine and None for Minimal /Convenience. For night non-tactical CCP operations, the same color code used during daytime CCP operations can be used with colored chemlights. For night tactical CCP operations, an example of marking would be 1 Infrared ( IR) chemlight for Immediate /(Urgent/Urgent Surgical), 2 IR chemlights for Delayed / Priority, 3 IR chemlights for Expectant /Routine and 4 chemlights for Minimal /Convenience.

6. Establish a killed in action (KIA) area away from the other casualties.

7. Establish a medical resupply area.

8. Establish a helicopter landing zone.

*NOTE:* A helicopter landing zone should be properly marked for air evacuation.

9. Plan movement of casualties.

a. Casualty movement from point of wounding to the platoon CCP will be by field expedient means: individual manual carries, litter (SKED, talon, pole less) carries, or casualty evacuation vehicle.

b. Nonstandard casualty evacuation vehicles are positioned forward with a M113A3, Stryker, M996, or M997 track or wheeled ambulance designated for litter casualties at the company CCP.

c. The first sergeant coordinates casualty flow between the platoon CCPs and the company CCP while the senior medic conducts triage.

d. Communication of 9 line medical evacuation requests is conducted via the platoon or company elements to the battalion aid station (BAS.)

e. The procedure/drill from the CCP to the BAS focuses largely on distance, routes, security, and operational procedures at the BAS.

*NOTE:* "Operational procedures" refers to the set up and functionality of the BAS with regards to casualty flow, triage, treatment, and various other functions required for successful operation. In some cases the BAS will split into two treatment teams: the main aid station (MAS) and a forward aid station (FAS). Often the MAS and the FAS will conduct bounding movement during an offensive operation to maintain doctrinal distance during the fight. Whether evacuation is from the CCP to the MAS, FAS, or BAS the system remains essentially the same.

*NOTE:* Doctrinal distance is considered to be 1 to 4 kilometers and/or one to two terrain features behind the unit supported, emphasizing mission, enemy, terrain, troops, time available, and civilian considerations (METT-TC). Failure to maintain this is a common error. Usually the distance becomes extended due to poor planning, failure to commit medical assets forward, lack of clearly defined triggers, or communications failures.

**Evaluation Preparation:**

Setup: At the test site, provide all equipment, information, and personnel given in the task conditions statement.

Brief Soldier: Tell the Soldier that he must establish a casualty collection point (CCP) and may have to request medical evacuation and establish a helicopter landing point after establishing the CCP.

<b>Performance Measures</b>	GO	NO GO
1 Selected the site.	_____	_____
2 Established the CCP with day and night marking systems.	_____	_____
3 Established a separate triage area with day and night marking systems.	_____	_____
4 Established a choke point for entry and exit of the CCP to track casualties and control access.	_____	_____
5 Established and properly marked evacuation categories for day and night (non-tactical or tactical) operations.	_____	_____
6 Established KIA area away from other casualties.	_____	_____
7 Established medical resupply area.	_____	_____
8 Established a helicopter landing zone.	_____	_____
9 Planned movement of casualties.	_____	_____

**Evaluation Guidance:** Score each Soldier according to the performance measures. Unless otherwise stated in the task summary, the Soldier must pass all performance measures to be scored GO. If the Soldier fails any steps, show what was done wrong and how to do it correctly.

**References**

**Required**  
FM 4-02.4  
FM 4-02.6

**Related**  
None

**Load Casualties Onto A Mine Resistant Heavily Armored Ground Ambulance (HAGA) 6X6  
RG. 33L**

**081-833-0284**

**WARNING:** Moving or sliding interior components can pinch or crush fingers or hands. Ensure fingers or hands are clear of pinch points before adjusting equipment. Use provided handles to prevent injury. Failure to comply may result in injury to personnel.

**Conditions:** You have completed treating and triaging multiple casualties. You are in charge of loading litter and ambulatory casualties onto a Mine Resistant Heavily Armored Ground Ambulance (HAGA). You will need a HAGA armored ambulance and litters. You are not in a CBRN environment.

**Standards:** Load casualties in the correct sequence for the evacuation platform without causing further harm to the casualties.

**NOTE:** The litter system stowed configuration is used for the transport of medical supplies and the medical decontamination of the ambulance.

**Performance Steps**

1. Configure stairs to ramp.

**WARNING:** Ensure hands and feet are clear of the ramp. The upper section of the ramp will drop when the ramp is unfolded resulting in crushed or pinched body parts. Failure to comply may result in injury to personnel.

- a. Ensure that the ramp door is closed.
  - b. While supporting the ramp assembly, lift and release the secure clamps from the latches, allowing the ramp to be unfolded.
  - c. Unfold and straighten the lower ramp section from the middle ramp section.
  - d. Lift the middle and lower ramp section until they are parallel to the ground.
  - e. Disengage the retaining pin from the lower ramp section.
  - f. Rotate the ramp steps where the steps face the ground.
  - g. Re-engage the retaining pin in the lower ramp step until the step locks into position.
  - h. Lower the ramp until the bottom reversed step contacts the ground.
  - i. Lift the ramp and straighten the combined middle and lower section to the upper ramp section.
  - j. Make sure the locks are completely engaged with the pins on the middle ramp section.
  - k. Lower the entire ramp to make contact with the ground.
  - l. Open the rear door and lock into place.
2. Configure the left side of the casualty compartment for litter casualties.
    - a. The first step in transitioning the litter system from the stowed configuration to any other patient load configuration is to rotate the left footrest into its functional position.
      - (1) Twist to unlock and pull to disengage the front and rear capture pins, on the left litter system seat, and rotate the foot rest out.

(2) Push in and twist the two capture pins, on the left litter system seat, locking the footrest in the functional position.

**WARNING:** Failure of seated personnel to use designated footrests may result in injury.

Maintain positive physical control of vertical and horizontal portions of the litter system at all times while the capture pins are in the unlocked and out position.

b. Twist to unlock and pull to disengage the front and rear capture pins for the left litter system seat and rotate the left seat bottom to the down position.

c. Push to engage and twist to lock the forward and rear capture pins to lock the left seat back in the vertical position.

d. Remove and store the left seat back cushion.

e. Twist to unlock and pull to disengage the front and rear capture pins to unlock the left seat back, and rotate the left seat back into the lower left litter position.

f. Push to engage and twist to lock the forward and rear capture pins of the left lower litter system.

**CAUTION:** The litter system attached to the litter lift should be in the unstowed (horizontal) position prior to raising the lift. Failure to unstow the litter system could result in system damage.

g. Twist to unlock and pull to disengage the forward and rear capture pins of the upper left litter systems.

h. Rotate the upper left litter system to the horizontal position.

i. Push in to engage and twist to lock the forward and rear capture pins of the upper left litter system.

j. Slide out the upper left litter system.

(1) Pull the center pull handle to retract the slide lock pins. This will release the litter system slide and allow it to move.

(2) Pull the litter system slide out (towards the center of the patient compartment) until it stops.

(3) Release the center pull handle to engage the slide lock pins and lock the litter slide in place.

3. Load the litter casualties on the left upper and left lower litter systems.

**CAUTION:** The stairs should be reconfigured to the ramp configuration to ensure safe loading of casualties into the evacuation platform.

a. Load the casualty into the evacuation platform head first.

(1) Lift the litter with one person holding both litter handles at the casualty's head and one person at the casualty's feet. Place two litter bearers along the side of the litter to support the litter while the litter bearers walk up the litter ramp.

(2) Once the litter bearer at the casualty's head comes into close proximity to the doorway of the patient compartment, the litter bearers who are standing on the side of the litter will support the litter.

(3) The litter bearer at the casualty's head will ensure that all three litter bearers are supporting the litter and then release his grasp on the litter handles.

(4) The litter bearer will turn around and face the casualty.

(5) Once the litter bearer, at the casualty's head, has turned around, he will grab the litter handles.

(6) Once in position, the litter team will slowly continue to walk the litter up the litter ramp and into the evacuation platform.

**CAUTION:** With the upper left litter system in the out position, the loading of the litter into the litter system tracks should be performed with caution due to the limited space in the compartment and the angles the litter bearer, at the casualty's head, must turn his body to load the litter stirrups into the litter system tracks.

b. Place the litter stirrups, located at the casualty's head, in the litter system tracks.

c. Slide the litter along the tracks until the litter weight is fully supported and the forward stirrups contact the front stop.

d. Engage the front and rear litter lock mechanisms, visually confirming that the litter lock mechanisms pass through all four stirrups.

e. Pull the center pull handle to retract the slide lock pins. This will release the litter slide system and allow it to move.

f. Push the litter system slide in towards the wall and release the center pull handle to engage the slide lock pins and lock the litter slide in place.

**CAUTION:** The litter system attached to the litter lift should be in the unstowed (horizontal) position prior to raising the lift. Failure to unstow the litter system could result in system damage.

g. Turn the master power switch (located up in the driver's compartment) to the on position.

h. Locate the push button assembly which is located on either left front or right rear of the patient compartment.

i. In case of a power failure (manual lift):

(1) Press and hold the litter lift up button on the push button assembly.

(2) Release the motor brake by turning the brake switch on the drive motor counterclockwise.

(3) Attach a 1/2 inch square drive socket wrench to the left front of the litter lift manual drive and rotate the driveshaft clockwise to raise the litter lift.

j. Raise the litter.

k. Slide out the lower left litter system.

(1) Pull the center pull handle to retract the slide lock pins. This will release the litter system slide and allow it to move.

(2) Pull the litter system slide out (towards the center of the patient compartment) until it stops.

(3) Release the center pull handle to engage the slide lock pins and lock the litter slide in place.

l. Load the second casualty in the same manner as the first on the lower left litter system.

m. Slide the litter along the lower left litter system tracks until the litter weight is fully supported and the forward stirrups contact the front stop.

n. Lock the stirrups to the lower left litter system by engaging the front and rear litter lock mechanisms, visually confirming that the litter lock mechanisms pass through all four stirrups.

o. Pull the center pull handle to retract the slide lock pins. This will release the litter slide system and allow it to move.

p. Push the lower left litter system slide in towards the wall and release the center pull handle to engage the slide lock pins and lock the litter slide in place.

4. Configure the right side of the casualty compartment for litter casualties.

a. The first step in transitioning the litter system from the stowed configuration to any other patient load configuration is to rotate the right footrest into its functional position.

(1) Twist to unlock and pull to disengage the front and rear capture pins, on the right litter system seat, and rotate the footrest out.

(2) Push in and twist the two capture pins, on the right litter system seat, locking the footrest in the functional position.

**WARNING:** Failure of seated personnel to use designated footrests may result in injury.

Maintain positive physical control of vertical and horizontal portions of the litter system at all times while the capture pins are in the unlocked and out position.

b. Twist to unlock and pull to disengage the front and rear capture pins for the right litter system seat and rotate the right seat bottom to the down position.

c. Push to engage and twist to lock the forward and rear capture pins to lock the right seat bottom in the vertical position.

d. Remove and store the right seat back cushion.

e. Twist to unlock and pull to disengage the front and rear capture pins to unlock the right seat back, and rotate the right seat back into the right litter (horizontal) position.

f. Push to engage and twist to lock the forward and rear capture pins of the right litter system.

g. Slide out the right litter system.

(1) Pull the center pull handle to retract the slide lock pins. This will release the litter system slide and allow it to move.

(2) Pull the litter system slide out (towards the center of the patient compartment) until it stops.

(3) Release the center pull handle to engage the slide lock pins and lock the litter slide in place.

5. Load the litter casualties on the right litter system.

a. Load the third litter casualty in the same manner as the first two, on the upper and lower left litter systems.

b. Carry the casualty into the evacuation platform head first.

c. Place the litter stirrups, located at the casualty's head, in the litter system tracks.

d. Slide the litter along the tracks until the litter weight is fully supported and the forward stirrups contact the front stop.

e. Engage the front and rear litter lock mechanisms, visually confirming that the litter lock mechanisms pass through all four stirrups.

f. Pull the center pull handle to retract the slide lock pins. This will release the litter slide system and allow it to move.

g. Push the litter system slide in towards the wall and release the center pull handle to engage the slide lock pins and lock the litter slide in place.

6. Reconfigure the ramp to stairs.

a. Close the rear door.

b. While supporting the upper and middle ramp sections, disengage the locks.

c. Lower the top ramp section and allow the middle and lower ramp section to collapse.

d. Raise the middle and lower section parallel to the ground.

e. Disengage the retaining pin from the lower ramp step.

f. Rotate the lower ramp section back until the ramp steps point upwards.

g. Re-engage the retaining pin in the lower ramp step until the lower step locks into position.

h. Lift the middle ramp up and forward while simultaneously lowering the lower ramp section. This will result in the ramp section fan folding back into the original stowed configuration.

i. Engage the secure clamps from the upper ramp section with latches on the lower ramp section to lock the ramp in the stairs configuration.

**Evaluation Preparation:**

Setup: For training and evaluation, use a HAGA and four litter bearers.

Brief Soldier: Tell the Soldier there are multiple casualties that require loading into the HAGA. The Soldier will guide the litter bearers to correctly configure the HAGA for the casualties.

**Performance Measures**

	GO	NO GO
1 Configured the stairs to the ramp configuration.	_____	_____
2 Configured the left side of the casualty compartment for litter casualties.	_____	_____
3 Loaded the litter casualties on the left upper and left lower litter systems	_____	_____
4 Configured the right side of the casualty compartment for litter casualties.	_____	_____
5 Loaded the litter casualties on the right litter system.	_____	_____
6 Reconfigured the ramp to stairs.	_____	_____

**Evaluation Guidance:** Score each Soldier according to the performance measures. Unless otherwise stated in the task summary, the Soldier must pass all performance measures to be scored GO. If the Soldier fails any steps, show what was done wrong and how to do it correctly.

**References**

**Required**  
None

**Related**  
None



**Unload Casualties From a Mine Resistant Heavily Armored Ground Ambulance (HAGA)  
6x6 RG.33L**

**081-833-0291**

**Conditions:** You have completed transporting multiple litter and/or ambulatory casualties to a medical treatment facility (MTF). You are in charge of unloading litter and/or ambulatory casualties from a Heavily Armored Ground Ambulance (HAGA). You will need a HAGA armored ambulance and litter bearers. You are not in a CBRN environment.

**Standards:** Unload the HAGA in the correct sequence for the transport platform.

**Performance Steps**

**WARNING:** Moving or sliding interior components can pinch or crush fingers or hands. Ensure fingers or hands are clear of pinch points before adjusting equipment. Use provided handles to prevent injury. Failure to comply may result in injury to personnel.

1. Configure stairs to ramp.

**WARNING:** Ensure hands and feet are clear of the ramp. The upper section of the ramp will drop when the ramp is unfolded resulting in crushed or pinched body parts. Failure to comply may result in severe injury to personnel.

- a. Ensure that the ramp door is closed.
  - b. While supporting the ramp assembly, lift and release the secure clamps from the latches, allowing the ramp to be unfolded.
  - c. Unfold and straighten the lower ramp section from the middle ramp section.
  - d. Lift the middle and lower ramp section until they are parallel to the ground.
  - e. Disengage the retaining pin from the lower ramp section.
  - f. Rotate the ramp steps where the steps face the ground.
  - g. Re-engage the retaining pin in the lower ramp step until the step locks into position.
  - h. Lower the ramp until the bottom reversed step contacts the ground.
  - i. Lift the ramp and straighten the combined middle and lower section to the upper ramp section.
  - j. Make sure the locks are completely engaged with the pins on the middle ramp section.
  - k. Lower the entire ramp to make contact with the ground.
  - l. Open the rear door and lock into place.
2. Unload the litter casualties from the right litter system.
    - a. Pull the center pull handle to retract the slide lock pins. This will release the litter system slide and allow it to move.
    - b. Pull the litter system slide out (towards the center of the patient compartment) until it stops.
    - c. Release the center pull handle to engage the slide lock pins and lock the litter slide in place.

d. Disengage the front and rear litter lock mechanisms, visually confirming that the litter lock mechanism has disengaged from all four stirrups.

e. Have a litter bearer grab the litter handles at the casualty's feet and slowly walk towards the litter ramp.

f. Slide the litter along the litter system tracks until the front litter stirrups are approximately two inches from the end of the litter system tracks.

g. Have a second litter bearer grab the forward litter handles (near the head) and lift up on the head of the litter.

**CAUTION:** With the right litter system in the out position, the unloading of the litter from the litter system tracks should be performed with caution due to the limited space in the compartment and the angles the litter bearer, at the casualty's head, must turn his body to unload the litter stirrups from the litter system tracks.

h. Remove the stirrups completely from the litter system tracks and carry the litter casualty out of the patient compartment and down the litter ramp.

i. Have two additional litter bearers on each side of the litter ramp to support the sides of the litter as it descends the ramp.

j. Push in the right litter system.

(1) Pull the center pull handle to retract the slide lock pins. This will release the litter slide system and allow it to move.

(2) Push the litter system slide in towards the wall and release the center pull handle to engage the slide lock pins and lock the litter slide in place.

3. Stow the right side litter system.

**WARNING:** Maintain positive physical control of vertical and horizontal portions of the litter system at all times while the capture pins are in the unlocked and out position. Failure to comply may result in injury to personnel.

a. Twist to unlock and pull to disengage the front and rear capture pins to unlock the right seat back, and rotate the right seat back into the vertical position.

b. Push to engage and twist to lock the forward and rear capture pins to lock the right seat back in the vertical position.

c. Replace the right seat back cushion.

d. Twist to unlock and pull to disengage the front and rear capture pins for the right litter system seat and rotate the right seat bottom to the vertical position.

e. Push to engage and twist to lock the forward and rear capture pins to lock the right seat bottom in the vertical position.

f. Twist to unlock and pull to disengage the front and rear capture pins, on the right litter system seat, and rotate the footrest in.

g. Push in and twist the two capture pins, on the right litter system seat, locking the footrest in the stowed position.

4. Unload the litter casualties from the left litter systems.

a. Slide out the left lower litter system.

(1) Pull the center pull handle, on the bottom left litter system to retract the slide lock pins. This will release the litter system slide and allow it to move.

(2) Pull the bottom left litter system slide out (towards the center of the patient compartment) until it stops.

(3) Release the center pull handle to engage the slide lock pins and lock the litter slide in place.

b. Disengage the front and rear litter lock mechanisms, visually confirming that the litter lock mechanism has disengaged from all four stirrups.

c. Have a litter bearer grab the litter handles at the casualty's feet and slowly walk towards the litter ramp.

d. Slide the litter along the litter tracks until the front litter stirrups are approximately two inches from the end of the litter tracks.

e. Have a second litter bearer grab the forward litter handles (near the head) and lift up on the head of the litter.

**CAUTION:** With the right litter system in the out position, the unloading of the litter from the litter system tracks should be performed with caution due to the limited space in the compartment and the angles the litter bearer, at the casualty's head, must turn his body to unload the litter stirrups from the litter system tracks.

f. Remove the stirrups completely from the litter system tracks and carry the litter casualty out of the patient compartment and down the litter ramp.

g. Have two additional litter bearers on each side of the litter ramp to support the sides of the litter as it descends the ramp.

h. Push in the left lower litter system.

(1) Pull the center pull handle to retract the slide lock pins. This will release the litter slide system and allow it to move.

(2) Push the litter system slide in towards the wall and release the center pull handle to engage the slide lock pins and lock the litter slide in place.

i. Turn the master power switch (located up in the driver's compartment) to the on position.

j. Locate the push button assembly which is located on either left front or right rear of the patient compartment.

k. In case of a power failure (manual lowering):

(1) Press and hold the litter lift up button on the push button assembly.

(2) Release the motor brake by turning the brake switch on the drive motor counterclockwise.

(3) Attach a 1/2 inch square drive socket wrench to the left front of the litter lift manual drive and rotate the driveshaft counter clockwise to lower the left upper litter system.

l. Lower the litter.

m. Slide out the upper left litter system.

(1) Pull the center pull handle to retract the slide lock pins. This will release the litter system slide and allow it to move.

(2) Pull the litter system slide out (towards the center of the patient compartment) until it stops.

(3) Release the center pull handle to engage the slide lock pins and lock the litter slide in place.

n. Disengage the front and rear litter lock mechanisms, visually confirming that the litter lock mechanism has disengaged from all four stirrups.

o. Have a litter bearer grab the litter handles at the casualty's feet and slowly walk towards the litter ramp.

p. Slide the litter along the litter tracks until the front litter stirrups are approximately two inches from the end of the litter tracks.

q. Have a second litter bearer grab the forward litter handles (near the head) and lift up on the head of the litter.

**CAUTION:** With the right litter system in the out position, the unloading of the litter from the litter system tracks should be performed with caution due to the limited space in the compartment and the angles the litter bearer, at the casualty's head, must turn his body to unload the litter stirrups from the litter system tracks.

r. Remove the stirrups completely from the litter system tracks and carry the litter casualty out of the patient compartment and down the litter ramp.

s. Have two additional litter bearers on each side of the litter ramp to support the sides of the litter as it descends the ramp.

t. Push in the left lower litter system.

(1) Pull the center pull handle to retract the slide lock pins. This will release the litter slide system and allow it to move.

(2) Release the center pull handle to engage the slide lock pins and lock the litter slide in place.

5. Stow the left side litter systems.

**WARNING:** Maintain positive physical control of vertical and horizontal portions of the litter system at all times while the capture pins are in the unlocked and out position. Failure to comply may result in injury to personnel.

a. Twist to unlock and pull to disengage the front and rear capture pins to unlock the upper left litter system, and rotate the left upper litter system into the vertical position.

b. Push to engage and twist to lock the forward and rear capture pins to lock the upper left litter system in the vertical position.

c. Twist to unlock and pull to disengage the front and rear capture pins for the left lower litter system seat back and rotate the left lower seat back to the vertical position.

d. Replace the right seat back cushion.

e. Twist to unlock and pull to disengage the front and rear capture pins for the left lower litter system seat and rotate the left seat bottom to the vertical position.

f. Push to engage and twist to lock the forward and rear capture pins to lock the left lower litter system seat bottom in the vertical position.

g. Twist to unlock and pull to disengage the front and rear capture pins, on the left lower litter system seat, and rotate the footrest in.

h. Push in and twist the two capture pins, on the left lower litter system seat, locking the footrest in the stowed position.

**Evaluation Preparation:**

Setup: For training and evaluation, use a HAGA loaded with litter casualties and additional Soldiers for litter bearers.

Brief Soldier: Tell the Soldier the casualties need to be offloaded from the HAGA.

<b>Performance Measures</b>	GO	NO GO
1 Configured the stairs to the ramp configuration.	_____	_____
2 Unloaded the litter casualties from the right litter system.	_____	_____
3 Stowed the right side litter system.	_____	_____
4 Unloaded the litter casualties from the left litter systems.	_____	_____
5 Stowed the left side litter systems.	_____	_____

**Evaluation Guidance:** Score each Soldier according to the performance measures. Unless otherwise stated in the task summary, the Soldier must pass all performance measures to be scored GO. If the Soldier fails any steps, show what was done wrong and how to do it correctly.

**References**

**Required**  
None

**Related**  
None

## Prepare a Skedko® for Hoist Operations

081-833-0299

**Conditions:** You are deployed to a unit in a forward area in terrain that will only allow medical evacuation by helicopter rescue hoist. You have a litter casualty that must be packaged in a Sked stretcher for a hoist extraction. You will need a Skedco stretcher assemblage. You are not in a CBRN environment.

**Standards:** Package a patient for a rescue hoist extraction in a Sked stretcher without causing injury to the casualty.

### Performance Steps

1. Evaluate the casualty according to the tactical situation and determine if a spinal injury is suspected. (See task 081-833-0053.)

*NOTE:* If a spinal injury is suspected, the patient should be immobilized with a short spine board prior to being placed in the Sked stretcher. (See task 081-833-0096.)

2. Open the cordura backpack and remove the rolled Sked stretcher and place on the ground.

3. Unroll completely to the opposite end (head end) of the stretcher.

a. While keeping your foot on the foot end of the stretcher, pull the head end of the stretcher up to your chest and bend the Sked stretcher in half (away from you) and back roll.

b. Place your foot on the head end of the Sked stretcher while pulling the foot end of the stretcher up to your chest and bend the Sked stretcher in half and back roll.

*NOTE:* Laying the Sked stretcher out in this manner is important in order for the Sked stretcher to lay flat on the ground.

4. Insert horizontal lift slings.

a. Insert the horizontal lift sling, labeled head strap, thru the angled lift slot at the head of the stretcher located just inferior to the first cross strap. Starting from the inside thru to the outside of the Sked stretcher.

b. Run the horizontal lift sling around the outside of the Sked stretcher to the opposite angled lift slot.

c. Insert the horizontal lift sling thru the angled lift slot, located closest to the third cross strap, from the outside in.

d. Extend both ends of the horizontal lift slings and ensure that both have equal length.

e. Insert the horizontal lift sling, not labeled head strap, thru the angled lift slot at the foot end of the stretcher starting from the inside thru to the outside of the Sked stretcher.

f. Run the horizontal lift sling around the outside of the Sked stretcher to the opposite angled lift slot.

g. Insert the horizontal lift sling thru the angled lift slot from the outside in.

h. Extend both ends of the horizontal lift slings and ensure that both have equal length.

5. Slide the casualty onto the Sked stretcher.

a. Place the foot of the Sked stretcher at the top of the casualty's head.

*NOTE:* Ensure that the four cross straps are not laying on the stretcher surface so that they do not lie under the casualty when the casualty is applied to the stretcher.

- b. Slide and center the casualty onto the Sked stretcher.
  6. Buckle the cross straps.
    - a. Lift the sides of the Sked stretcher and feed the four cross straps to the buckles directly opposite the cross straps.
    - b. Pull the four cross straps until each one is secured thru the buckles.
    - c. Half hitch (tie excess in a series of half knots) and tuck the excess on the inside of the Sked stretcher with the casualty.
  7. Buckle the foot straps.
    - a. Feed the foot straps thru the unused grommets, located closest to the fourth cross strap, at the foot end of the Sked stretcher.
    - b. Buckle the two foot straps and fasten securely.
    - c. Half hitch (half knot) and tuck the excess on the inside of the Sked stretcher with the casualty.
  8. Prepare the head portion of the Sked stretcher for hoist operations.
    - a. Bend the head portion of the Sked stretcher over the casualty and remove the excess slack, from the drag strap, until the stretcher maintains its curve over the casualty's head.
    - b. Tie the drag strap to the middle of the second cross strap in a half knot.
    - c. Tuck the excess of the drag strap into the stretcher with the casualty.
- NOTE:* sure that the curved portion of the stretcher, at the casualty's head, doesn't make contact with casualty's skin. This will prevent further injury to the casualty during actual hoisting of the stretcher.
9. Insert the large locking 'D' steel carabineer.
    - a. Insert the large locking 'D' steel carabineer thru one of the open ends of the head horizontal lift slings.
    - b. Insert the large locking 'D' steel carabineer thru both open ends of the foot horizontal lift slings.
    - c. Insert the large locking 'D' steel carabineer thru the remaining head horizontal lift sling.
    - d. Screw down the gate screw completely and lock it in place.
  10. Perform final checks.
    - a. Check all four cross straps.
    - b. Check the two foot straps.
    - c. Ensure that the horizontal lift strap labeled head strap is actually at the head of the Sked stretcher.
    - d. Ensure that all four horizontal lift slings are even in length so the load will be lifted evenly.
    - e. Ensure that the large locking 'D' steel carabineer has been feed thru all four ends of the horizontal lift slings.
    - f. Ensure that gate screw on the large locking 'D' steel carabineer has been screwed down completely and the keeper is not able to freely open.

**Evaluation Preparation:**

Setup: For training and evaluation, use a Soldier to be a simulated casualty.

Brief Soldier: Tell the testing Soldier the simulated casualty requires placement on a Sked for hoist operations and evacuation.

<b>Performance Measures</b>	GO	NO GO
1 Evaluated the casualty according to the tactical situation and determined if a spinal injury is suspected.	_____	_____
2 Opened the cordura backpack and removed the rolled Sked stretcher and placed on the ground.	_____	_____
3 Unrolled completely to the opposite end (head end) of the stretcher.	_____	_____
4 Inserted horizontal lift slings into the appropriate angled lift slot.	_____	_____
5 Slid the casualty onto the Sked stretcher.	_____	_____
6 Buckled cross straps correctly.	_____	_____
7 Buckled the foot straps correctly.	_____	_____
8 Prepared the head portion of the Sked stretcher for hoist operations.	_____	_____
9 Inserted the large locking 'D' steel carabineer.	_____	_____
10 Performed final checks.	_____	_____

**Evaluation Guidance:** Score each Soldier according to the performance measures. Unless otherwise stated in the task summary, the Soldier must pass all performance measures to be scored a GO. If the Soldier fails any steps, show them what was done wrong and how to do it correctly.

**References**

**Required**  
None

**Related**  
None



## Unload Casualties From a UH-60 Series Helicopter

081-833-0294

**Conditions:** A UH-60 series helicopter has arrived at your medical treatment facility (MTF) and you are in charge of unloading the litter and ambulatory patients. You will need a UH-60 series helicopter with a medical evacuation kit installed, four litters, eight litter straps and four nonmedical Soldiers to act as litter bearers. You are not in a CBRN environment.

**Standards:** Unload the UH-60 series helicopter in the correct sequence without causing further injury.

### Performance Steps

1. Follow the principles of unloading casualties from a rotary-wing aircraft.
  - a. Responsibility for unloading a rotary-wing aircraft.
    - (1) The pilot in command has the overall responsibility for the proper unloading of the aircraft, as well as, all safety considerations inside and around the aircraft.
    - (2) The flight medic is responsible for ensuring that the litter squad follows the prescribed methods for unloading litter and ambulatory casualties and securing litters and related medical equipment.
    - (3) The flight medic also determines which casualties are unloaded first.
  - b. Safety measures.
    - (1) Litter bearers must present as low a silhouette as possible and must keep clear of the main and tail rotors at all times.
    - (2) The helicopter must not be approached until a crewmember signals to do so.
    - (3) The litter bearers should approach the aircraft at a 90 degree angle from the side of the helicopter ensuring that no litter bearers pass behind the cargo doors of the aircraft.
    - (4) If the helicopter is on a slope and conditions permit, unloading personnel should approach the aircraft from the downhill side.
    - (5) Directions given by the crew must be followed, and litters must be carried parallel to the ground.
    - (6) All patient equipment such as blankets should be secured to the litter to prevent any potential damage to the aircraft.
    - (7) Smoking is not permitted within 50 feet of the aircraft.
2. Unload casualties from the rotary-wing aircraft.
  - a. When off loading casualties from a UH-60 series helicopter, follow all guidance from the helicopter crew members.
  - b. The litter support unit (pedestal) is rotated 90 degrees clockwise to unload the casualties.
  - c. The unloading sequence for the four litter configuration.
    - (1) On the right side of the aircraft, the unloading sequence is bottom right, bottom left, top right and top left.

(2) If you are unloading from the left side of the aircraft, the unloading sequence is bottom left, bottom right, top left and top right.

d. The unloading sequence for the six litter configuration.

(1) Remove the casualty that has been placed on the floor on the left side.

(2) Remove the casualty that has been placed on the floor of the right side.

(3) Turn the litter support unit 90 degrees.

(4) Once the litter support unit has been turned 90 degrees the last four litters are unloaded in the normal sequence.

3. Do not cause further injury to the casualties.

**Evaluation Preparation:**

Setup: For training and evaluation, utilize a UH 60 or a UH 60 mockup. Utilize four Soldiers as litter casualties and have four litter bearers that the Soldier being evaluated can give directed to and supervise the off loading of casualties.

**Performance Measures**

	GO	NO GO
1 Followed the principles of unloading casualties from a rotary wing aircraft.	_____	_____
2 Directed nonmedical Soldiers to unload casualties in the proper sequence.	_____	_____
3 Did not cause further injury to the casualties.	_____	_____

**Evaluation Guidance:** Score each Soldier according to the performance measures. Unless otherwise stated in the task summary, the Soldier must pass all performance measures to be scored GO. If the Soldier fails any steps, show what was done wrong and how to do it correctly.

**References**

**Required**  
None

**Related**  
TM 1-1520-237-10

## Transport a Casualty Using a Litter

**081-833-0298**

**Conditions:** You have completed triaging and treating a casualty. You are in charge of placing the casualty onto a litter and transporting to an evacuation vehicle. You will need a litter and two patient securing straps. You are not in a CBRN environment.

**Standards:** Transport a casualty using a litter without causing further injury to the casualty.

### Performance Steps

1. Prepare the litter for the casualty.
  - a. Unfasten both litter straps.
  - b. Stand the litter on one end and pull open.
  - c. Using one foot, lock the bottom spreader bar open.
  - d. Rotate the litter into a standing position with the opposite end on the ground.
  - e. Using one foot, lock the second spreader bar open.
  - f. Lower the litter to the ground with the canvas (mesh) side in the up position.

**WARNING:** When moving a casualty onto a litter, the casualty must be wearing an Army Combat Helmet (ACH) unless the casualty's wounds prevent the use of an ACH.

2. Load a casualty onto a litter.
  - a. Have three litter bearers kneel at the casualty's side.

*NOTE:* Have a litter bearer face the casualty and kneel at the casualty's shoulders, hips and ankles at the same side of the casualty.

- b. Have the litter bearers place their arms under the casualty's shoulders, back, hips and lower legs carefully supporting the casualty's neck and body.
  - c. All bearers lift the casualty to their chests while supporting the casualty on one knee.
  - d. Have the fourth litter bearer place the litter below the casualty on the ground.
  - e. The fourth litter bearer supports the opposite side of the casualty while the casualty is lowered slowly to the litter.
  - f. Slowly lower the casualty onto the litter.
  - g. Secure the casualty to the litter by applying a patient securing strap around the chest of the casualty and the litter, as well as a patient securing strap around the knees of the casualty and the litter.

3. Transport a casualty using a litter.

- a. Four man carry.
  - (1) Have a litter bearer stand at each handle of the litter(four litter bearers total).
  - (2) Each position is numbered from 1 to 4.
    - (a) The position at the right side of the casualty's head is the number 1 position and is the Squad Leader. All commands come from the number 1 litter bearer.
    - (b) The position at the casualty's right foot is the number 2 litter bearer.
    - (c) The position at the left side of the casualty's head is the number 3 litter bearer.

(d) The position at the casualty's left foot is the number 4 litter bearer.

(3) Have all four litter bearers face toward the casualty's feet, kneel and grab the litter handles.

(4) The number 1 position gives the preparatory command "Prepare to Lift" and the command of execution "Lift".

(5) Upon the command of execution "lift", all four litter bearers will stand simultaneously.

(6) The direction of travel for the patient is feet first on level terrain.

(7) Once the litter is lifted off of the ground and all four litter bearers are standing, the command to proceed is "Four Man Carry, Move."

b. Two-man carry.

*NOTE:* The two man carry is given when passing through or over narrow passages such as trails, bridges, gangplanks, culverts and catwalks.

(1) The preparatory command is "Two Man Carry" and the command of execution is "Move."

(2) Upon the preparatory command "Two Man Carry", the number 3 litter bearer adjusts his hold and grabs both litter handles at the casualty's head.

(3) At the same time, the number 2 litter bearer (while facing in the direction of travel) adjusts his hands and grabs both litter handles at the casualty's feet.

(4) Simultaneously, the number 1 litter bearer releases his grasp of the litter handle (once the number 3 litter bearer has securely grasped both handles) and moves to one pace in front of the number 2 litter bearer (this position is in the lead).

(5) Simultaneously, the number 4 litter bearer releases his grasp of the litter handle (once the number 2 litter bearer has securely grasped both handles) and moves to one pace behind the number three litter bearer (located in the rear of the litter team).

(6) Upon the command of execution "Move" the litter team moves out.

c. Litter post carry.

(1) The command "Litter Post Carry, Move" is given to enable the litter squad to move over rough terrain.

(2) The preparatory command is "Litter Post Carry" and the command of execution is "Move."

(3) Upon the preparatory command "Litter Post Carry", the number 3 litter bearer grasps the handles of the litter at the casualty's head while the number 2 litter bearer grasps the handles of the litter at the casualty's feet (facing the direction of travel).

(4) Simultaneously, litter bearers number 1 and 4 release their holds and move to the sides of the litter.

(5) Once litter bearers 1 and 4 have positioned themselves on the sides of the litter, they grasp the sides of the litter and assist in supporting the weight of the casualty.

(6) Once all litter bearers are in position, the number 1 litter bearer gives the command of execution "Move" and the litter team moves out.

d. Uphill carry.

(1) When carrying a casualty uphill or up stairs, the casualty should be transported head first. The litter must be turned to accomplish this.

**NOTE:** If the casualty has a leg splint then the casualty should be transported feet first.

(2) The command “Litter Post Carry” is given.

(3) Once the litter team is in the litter post carry positions the next preparatory command is “prepare to rotate.”

(4) The number 2 and 3 litter bearers let go of the litter handles and step back.

(5) Once the command of execution “rotate” is given, the number 1 and 4 litter bearers will rotate the litter 180 degrees counter clockwise, which will place the casualty’s head toward the direction of travel.

(6) Once the rotation is complete the number 2 and 3 litter bearers will grasp the handles.

(7) Once the command “Up Hill Carry” is given, the number 4 litter bearer will move to the foot of the litter and take one of the handles released by the number 3 litter bearer.

(8) The number 1 litter bearer will move to the front of the litter team and lead the litter team forward.

e. Downhill carry.

(1) When carrying a casualty downhill or down stairs, the casualty should be transported feet first.

(2) With the litter squad in the four-man carry, the preparatory command “Downhill Carry” is given.

(3) The litter bearer number 3 will grasp both litter handles and support the litter at the patient’s head.

(4) Simultaneously, the number 1 litter bearer moves to the front, facing the squad.

(5) Litter bearer number 1 supports litter bearers number 2 and 4 and ensures that the litter remains level.

4. Do not cause further harm to the casualty.

**Evaluation Preparation:**

Setup: For training and evaluation, use a Soldier as a casualty and 4 other Soldiers as litter bearers.

Brief Soldier: Tell the Soldier the simulated casualty requires transport on a litter.

<b>Performance Measures</b>	GO	NO GO
1 Prepared the litter for the casualty.	_____	_____
2 Loaded the casualty onto the litter.	_____	_____
3 Transported a casualty using a litter.	_____	_____
4 Did not cause further harm to the casualty.	_____	_____

**Evaluation Guidance:** Score each Soldier according to the performance measures. Unless otherwise stated in the task summary, the Soldier must pass all performance measures to be scored GO. If the Soldier fails any steps, show what was done wrong and how to do it correctly.

**References**

**Required**  
None

**Related**  
None

## **Triage Casualties**

**081-833-0281**

**CAUTION:** All body fluids should be considered potentially infectious. Always observe body substance isolation (BSI) precautions by wearing gloves and eye protection as a minimal standard of protection.

**Conditions:** You have several casualties requiring triage. You will need a pen and a DD Form 1380 US Field Medical Card (FMC). You have taken body substance isolation (BSI) precautions. You are not in a CBRN environment.

**Standards:** Complete all the steps necessary to establish priorities for treatment and the evacuation of casualties.

### **Performance Steps**

1. Assess the situation.
    - a. Sort the casualties and allocate treatment based on the resources available.
      - (1) Assess and classify the casualties for the most efficient use of available medical personnel and supplies.
      - (2) Give available treatment first to the casualties who have the best chance of survival.
      - (3) A primary goal is to locate, and return to duty, troops with minor wounds; however, at no time should abandonment of a single casualty be considered.
      - (4) Triage establishes the order of treatment, not whether treatment is given. It is usually the responsibility of the senior medical person present.
    - b. Determine the tactical and environmental situation.
      - (1) Whether casualties must be transported to a more secure area for treatment.
      - (2) The number and location of the injured and the severity of the injuries.
      - (3) Available assistance (self-aid, buddy-aid, combat lifesaver, and medical personnel).
      - (4) Evacuation support capabilities and requirements.
  2. Assess the casualties and establish priorities for treatment.
    - a. Immediate-casualties whose conditions demand immediate treatment to save life, limb or eyesight. This category has the highest priority.
      - (1) Airway obstruction.
      - (2) Respiratory and cardiorespiratory distress from otherwise treatable injuries (for example, electrical shock, drowning or chemical exposure).
- NOTE:* A casualty with cardiorespiratory distress may not be classified "Immediate" on the battlefield. This casualty may be classified "Expectant", contingent upon such things as the situation, number of casualties, and available support.
- (3) Massive external bleeding.
  - (4) Shock.
  - (5) Burns on the face, neck, hands, feet, perineum or genitalia.

*NOTE:* After all life- or limb-threatening conditions have been successfully treated; give no further treatment to the casualty until all other "Immediate" casualties have been treated. Salvage of life always takes priority over salvage of limb.

b. Delayed-casualties who have less risk of loss of life or limb if treatment is delayed.

- (1) Open wounds of the chest without respiratory distress.
- (2) Open or penetrating abdominal injuries without shock.
- (3) Severe eye injuries without hope of saving eyesight.
- (4) Other open wounds.
- (5) Fractures.

(6) Second and third degree burns (not involving the face, hands, feet, genitalia, and perineum) covering 20% or more of the total body surface area (TBSA).

c. Minimal-"walking wounded", can be treated by self-aid or buddy-aid.

- (1) Minor lacerations and contusions.
- (2) Sprains and strains.
- (3) Minor combat stress problems.

(4) First or second degree burns (not involving the face, hands, feet, genitalia, and perineum) covering under 20% of the TBSA.

*NOTE:* Minimal casualties may assist the Soldier Medic by providing buddy-aid or by monitoring other casualties.

d. Expectant-casualties who are so critically injured that only complicated and prolonged treatment can improve life expectancy. This category is to be used only if resources are limited. If in doubt as to the severity of the injury, place the casualty in one of the other categories.

- (1) Massive head injuries with signs of impending death.
- (2) Burns, mostly third degree, covering more than 85% of the TBSA.

*NOTE:* Provide ongoing supportive care if the time and condition permit; keep separate from other triage categorized casualties. (See common core task 101-515-0002.)

3. Record all treatment given on the FMC. (See task 081-831-0033.)

4. Establish MEDEVAC priorities by precedence category.

a. Urgent. Evacuation is required as soon as possible, but within 1 hour, to save life, limb or eyesight. Generally, casualties whose conditions cannot be controlled and have the greatest opportunity for survival are placed in this category.

- (1) Cardiorespiratory distress.
- (2) Shock not responding to IV fluid therapy.
- (3) Prolonged unconsciousness.
- (4) Head injuries with signs of increasing intracranial pressure.
- (5) Burns covering 20% to 85% of the TBSA.

b. Urgent Surgical. Evacuation is required for casualties who must receive far forward surgical intervention to save life and stabilize for further evacuation.

- (1) Decreased circulation in the extremities.

- (2) Open chest and/or abdominal wounds with decreased blood pressure.
- (3) Penetrating wounds.
- (4) Uncontrollable hemorrhage or open fractures with severe hemorrhage.
- (5) Severe facial injuries.

c. Priority. Evacuation is required within 4 hours or the casualty's condition could get worse and become an "Urgent" or "Urgent Surgical" category condition. Generally, this category applies to any casualty whose condition is not stabilized or who is at risk of trauma-related complications.

- (1) Closed-chest injuries, such as rib fractures without a flail segment or other injuries that interfere with respiration.
- (2) Brief periods of unconsciousness.
- (3) Soft tissue injuries and open or closed fractures.
- (4) Abdominal injuries without hypotension.
- (5) Eye injuries that do not threaten eyesight.
- (6) Spinal injuries.
- (7) Burns on the hands, face, feet, genitalia, or perineum, even if under 20% of the TBSA.

d. Routine. Evacuation is required within 24 hours for further care. Immediate evacuation is not critical. Generally, casualties who can be controlled without jeopardizing their condition or who can be managed by the evacuating facility for up to 24 hours.

- (1) Burns covering 20% - 80% of the TBSA if the casualty is receiving and responding to IV fluid therapy.
- (2) Simple fractures.
- (3) Open wounds including chest injuries without respiratory distress.
- (4) Behavioral emergencies and combat stress casualties.
- (5) Terminal cases.

e. Convenience. Evacuation by medical vehicle is a matter of convenience rather than necessity.

- (1) Minor open wounds.
- (2) Sprains and strains.
- (3) Minor burns under 20% of TBSA.

5. Prepare a medical evacuation request. (See STP 21-24-SMCT, task 081-831-0101.)

### **Evaluation Preparation:**

Setup: For training and evaluation construct a scenario that involves multiple combat casualties. Moulaged Soldiers may be used as casualties. Brief each Soldier as to their wounds and what their actions should be when assessed. Tell the casualties not to assist the Soldier in any way; unless they are designated as "minimal" casualties and instructed to provide buddy-aid.

Brief the Soldier: Tell the Soldier to assess the situation and the casualties, establish priority of treatment, establish MEDEVAC priorities, and prepare the evacuation request.



**Performance Measures**

	GO	NO GO
1 Assessed the situation.	_____	_____
2 Assessed the casualties and established priorities for treatment.	_____	_____
3 Recorded the treatment given on the FMC.	_____	_____
4 Established MEDEVAC priorities by precedence category.	_____	_____
5 Prepared a medical evacuation request.	_____	_____

**Evaluation Guidance:** Score each Soldier according to the performance measures. Unless otherwise stated in the task summary, the Soldier must pass all performance measures to be scored GO. If the Soldier fails any steps, show what was done wrong and how to do it correctly.

**References**

**Required**

DD Form 1380

**Related**

ATTP 4-02  
STP 21-24-SMCT

## Subject Area 10: Medication Administration

### Prepare an Injection for Administration

081-833-0088

**Conditions:** You must prepare an injection for administration. You will need needles and syringes, medication, alcohol sponges, dry sterile gauze, and a medical officer's order. You have performed a patient care handwash. You are not in a CBRN environment.

**Standards:** Select, inspect, and assemble the appropriate needle and syringe. Draw the correct medication. Follow aseptic technique throughout the procedure.

#### Performance Steps

1. Select an appropriate needle.

a. Select a needle with the proper length based upon the following factors:

(1) The type of injection to be given (subcutaneous, intramuscular, or intradermal).

(2) The size of the patient (thin, obese).

(3) The injection site (1 inch for deltoid, 1 1/2 inches for gluteus maximus).

b. Select a needle with the proper gauge based upon the thickness of the medication to be injected.

*NOTE:* The gauge of the needle is indicated by the numbers 10 through 27. The higher the number, the smaller the diameter (bore) of the needle. A small bore needle is indicated for thin medications. A large bore needle is indicated for thick medications.

2. Select an appropriate syringe.

a. Check the drug manufacturer's specifications to determine whether a glass or plastic syringe should be used for the medication.

*NOTE:* Some medications deteriorate in a plastic syringe. Drug manufacturer's specifications provide guidance.

b. Ensure that the total capacity of the syringe, usually measured in cubic centimeters (cc), is appropriate for the amount of medication to be administered.

c. Check the intervals of the calibration marks on the syringe.

3. Inspect the needle and syringe packaging for defects such as open packages, holes, and water spotting.

*NOTE:* Discard the equipment if any defect is found.

4. Unpack the syringe.

a. If the syringe is in a flexible wrapper, peel the sides of the wrapper apart to expose the rear end of the syringe barrel.

**CAUTION:** The needle adapter and the shaft of the plunger are sterile. Contamination could cause infection in the patient. The outside of the syringe barrel does not have to be kept sterile.

b. Grasp the syringe by the barrel with the free hand.

c. Pull the syringe from the packaging.

d. If the syringe is packaged in a hard plastic tube container, press down and twist the cap until a distinct "pop" is heard. If the "pop" is not heard, the seal has been previously broken and the equipment must be discarded.

## 5. Inspect the syringe.

- a. Grasp the flared end of the syringe and pull the plunger back and forth to test for smooth, easy movement.
- b. Visually check the rubber stopper (inside the syringe) to ensure that it is attached securely to the top end of the plunger, forming a seal.
- c. If the plunger is stuck or does not move smoothly, discard the syringe.
- d. Push the plunger fully into the barrel until ready to fill the syringe with medication.

**CAUTION:** All parts of the needle are sterile. Be careful not to touch the hub. This would contaminate the needle and possibly pass an infection to the patient. Only the outside of the needle cover may be touched.

## 6. Unpack the needle.

- a. If the needle is packaged in a flexible wrapper, peel the sides of the wrapper apart to expose the needle hub.
- b. If the needle is packaged in a hard plastic tube, twist the cap of the tube until a "pop" is heard. Remove the cap to expose the needle hub. If a "pop" is not heard, the seal has been previously broken, and the equipment must be discarded.

## 7. Join the needle and the syringe.

- a. Insert the needle adapter of the syringe into the hub of the needle.
- b. Tighten the needle by turning 1/4 of a turn to ensure that it is securely attached.

## 8. Inspect the needle.

- a. Hold the needle and syringe upright and remove the protective cover from the needle by pulling it straight off.

*NOTE:* A twisting motion may pull the needle off the hub.

- b. Visually inspect the needle for burrs, barbs, damage, and contamination. If the needle has any defects or damage, replace it with another sterile needle.
- c. Place the protective cover back on the needle utilizing the "scoop" method.

## 9. Place the assembled needle and syringe on the work surface.

- a. Leave the protective cover on the needle.
- b. Leave the plunger pushed fully into the barrel.
- c. Keep the assembled needle and syringe continually within range of vision.

*NOTE:* When you assemble a needle and syringe, you are responsible for maintaining sterility and security of the equipment.

## 10. Verify the drug label and check the container for defects.

- a. Compare the medication with the medical officer's orders. The medication label must be verified three times.

- (1) When obtained from the place of storage.
- (2) When withdrawing the medication.
- (3) When returning the container to storage.

- b. Examine the container.

(1) Examine the rubber stopper for defects, such as small cores or plugs torn from the stopper.

(2) Hold the vial to the light to check for foreign particles and changes in color and consistency. If the solution is in a dark vial, withdraw some solution to perform the checks.

(3) Check the date multidose vial was opened and check the expiration date of the medication.

(4) Determine whether the medication was stored properly, such as under refrigeration.

*NOTE:* If there is any evidence of contamination, discard the container and obtain another.

11. Prepare and draw the medication.

a. Draw medication from a stoppered vial which contains a prepared solution.

(1) Remove the protective cap.

(2) Clean the stopper and neck of the vial with an alcohol sponge.

(3) Pick up the assembled needle and syringe and remove the protective needle cover.

(4) Slowly draw the plunger to the prescribed cc mark of medication.

(5) Pick up the vial and insert the needle into the rubber stopper, exerting slight downward and forward pressure. Ensure that the needle tip passes completely through the cap.

*NOTE:* To avoid contamination, the hub of the needle should not touch the rubber cap.

(6) Push the plunger fully into the barrel to inject the air.

(7) With the vial inverted (and keeping the needle tip in the solution), pull the plunger back to the desired cc mark, withdrawing the medication.

(8) Withdraw the needle from the container.

(9) Verify the correct dosage against the medical officer's orders by raising the syringe to eye level and ensuring that the forward edge of the plunger is exactly on the prescribed cc mark.

b. Draw medication from a stoppered vial which contains a powdered medication which must be prepared.

(1) Remove the protective caps from the vial containing the powdered medication and the vial containing the sterile diluent.

(2) Clean the stoppers of both vials with alcohol sponges.

(3) Withdraw the required diluent, using the same procedure as for a stoppered vial. (See steps 11a(3) through 11a(8).)

(4) Hold the vial with the powdered medication horizontally, insert the needle through the stopper, and inject the diluent.

*NOTE:* If the vial with powdered medication contains air, the diluent may be difficult to inject. Air may have to be withdrawn to allow the diluent to be injected.

(5) Withdraw the needle.

(6) Gently invert the vial several times until all the powder is dissolved. Visually inspect the solution to ensure that it is well-mixed.

(7) Change the needle (or needle and syringe) and insert it into the vial of reconstituted solution.

- (8) Withdraw the prescribed amount of medication. (See step 11a(7).)
- (9) Withdraw the needle from the container.
- (10) Verify the correct dosage. (See step 11a(9).)
- c. Draw medication from an ampule.
  - (1) Lightly tap the upright ampule to force any trapped medication from the ampule neck and top.
  - (2) Clean the neck of the ampule with an alcohol sponge and wrap it with the same sponge.
  - (3) Grasp the ampule with both hands and snap the neck by bending it away from the break line, directing it away from yourself and others.
  - (4) Inspect the ampule for minute glass particles. If any are found, discard the ampule.
  - (5) Remove the protective cover from the assembled needle and syringe.
  - (6) Insert the needle and withdraw the medication by holding the ampule vertically or by placing the ampule upright on a flat surface.
  - (7) Withdraw the prescribed medication, being careful not to touch the outside edge or bottom of the ampule with the needle.
  - (8) Withdraw the needle.
  - (9) Verify the correct dosage. (See step 11a(9).)
12. Check the syringe for air bubbles.
  - a. Hold the syringe with the needle pointing up.
  - b. Pull back on the plunger slightly to clear all the medication from the needle shaft.
  - c. Tap the barrel lightly to force bubbles to the top of the barrel.
  - d. Pull the plunger back slightly and push it forward until the solution is in the needle hub, clearing it of bubbles.
13. Reverify the correct dosage. (See step 11a(9).)
14. Cover the needle with the protective needle cover utilizing the "scoop" (one-handed technique) method.
  - a. Place the needle cover on flat surface.
  - b. Hold syringe in the dominant hand, scoop the needle cap onto the needle.
  - c. Tip syringe vertically to slide cover over needle.
  - d. Do NOT hold onto the needle cap with non-dominant hand while scooping. Keep nondominant hand well away from needle cap.
  - e. Secure the needle cap by grasping it near the hub.
15. Do not violate aseptic technique.

**Evaluation Preparation:**

Setup: If the performance task must be simulated for training and evaluation, colored solutions may be used to simulate medications. Have several sizes of needles and syringes available. Tell the Soldier what type of medication is being simulated and what the route of administration

would be. Have Soldier select the appropriate needle and syringe. To test step 2, tell the Soldier of any manufacturer specifications. Testing may be varied by using various medications to be administered by different routes.

Brief Soldier: Tell the Soldier to assemble the proper needle and syringe and draw up the medication.

<b>Performance Measures</b>	GO	NO GO
1 Selected the appropriate needle.	_____	_____
2 Selected the appropriate syringe.	_____	_____
3 Inspected the needle and syringe packaging for defects such as open packages, holes, and water spotting.	_____	_____
4 Unpacked the syringe.	_____	_____
5 Inspected the syringe.	_____	_____
6 Unpacked the needle.	_____	_____
7 Attached the needle and syringe.	_____	_____
8 Inspected the needle.	_____	_____
9 Placed the assembled needle and syringe on the work surface.	_____	_____
10 Verified the drug label and checked the medication container for defects.	_____	_____
11 Prepared and drew the medication.	_____	_____
12 Checked the syringe for air bubbles.	_____	_____
13 Re-verified the correct dosage.	_____	_____
14 Covered the needle with the protective needle cover utilizing the "scoop" (one-handed technique) method.	_____	_____
15 Did not violate aseptic technique.	_____	_____

**Evaluation Guidance:** Score each Soldier according to the performance measures. Unless otherwise stated in the task summary, the Soldier must pass all performance measures to be scored GO. If the Soldier fails any steps, show what was done wrong and how to do it correctly.

**References**

**Required**  
None

**Related**  
None

## Administer an Intramuscular Injection

081-833-0301

**Conditions:** You have a patient that requires an intramuscular injection. You will need syringe(s) with the prepared medication(s), antiseptic pads, alcohol sponge swabs, sterile gauze, adhesive tape, and the patient's record. You have performed a patient care handwash and have verified the medical officer's order. You are not in a CBRN environment.

**Standards:** Administer the injection in accordance (IAW) with the medical officer's order without violating aseptic technique or causing injury to the patient.

### Performance Steps

1. Verify the required injection(s) with the medical officer's order.

**WARNINGS:** 1. If there is a known allergy, do not administer the injection. Consult the medical officer. 2. Determine if a female patient is pregnant because of possible side effects of certain immunizing agents on the unborn child. If there is a question, do not administer the injection without written authorization.

2. Identify the patient by asking the patient's name and checking the identification tag or band.

3. Ask the patient if he/she has any allergies or has experienced a drug reaction.

**WARNING:** Have an emergency tray available for the immediate treatment of serious reactions. Include a constricting band and a syringe containing a 1:1000 solution of epinephrine.

4. Verify that the appropriate needle, syringe, and medication are being used. (See task 081-833-0088.)

5. Select and expose the injection site.

- a. The upper arm deltoid muscle-the outer 1/3 of the arm between the lower edge of the shoulder bone and the armpit. Approximately three finger widths below the shoulder bone is the safe area.

- b. Buttocks-the upper-outer quadrant of either buttock.

**NOTE:** To identify the injection site, draw an imaginary horizontal line across the buttocks from hip bone to hip bone. Then divide each buttock in half with an imaginary vertical line. (See Figure 3-7.)

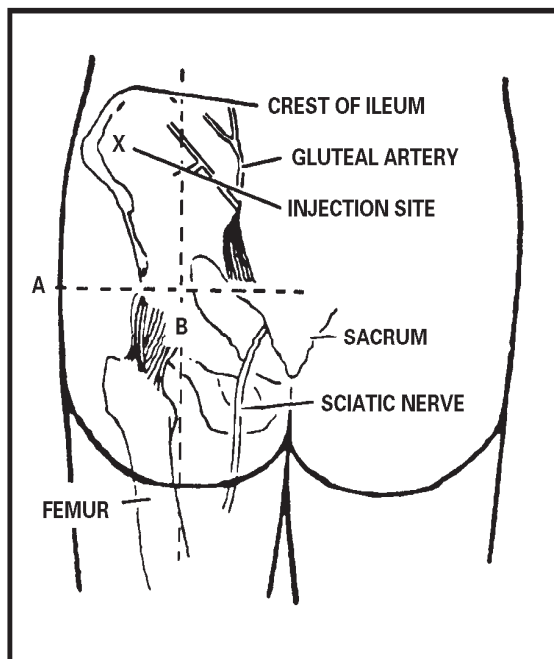

Figure 3-7. Buttock in half

**WARNING:** Do not give the injection in an area outside the upper-outer quadrant. The needle may do irreparable damage to the sciatic nerve or pierce the gluteal artery and cause significant bleeding.

c. Outer thigh-the area between a hand's width above the knee and a hand's width below the groin.

6. Position the patient.

a. Upper arm-standing or sitting with the area completely exposed, muscles relaxed, and the arm at the side.

b. Buttocks-lying face down or leaning forward and supported by a stable object with the weight shifted to the leg that will not be injected. The area is completely exposed.

*NOTE:* If the patient is lying in a prone position (face down), place the toes together with the heels apart. This will relax the muscles of the buttocks.

c. Outer thigh-lying face up or seated with the area completely exposed.

7. Clean the injection site.

a. Open the antiseptic pad package.

b. Begin at the injection site and move the pad outward in a circular motion to a circumference of about 2 inches (5cm).

c. Allow the skin to dry completely before administering injection.

*NOTE:* This will avoid a stinging sensation from introducing alcohol into subcutaneous tissue.

8. Pull the needle cover straight off without bending or touching the needle.

**WARNING:** Do not violate aseptic technique.

9. Prepare the skin for the injection.



a. Form a fold of skin at the injection site by pinching the skin gently between the thumb and the index finger of the non-dominant hand.

b. Do not touch the injection site.

10. Insert the needle.

a. With the dominant hand, position the needle, bevel up, at a 90 degree angle to, and about 1/2 inch from, the skin surface.

b. Plunge the needle firmly and quickly, in one motion straight into the muscle.

11. Release the hold on the skin.

12. Administer the medication.

a. Aspirate by pulling back slightly on the plunger of the syringe.

**WARNING:** Do not aspirate for blood when giving insulin or heparin. It is not necessary with insulin and may cause a hematoma with heparin.

(1) If blood appears, stop the procedure. Go to step 4 and begin the procedure again. Use a new needle, syringe, and medication, and select a different injection site.

**CAUTION:** If blood appears in the syringe, the needle is in a blood vessel. If this occurs, stop the injection, withdraw the needle, prepare another injection with new equipment, and inject another site.

(2) If no blood appears, continue the procedure.

b. Using a slow continuous movement, completely depress the plunger, injecting the medication.

**NOTE:** Rapid pressure may cause a burning pain.

c. After injection, withdraw the needle at the same angle at which it was inserted.

**NOTE:** Gently, but quickly.

d. Discard syringe with needle attached in sharps container IAW local facilities' standing operating procedure (SOP).

e. Place an antiseptic pad (or 2 x 2 gauze pad) over the injection site and gently massage the site (unless contraindicated, as with heparin and insulin), to distribute the medication and facilitate absorption.

f. Remove the alcohol pad and check the injection site for bleeding and/or bruising.

**NOTE:** Place bandage over site if small amount of bleeding is noted.

13. Monitor patient for any adverse reactions.

a. Observe the patient for anaphylactic shock symptoms IAW local SOP. (See task 081-833-0031.)

b. Notify medical officer of any adverse reactions immediately.

14. Discard all equipment IAW standard precautions, SOP, and infection control guidelines.

15. Document the procedure on the appropriate form.

a. Patient.

b. Medication.

c. Dose.

- d. Route.
- e. Time.
- f. Patient's tolerance of procedure.
- g. Any adverse reactions to procedure/medication.

**Evaluation Preparation:**

Setup: For training and evaluation, use another Soldier to be the simulated patient. For the IM injection, use 0.9% normal saline.

Brief Soldier: Tell the Soldier the simulated patient requires an IM injection to be given.

<b>Performance Measures</b>	GO	NO GO
1 Verified the required injection(s) with the medical officer's order.	_____	_____
2 Identified the patient by asking the patient's name and checking the identification tag or band.	_____	_____
3 Asked the patient if he/she has any allergies or has experienced a drug reaction.	_____	_____
4 Verified that the appropriate needle, syringe, and medication are being used.	_____	_____
5 Selected and exposed the injection site.	_____	_____
6 Positioned the patient.	_____	_____
7 Cleaned the injection site.	_____	_____
8 Pulled the needle cover straight off without bending or touching the needle.	_____	_____
9 Prepared the skin for injection.	_____	_____
10 Inserted the needle.	_____	_____
11 Released the hold on the skin.	_____	_____
12 Administered the medication.	_____	_____
13 Monitored patient for any adverse reactions.	_____	_____
14 Disposed all equipment IAW standard precautions, SOP, and infection control guidelines.	_____	_____
15 Documented the procedure on the appropriate form.	_____	_____

**Evaluation Guidance:** Score each Soldier according to the performance measures. Unless otherwise stated in the task summary, the Soldier must pass all performance measures to be scored GO. If the Soldier fails any steps, show what was done wrong and how to do it correctly.

**References**

**Required**  
None

**Related**  
None

## Administer an Intradermal Injection

**081-833-0303**

**Conditions:** You have a patient that requires an intradermal injection. You will need syringe(s) with the prepared medication(s), antiseptic pads, alcohol sponge swabs, sterile gauze, adhesive tape, and the patient's record. You have performed a patient care handwash and have verified the medical officer's order. You are not in a CBRN environment.

**Standards:** Administer the injection in accordance with (IAW) the medical officer's order without violating aseptic technique or causing injury to the patient.

### Performance Steps

1. Verify the required injection(s) with the medical officer's order.

**WARNING:** 1. If there is a known allergy, do not administer the injection. Consult your supervisor. 2. Determine if a female patient is pregnant because of possible side effects of certain immunizing agents on the unborn child. If there is a question, do not administer the injection without written authorization.

2. Identify the patient by asking the patient's name and checking the identification tag or band.

3. Ask the patient if he/she has any allergies or has experienced a drug reaction.

**WARNING:** Have an emergency tray available for the immediate treatment of serious reactions. Include a constricting band and a syringe containing a 1:1000 solution of epinephrine.

4. Verify that the appropriate needle, syringe, and medication are being used. (See task 081-833-0088.)

5. Select and expose the injection site.

- a. Inner forearm.
- b. Back of the upper arm.
- c. On the back below the shoulder blades.

6. Position the patient.

- a. Inner forearm- standing, sitting, or lying. Palm up, with the arm supported and relaxed.
- b. Upper arm- standing or sitting with the area completely exposed, muscles relaxed, and the arm at the side.
- c. Back- seated, leaning forward and supported on a stable object, or lying face down.

7. Clean the injection site.

- a. Open the antiseptic pad package.
- b. Begin at the injection site and move the pad outward in a circular motion to a circumference of about 2 inches (5cm).
- c. Allow the skin to dry completely before administering injection.

**NOTE:** This will avoid a stinging sensation from introducing alcohol into subcutaneous tissue.

8. Pull the needle cover straight off without bending or touching the needle.

**WARNING:** Do not violate aseptic technique.

9. Prepare the skin for the injection.

**CAUTION:** Do not retract or move the skin laterally.

a. Using the thumb of the non-dominant hand, apply downward pressure directly below and outside the prepared injection site.

b. Hold the skin taut until the needle has been inserted.

10. Insert the needle.

a. With the dominant hand, position the needle, bevel up, at a 15 to 20 degree angle to the skin surface.

b. Insert it just under the skin until the bevel is covered. Do not move the skin.

11. Release the hold on the skin.

*NOTE:* To help avoid injecting the drug into compressed tissue and irritating the nerve fibers.

12. Administer the medication.

*NOTE:* Do not aspirate.

a. Push the plunger slowly forward until all medication has been injected and a wheal appears at the site of the injection.

(1) If a wheal does not appear, go to step 4 and begin the procedure again. Use a new needle, syringe, and medication and select a different injection site.

(2) If a wheal appears, continue the procedure.

b. Quickly withdraw the needle at the same angle at which it was inserted.

c. Without applying pressure, cover the injection site with dry sterile gauze.

d. Instruct the patient not to scratch, rub, or wash the injection site.

e. If appropriate, instruct the patient when and where to have the test read IAW local standing operating procedure (SOP).

f. Remove the dry sterile gauze from the injection site and check for bleeding.

13. Monitor the patient for any adverse reactions.

a. Observe the patient for anaphylactic shock symptoms IAW local SOP. (See task 081-833-0031.)

b. Notify medical officer of any adverse reactions immediately.

14. Discard all equipment IAW standard precautions, SOP, and infection control guidelines.

15. Document the procedure on the appropriate form.

a. Patient.

b. Medication.

c. Dose.

d. Route.

e. Time.

f. Patient's tolerance of procedure.

g. Any adverse reaction to procedure/medication.

**Evaluation Preparation:**

Setup: For training and evaluation, use another Soldier to be the simulated patient. For the ID injection, use 0.9% normal saline.

Brief Soldier: Tell the Soldier the simulated patient requires an ID injection to be given.

<b>Performance Measures</b>	<b>GO</b>	<b>NO GO</b>
1 Verified the required injection(s) with the medical officer's order.	_____	_____
2 Identified the patient by asking the patient's name and checking the identification tag or band.	_____	_____
3 Asked the patient if he/she has any allergies or has experienced a drug reaction.	_____	_____
4 Verified that the appropriate needle, syringe, and medication are being used.	_____	_____
5 Selected and exposed the injection site.	_____	_____
6 Positioned the patient.	_____	_____
7 Cleaned the injection site.	_____	_____
8 Pulled the needle cover straight off without bending or touching the needle.	_____	_____
9 Prepared the skin for injection.	_____	_____
10 Inserted the needle.	_____	_____
11 Released the hold on the skin.	_____	_____
12 Administered the medication.	_____	_____
13 Monitored the patient for any adverse reactions.	_____	_____
14 Discarded all equipment IAW standard precautions, SOP, and infection control guidelines.	_____	_____
15 Documented the procedure on the appropriate form.	_____	_____

**Evaluation Guidance:** Score each Soldier according to the performance measures. Unless otherwise stated in the task summary, the Soldier must pass all performance measures to be scored GO. If the Soldier fails any steps, show what was done wrong and how to do it correctly.

**References**

**Required**  
None

**Related**  
None

## Administer Common Medications

081-833-0304

**Conditions:** You have a patient requiring medication to be administered. You have the patient's medical records and a medical officer's order to give the medication. You will need prescribed medication, calibrated disposable medicine cups, tray, non-sterile gloves, sterile gauze, sterile normal saline, tongue depressor, sterile medication chamber T-piece, corrugated tubing, non-rebreather mask, airflow tubing, a source of compressed air or oxygen with flowmeter, nebulizer kit, metered dose inhaler mouthpiece, DA Form 4678 (Therapeutic Documentation Care Plan), Medications, DA Form 3949 (Controlled Substances Record), and a pen. A patient care hand wash has been performed. You are not in a CBRN environment.

**Standards:** Administer medications with zero errors in accordance with (IAW) the medical officer's orders and without causing harm/injury to the patient.

### Performance Steps

1. Check the DA Form 4678 against the medical officer's orders.

*NOTE:* Always use body substance isolation (BSI) precautions when administering common medications, at a minimum gloves and eye protection.

- a. Right medication.
- b. Right dose of medication.
- c. Right patient.
- d. Right route of administration.
- e. Right time to be administered.

2. Select the medication.

*NOTE:* Take the DA Form 4678 with you when giving medications. This provides a means for a final check before giving the medication(s). This also allows you to document the administration before leaving the patient and prevents forgetting to document or documenting on the wrong patient's DA Form 4678.

a. Check the medication label three times to ensure that the correct medication is being prepared for administration.

- (1) First time-when removing the container from the storage shelf.
- (2) Second time-when preparing the medication dose.
- (3) Third time-when returning the container to the storage shelf.

- b. Check the expiration date of the medication.
- c. Handle only one medication at a time.

*NOTE:* If unfamiliar with a medication, look it up to determine contraindications, precautions, and side effects before preparing it for administration.

3. Confirm patient identity.
  - a. Ask patient for their full name.
  - b. Check patient's identification band.
  - c. Have patient state their date of birth.

## 4. Ask patient about any allergies.

**NOTE:** Checking for allergies is essential to prevent patient injury. Allergies include foods and latex.

- a. Check patient's clinical records for allergies.
- b. Check patient's wrist for allergy bands or bracelet(s).

## 5. Explain the procedure to the patient.

## 6. Administer by mouth/orally (po) medications.

- a. Calculate the amount of medication required to equal the prescribed dose.
- b. Prepare the prescribed dose of medication.

(1) Tablets or capsules. Transfer the prescribed dose of tablets or capsules to the medicine cup.

## (2) Liquids.

- (a) Pour the prescribed dose of liquid medication into the medicine cup.
- (b) Small amounts of liquid medication should be drawn up in a syringe.

## (3) Powders.

(a) Pour the correct dose of powdered or granulated medication into the medicine cup.

(b) Pour the required amount of water or juice into a paper cup.

(4) Unit-dose. Keep all unit-dose medications in their individual packages until you are with the patient.

**NOTE:** Open the packages in front of the patient and pour the medications into a clear medication cup or into the patient's hand (if the patient requests this and is reliable).

c. Sign for controlled drugs on DA Form 3949, IAW local standing operating procedure (SOP).

- d. Correctly identify the patient.
- e. Locate the correct medication.
- f. Give the medication to the patient at the prescribed time.

**CAUTION:** Do not leave a medication tray, package, or cup within the reach of patient. If you must leave the room, take the medication with you.

(1) Tablets, capsules, or liquids. Observe the patient swallow the tablets, capsules, or liquids.

## (2) Buccal and sublingual administration.

**CAUTION:** Do not give liquids to a patient receiving buccal medication because some buccal tablets can take up to 1 hour to be absorbed.

- (a) Place the tablet in the buccal pouch (between the cheek and gum).

**NOTE:** Alternate sides of the mouth for repeat doses to prevent continuous irritation of the same site.

**WARNING:** If the patient smokes, tell them not to do so before the drug has dissolved because nicotine's vasoconstrictive effects slows absorption.

(b) Sublingual administration (place the tablet under the patient's tongue).

*NOTE:* Instruct the patient to keep the medication in place until it dissolves. Caution them against chewing the tablet or touching it with their tongue to prevent accidental swallowing. Inform the angina patient to wet the nitroglycerin tablet with saliva and to keep it under their tongue until it has been fully absorbed.

(c) Translingual administration. Tell the patient to hold the medication canister vertically, with the valve head at the top and spray the orifice as close to their mouth as possible.

(d) Instruct them to spray the dose onto their tongue by pressing the button firmly.

**WARNING:** Remind the patient using a translingual aerosol form that they should not inhale the spray but should release it under tongue. Also tell them to wait 10 seconds or so before swallowing.

#### 7. Administer aerosolized and powdered respiratory medications.

*NOTE:* Avoid treatments immediately before and after meals. This helps decrease the chance of vomiting or appetite suppression, especially with medications that cause the patient to cough or expectorate or those that are taken in conjunction with percussion/bronchial drainage.

a. Prepare to administer inhalation medication.

(1) Review the medical officer's order.

(a) Determine the drug schedule and the number of prescribed inhalations.

(b) Compare the medication administration record with the medical officer's order and medication label.

(2) Assess the patient's medical history to identify contraindications/allergies to drug administration.

(3) Identify the patient and provide privacy.

(4) Explain the procedure to the patient.

(5) Wash your hands and follow standard precautions.

(6) Arrange equipment.

(7) Assess the patient's respiratory status and report unexpected findings to the medical officer.

b. Assess the patient's knowledge and ability to handle the required equipment.

(1) Knowledge of disease and drug therapy.

(2) Willingness to learn.

(3) Ability to demonstrate use of the required equipment.

(a) Handicap such as blindness.

(b) Ability to form an airtight seal with mouth.

(c) Appropriate strength.

c. Administer the medication.



- (1) Liquid metered dose inhaler.
  - (a) Ensure the patient is in a sitting or standing position.
  - (b) Insert the medication canister stem down into the longer part of the metered dose dispenser.
  - (c) Hold the canister upright and shake to mix the medication and propellant before each use.
  - (d) Remove the mouthpiece cover and have the patient hold the mouthpiece 2 inches from his mouth.
  - (e) Have the patient take a deep breath through pursed lips and then exhale to promote greater inspiratory volume.
  - (f) Instruct the patient to inhale slowly, through the mouth, as the canister is depressed. Have the patient inhale for 3 to 5 seconds.
  - (g) Instruct the patient to hold his breath for 10 seconds and then exhale slowly through pursed lips.
- (2) Dry powder inhaler.
  - (a) Have the patient hyperextend the neck.
  - (b) Ask the patient to place his lips around the mouth of the dispenser.
  - (c) Ensure there is an airtight seal.
  - (d) Have the patient depress the canister while taking a quick deep breath.
  - (e) Instruct the patient to hold his breath for 10 seconds.
  - (f) Have the patient exhale slowly through pursed lips.
  - (g) Instruct the patient to wait 2 minutes between puffs, if more than one puff is ordered.
- (3) Inhaler with a spacing device.
  - (a) Shake the inhaler.
  - (b) Remove the mouthpiece cover.
  - (c) Insert the metered dose inhaler into the spacer device.
  - (d) Have the patient place in mouth and close lips.
  - (e) Instruct the patient to breathe normally through the spacer device mouthpiece.
  - (f) Have the patient depress the canister one time.
  - (g) Ask the patient to breathe in slowly for 5 seconds.
  - (h) Have the patient hold his breath for 5 to 10 seconds and then slowly exhale.
  - (i) Wait the appropriate interval and repeat the procedure for the prescribed number of puffs.
- (4) Small volume nebulizer.
  - (a) Assemble equipment according to manufacturer's instructions.
  - (b) Add the prescribed medication and diluent to the nebulizer.

- (c) Keep the nebulizer vertical while connecting it to a T-piece side arm.
- (d) Attach corrugated tubing to one end of the T-piece.
- (e) Attach the mouthpiece to the other end of the T-piece.
- (f) Attach the airflow tubing to the nebulizer.
- (g) Attach the other end of the airflow tubing to the air or oxygen source.
- (h) Have the patient hold the mouthpiece between the lips using gentle pressure.
- (i) Turn the nebulizer on and set the driving air or oxygen to 8 L/min.
- (j) Ask the patient to take a slow deep breath, pause, and exhale passively.
- (k) Observe to determine if a mist forms. If a mist does not form, the nebulizer is not operating correctly.
  - (l) Monitor for tachycardia during medication administration.
  - (m) Tap the nebulizer cup periodically to prevent obstruction.
  - (n) Turn off the compressor or oxygen when administration is complete.
  - (o) Encourage the patient to rinse his mouth after treatment is complete, especially if steroids were used.
  - (p) Reset oxygen to the prescribed rate if ordered.
- d. Evaluate the patient's response to treatment and report unexpected outcomes to the charge nurse or medical officer.
  - (1) Respiratory rate.
  - (2) Lung sounds.
- 8. Clean and store all equipment.
- 9. Record the administration of all medications on the appropriate medical forms.
  - a. Initial the DA Form 4678.
  - b. Annotate the nursing notes when administering controlled drugs, nonscheduled (PRN) medications, and other medications as required by local policy.
    - (1) Name of the medication.
    - (2) Time the medication was administered.
    - (3) Reason for the medication.
- 10. Record the omission of a medication on the appropriate medical forms whenever a scheduled medication is not administered.
  - a. Annotate DA Form 4678 by placing a circle in the initial block.
  - b. Annotate the nursing notes.
    - (1) Name of the medication.
    - (2) Time it should have been administered.
    - (3) Reason it was not administered.
    - (4) Follow-up action taken.

**Evaluation Preparation:**

Setup: For training and evaluation, use another Soldier to be the simulated patient.

Brief Soldier: Tell the Soldier the simulated patient requires medication to be given. Have the testing Soldier verbalize the steps for each type of medication to be delivered.

<b>Performance Measures</b>	GO	NO GO
1 Checked the DA Form 4678 against the medical officer's orders.	_____	_____
2 Selected the medication.	_____	_____
3 Confirmed patient identity.	_____	_____
4 Asked patient about any allergies.	_____	_____
5 Explained the procedure to the patient.	_____	_____
6 Administered by mouth/oral (po) medications.	_____	_____
7 Administered aerosolized and powdered respiratory medications.	_____	_____
8 Cleaned and stored all equipment.	_____	_____
9 Recorded the administration of all medications on the appropriate medical forms.	_____	_____
10 Recorded the omission of a medication on the appropriate medical forms whenever a scheduled medication was not administered.	_____	_____

**Evaluation Guidance:** Score each Soldier according to the performance measures. Unless otherwise stated in the task summary, the Soldier must pass all performance measures to be scored GO. If the Soldier fails any steps, show what was done wrong and how to do it correctly.

**References**

**Required**  
DA Form 3949  
DA Form 4678

**Related**  
None

## Administer a Subcutaneous Injection

081-833-0302

**Conditions:** You have a patient that requires a subcutaneous injection. You will need syringe(s) with the prepared medication(s), antiseptic pads, alcohol sponge swabs, sterile gauze, adhesive tape, and the patient's record. You have performed a patient care handwash and have verified the medical officer's order. You are not in a CBRN environment.

**Standards:** Administer the injection in accordance with (IAW) the medical officer's order without violating aseptic technique or causing injury to the patient.

### Performance Steps

1. Verify the required injection(s) with the medical officer's order.

**WARNINGS:** 1. If there is a known allergy, do not administer the injection. Consult your supervisor. 2. Determine if a female patient is pregnant because of possible side effects of certain immunizing agents on the unborn child. If there is a question, do not administer the injection without written authorization.

2. Identify the patient by asking the patient's name and checking the identification tag or band.

3. Ask the patient if he/she has any allergies or has experienced a drug reaction.

**WARNING:** Have an emergency tray available for the immediate treatment of serious reactions. Include a constricting band and a syringe containing a 1:1000 solution of epinephrine.

4. Verify that the appropriate needle, syringe, and medication are being used. (See task 081-833-0088.)

5. Select and expose the injection site.

**NOTE:** The preferred injection sites for insulin are the arms, abdomen, thighs, and buttocks. The preferred injection site for heparin is the lower abdominal fat pad, just below the umbilicus.

- a. Lateral upper arm.
- b. Anterior thigh.
- c. Fat pads on the abdomen.
- d. Buttocks.

6. Position the patient.

a. Upper arm-standing or sitting with the area completely exposed, muscles relaxed, and the arm at the side.

b. Outer thigh- lying face up or seated, with the area completely exposed.

c. Abdomen- lying face up, with the area completely exposed.

d. Buttocks- lying face down or leaning forward and supported by a stable object with the weight shifted to the leg that will not be injected. The area is completely exposed.

7. Clean the injection site.

a. Open the antiseptic pads package.

b. Begin at the injection site and move the pad outward in a circular motion to a circumference of about 2 inches (5cm).

- c. Allow the skin to dry completely before administering injection.

*NOTE:* This will avoid a stinging sensation from introducing alcohol into subcutaneous tissue.

- 8. Pull the needle cover straight off without bending or touching the needle.

**WARNING:** Do not violate aseptic technique.

- 9. Prepare the skin for the injection.
  - a. Form a fold of skin at the injection site by pinching the skin gently between the thumb and the index finger of the non-dominant hand.
  - b. Do not touch the injection site.

- 10. Insert the needle.
  - a. With the dominant hand, position the needle, bevel up, at a 45 degree angle to the skin surface.
  - b. Insert the needle firmly and quickly in one motion into the fatty tissue below the skin.

- 11. Release the hold on the skin.

*NOTE:* To help avoid injecting the drug into compressed tissue and irritating the nerve fibers.

- 12. Administer the medication.
  - a. Aspirate by pulling back slightly on the plunger of the syringe.

**WARNING:** Do not aspirate for blood return when giving insulin or heparin. It is not necessary with insulin and may cause a hematoma with heparin.

(1) If blood appears, stop the procedure. Go to step 4 and begin the procedure again. Use a new needle, syringe, and medication, and select a different injection site.

**CAUTION:** If blood appears in the syringe on aspiration, the needle is in a blood vessel. If this occurs, stop the injection. Withdraw the needle, prepare another injection with new equipment, and inject another site.

- (2) If no blood appears, continue the procedure.
  - b. Using a slow continuous movement, completely depress the plunger, injecting the medication.

*NOTE:* Rapid pressure may cause a burning pain.

- c. After injection, withdraw the needle at the same angle at which it was inserted.

*NOTE:* Gently but quickly.

d. Discard syringe with needle attached in sharps container IAW local facilities' standing operating procedure (SOP) and infection control guidelines.

e. Place an antiseptic pad (or 2 x 2 gauze pad) over the injection site and gently massage the site (unless contraindicated, as with heparin and insulin), to distribute the medication and facilitate absorption.

- f. Remove the alcohol pad and check the injection site for bleeding and/or bruising.

*NOTE:* Place bandage over site if small amount of bleeding is noted.

- 13. Monitor patient for any adverse reactions.
  - a. Observe the patient for anaphylactic shock symptoms IAW local SOP. (See task 081-833-0031.)

- b. Notify medical officer of any adverse reactions immediately.
- 14. Discard all equipment IAW standard precautions, SOP, and infection control guidelines.
- 15. Document the procedure on the appropriate form.
  - a. Patient.
  - b. Medication.
  - c. Dose.
  - d. Route.
  - e. Time.
  - f. Patient's tolerance of procedure.
  - g. Any adverse reactions to procedure/medication.

**Evaluation Preparation:**

Setup: For training and evaluation, use another Soldier to be the simulated patient. For the SC injection, use 0.9% normal saline.

Brief Soldier: Tell the Soldier the simulated patient requires a SC injection to be given.

<b>Performance Measures</b>	<b>GO</b>	<b>NO GO</b>
1 Verified the required injection(s) with the medical officer's order.	_____	_____
2 Identified the patient by asking the patient's name and checking the identification tag or band.	_____	_____
3 Asked the patient if he/she has any allergies or has experienced a drug reaction.	_____	_____
4 Verified that the appropriate needle, syringe, and medication are being used.	_____	_____
5 Selected and exposed the injection site.	_____	_____
6 Positioned the patient.	_____	_____
7 Cleaned the injection site.	_____	_____
8 Pulled the needle cover straight off without bending or touching the needle.	_____	_____
9 Prepared the skin for the injection.	_____	_____
10 Inserted the needle.	_____	_____
11 Released the hold on the skin.	_____	_____
12 Administered the medication.	_____	_____
13 Monitored patient for any adverse reactions.	_____	_____
14 Discarded all equipment IAW standard precautions, SOP, and infection control guidelines.	_____	_____
15 Documented the procedure on the appropriate form.	_____	_____

**Evaluation Guidance:** Score each Soldier according to the performance measures. Unless otherwise stated in the task summary, the Soldier must pass all performance measures to be scored GO. If the Soldier fails any steps, show what was done wrong and how to do it correctly.

**References****Required**

None

**Related**

None

## Administer Inhalation Medications

081-833-0022

**WARNING:** The use of inhalers may be contraindicated in patients who cannot form an airtight seal around the device and in patients who lack the coordination or clear vision to assemble a turbo inhaler. Bronchodilators are contraindicated if the patient has tachycardia or history of cardiac arrhythmias associated with tachycardia.

**Conditions:** You have a patient requiring inhalation medications. You will need a DA Form 4678 Therapeutic Documentation Care Plan (Medications) record, SF 510 Nursing Notes, the patient's clinical records, a metered-dose inhaler, turbo inhaler or nasal inhaler, prescribed medications, disposable gloves, normal saline solution (or another appropriate solution) for gargling, pen, spacer, and an emesis basin (optional). You have performed a patient care hand wash and are not in a CBRN environment.

**Standards:** Administer inhalation medications without causing harm to the patient.

**NOTE:** Hand held inhalers use air under pressure to produce a mist containing tiny droplets of medication. Drugs delivered in this form (such as mucolytics and bronchodilators) can travel deep into the lungs. Because these devices deliver topical medications to the respiratory tract, they produce local and systemic effects. The mucosal lining of the respiratory tract absorbs the inhalant almost immediately.

### Performance Steps

1. Ask the patient about allergies.
  - a. Check patient's clinical record for listing of allergies.
  - b. Check patient's wrist band for allergies.
2. Explain the procedure to the patient.
  - a. If more than one inhalation is ordered, advise the patient that there will be at least 2 minutes before repeating the procedure.
  - b. If the patient has a steroid inhaler, instruct them that you will use the bronchodilator first and then wait 5 minutes before using the steroid.

**NOTE:** This allows the bronchodilator to open the air passages for maximum effectiveness.

3. Provide privacy for the patient.
4. Put on disposable gloves.
5. Administer inhaler.
  - a. Metered-dose inhaler.
    - (1) Shake the inhaler bottle to mix the medication and aerosol propellant.
    - (2) Remove the mouthpiece and cap.

**NOTE:** Some metered-dose inhalers have a spacer built into the inhaler. Pull the spacer away from the section holding the medication canister until it clicks into place.

(3) Insert the metal stem on the bottle into the small hole on the flattened portion of the mouthpiece, then turn the bottle upside down.

(4) Have the patient exhale, and then place the mouthpiece in their mouth and instruct them to close their lips around it.



(5) Firmly push the bottle down against the mouthpiece, ask the patient to inhale slowly and to continue inhaling until their lungs feel full (3 to 5 seconds).

*NOTE:* This actions draws the medication into their lungs.

(6) Compress the bottle against the mouthpiece only once.

(7) Remove the mouthpiece from the patient's mouth, and tell them to hold their breath for several seconds to allow the medication to reach the alveoli (5 to 10 seconds).

(8) Instruct the patient to exhale slowly through pursed lips to keep the distal bronchioles open, allowing increased absorption and diffusion of the drug and better gas exchange.

*NOTE:* The lungs retain only about 10% of the inhalant; most of the remainder is exhaled, but substantial amounts may remain in the oropharynx.

b. Turbo inhaler.

(1) Hold the mouthpiece in non-dominant hand and with dominant hand slide the sleeve away from the mouthpiece as far as possible.

(2) Unscrew the tip of the mouthpiece by turning it counterclockwise.

(3) Firmly press the colored portion of the medication capsule into the propeller step of the mouthpiece.

(4) Screw the inhaler together again securely.

(5) Holding the inhaler with the mouthpiece at the bottom, slide the sleeve all the way down and then up again to puncture the capsule and release the medication.

*NOTE:* Do this only once.

(6) Have the patient exhale and tilt their head back.

(7) Tell them to put the mouthpiece in their mouth, close their lips around it and inhale once-quickly and deeply through the mouthpiece.

(8) Tell the patient to hold their breath for several seconds to allow the medication to reach the alveoli (5 to 10 seconds).

*NOTE:* Instruct them not to exhale through the mouthpiece.

(9) Remove the inhaler from the patient's mouth and tell them to exhale as much air as possible.

(10) Repeat the procedure until all of the medication in the device is inhaled.

c. Nasal inhaler.

(1) Have the patient blow their nose to clear their nostrils.

(2) Shake the medication cartridge and then insert it into the adapter.

*NOTE:* Before inserting a refill cartridge, remove the protective cap from the stem.

(3) Remove the protective cap from the adapter tip. Hold the inhaler with your index finger on top of the cartridge and your thumb under the nasal adapter (with your dominant hand). The adapter tip should be pointing towards the patient.

(4) Have the patient tilt their head back.

(5) Tell the patient to place the adapter tip into one nostril while occluding the other nostril with their finger.

(6) Instruct the patient to inhale gently as he presses the adapter and the cartridge together firmly to release a measured dose of medication.

- (7) Tell the patient to remove the inhaler from their nostril and to hold their breath for a few seconds (5 to 10 seconds).
- (8) Have the patient exhale through their mouth.
- (9) Shake the inhaler and have the patient repeat the procedure with the other nostril.
- 6. Have patient gargle with normal saline solution to remove medication from their mouth and throat.
- 7. Provide emesis basin if needed.
- 8. Discard inhaler.
  - a. Turbo inhaler.
    - (1) Discard the empty medication capsule IAW local facility SOP.
    - (2) Put the inhaler in its can.
    - (3) Secure the lid.

**CAUTION:** When using a turbo or nasal inhaler, make sure the pressurized cartridge is not punctured or incinerated. Store the medication cartridge below 120° F (48.9° C).

- b. Nasal - Remove the medication cartridge and discard IAW local facility SOP.

**NOTE:** Let the adapter dry thoroughly before reinserting the cartridge.

- 9. Empty emesis basin and discard IAW local facility SOP.
- 10. Clean equipment.
  - a. Metered-dose inhaler-rinse the mouthpiece thoroughly with warm water to prevent accumulation of residue.
  - b. Turbo inhaler-rinse the inhaler with warm water at least once per week.
  - c. Nasal inhaler-wash the nasal adapter in lukewarm water.
- 11. Remove gloves and discard IAW local facility policies and infection control guidelines.
- 12. Perform a patient care hand wash.
- 13. Document procedure on appropriate form IAW local SOP.
  - a. How well the patient tolerated the procedure.
  - b. Time and date of the procedure.
  - c. Medication administered.
  - d. Patient's response to medication administered.

**Evaluation Preparation:**

Setup: For training and evaluation, have another Soldier act as the patient and have the evaluated Soldier verbalize the actual part of the inhalation procedure.

<b>Performance Measures</b>	<b>GO</b>	<b>NO GO</b>
1 Asked patient about allergies.	_____	_____
2 Explained procedure to patient.	_____	_____
3 Provided privacy for patient.	_____	_____

<b>Performance Measures</b>	GO	NO GO
4 Put on disposable gloves.	_____	_____
5 Administered inhalers.	_____	_____
6 Had patient gargle with normal saline solution.	_____	_____
7 Provided emesis basin if needed	_____	_____
8 Discarded inhaler.	_____	_____
9 Emptied emesis basin and discarded IAW local facility SOP.	_____	_____
10 Cleaned equipment.	_____	_____
11 Removed and disposed of gloves.	_____	_____
12 Performed a patient care handwash.	_____	_____
13 Documented procedure on appropriate form IAW local SOP.	_____	_____

**Evaluation Guidance:** Score each Soldier according to the performance measures. Unless otherwise stated in the task summary, the Soldier must pass all performance measures to be scored GO. If the Soldier fails any step, show what was done wrong and how to do it correctly.

**References**

**Required**  
 DA Form 4678  
 SF 510

**Related**  
 None

**Subject Area 11: Force Health Protection**  
**Implement Suicide Prevention Measures**  
**081-831-9018**

**Conditions:** You have a patient demonstrating possible suicidal behavior. You are not in a CBRN environment.

**Standards:** Implement suicide prevention measures.

**Performance Steps**

1. Gather information on risk factors about the patient, if not already known and time permits.
  - a. Historical risk factors-divorce, recent deployments, history of depression.
  - b. Talking about death or hinting at a suicide.
  - c. Giving away important possessions.
  - d. Obsession with death.
  - e. Significant change in performance or uncharacteristic behaviors.
  - f. Ask directly-Are you thinking of suicide?
2. Minimize possibility of self-harm.
  - a. Remove all potential means of self-harm (firearms, pills, knives).
  - b. Take all suicidal threats seriously.
  - c. Convey concern.
  - d. Get professional help-go with the Soldier or send with an escort.

**Evaluation Preparation:**

Have a fellow Soldier role play a simulated suicidal individual. Provide the role player with an example to follow. A private area should be made available (simulated).

**Performance Measures**

GO                      NO GO

- |   |  |       |       |
|---|--|-------|-------|
| 1 | Gathered information on suicidal risk factors. | _____ | _____ |
| 2 | Minimized possibility of self-harm.            | _____ | _____ |

**Evaluation Guidance:** Score each Soldier according to the performance measures. Unless otherwise stated in the task summary, the Soldier must pass all performance measures to be scored GO. If the Soldier fails any steps, show what was done wrong and how to do it correctly.

**References**

**Required**  
None

**Related**  
None

**Treat a Casualty for a Heat Injury**  
**081-831-0038**

**CAUTION:** All body fluids should be considered potentially infectious. Always observe body substance isolation (BSI) precautions by wearing gloves and eye protection as a minimal standard of protection.

**Conditions:** A casualty is suffering from a heat injury. All other more serious injuries have been assessed and treated. You will need water, a thermometer, intravenous (IV) administration set, ringer's lactate or sodium chloride, ice sheets, if available, stethoscope, sphygmomanometer, and a DD Form 1380 US Field Medical Card (FMC). You are not in a CBRN environment

**Standards:** Provide the correct treatment for the heat injury without causing further injury to the casualty.

**Performance Steps**

1. Identify the type of heat injury based upon the following characteristic signs and symptoms:
  - a. Heat cramps-muscle cramps of the arms, legs, and/or abdomen.
  - b. Heat exhaustion.
    - (1) Often-
      - (a) Profuse sweating and pale (or gray), moist, cool skin.
      - (b) Headache.
      - (c) Weakness.
      - (d) Dizziness.
      - (e) Loss of appetite or nausea.
      - (f) Normal or slightly elevated body temperature; or as high as 104° F (rarely).
    - (2) Sometimes-
      - (a) Heat cramps.
      - (b) Nausea (with or without vomiting).
      - (c) Urge to defecate.
      - (d) Chills.
      - (e) Rapid breathing.
      - (f) Tingling sensation of the hands and feet.
      - (g) Confusion.
  - c. Heat stroke.
    - (1) Rapid onset with the core body temperature rising to above 106° F within 10 to 15 minutes.
    - (2) Hot, dry skin.
    - (3) Headache.

**NOTE:** Early in the progression of heat stroke, the skin may be moist or wet.

- (4) Dizziness.
- (5) Headache.
- (6) Nausea.
- (7) Confusion.
- (8) Weakness.
- (9) Loss of consciousness.
- (10) Possible seizures.
- (11) Pulse and respirations are weak and rapid.

*NOTE:* A key to distinguishing heat stroke from other heat disorders is the elevation of body temperature and altered mental status. Any casualty warm to the touch with an altered mental status should be suspected of having heat stroke and treated aggressively.

2. Provide the proper treatment for the heat injury.

a. Heat cramps.

- (1) Move the casualty to a cool shaded area, if possible.
- (2) Loosen the casualty's clothing unless he is in a chemical environment.
- (3) Rest the cramping muscles.
- (4) Oral rehydration with water or electrolyte solution.
- (5) Evacuate the casualty if the cramps are not relieved after treatment.

*NOTE:* Do not give salt tablets.

b. Heat exhaustion.

(1) Conscious casualty.

- (a) Move the casualty to a shaded area, if possible.
- (b) Loosen and/or remove the casualty's clothing and boots unless he is in a chemical environment.
- (c) Pour water on the casualty and fan him, if possible.
- (d) Oral rehydration unless nauseated. If nauseated, initiate IV hydration.
- (e) Place casualty in an ice sheet if available.
- (f) Elevate the casualty's legs.
- (g) Provide oxygen to the casualty, if not already done as part of the initial assessment.

(2) An unconscious casualty or one who is nauseated, unable to retain fluids, or whose symptoms have not improved after 20 minutes.

- (a) Cool the casualty as in step 2b(1).
- (b) Initiate an IV infusion of ringer's lactate or sodium chloride.
- (c) Evacuate the casualty.
- (d) Transport the casualty on his side if they are nauseated.

**CAUTION:** Heat stroke is a medical emergency. If the casualty is not cooled rapidly, the body cells, especially the brain cells, are literally cooked; irreversible damage is done to the central nervous system. The casualty must be evacuated to the nearest medical treatment facility immediately.

c. Heat stroke.

(1) Conscious casualty.

- (a) Cool the casualty with any means available, even before taking the clothes off.
- (b) Remove the casualty's outer garments and/or protective clothing.
- (c) Lay the casualty down and elevate his legs.
- (d) Immerse the casualty in cold water, or use an ice sheet if available.
- (e) Ice packs in groin, axillae and around the neck, if available.
- (f) Provide supplemental oxygen, if available.
- (g) Initiate an IV infusion of Ringer's lactate or sodium chloride.
- (h) Evacuate the casualty.

(2) Unconscious casualty or one who is vomiting or unable to retain oral fluids.

- (a) Cool the casualty as in steps 2c(1a-f) but give nothing by mouth.
- (b) Initiate an IV.
- (c) Evacuate the casualty.

3. Record the treatment given on a FMC. (See task 081-831-0033.)

**Evaluation Preparation:**

Setup: For training and evaluation, describe to the Soldier the signs and symptoms of heat cramps, heat exhaustion, or heat stroke and ask the Soldier what type of heat injury is indicated.

Brief Soldier: Ask the Soldier what should be done to treat the heat injury.

**Performance Measures**

**GO            NO GO**

- |  |       |       |
|--|-------|-------|
| 1 Identified the type of heat injury.                | _____ | _____ |
| 2 Provided the proper treatment for the heat injury. | _____ | _____ |
| 3 Recorded the treatment given on a FMC.             | _____ | _____ |

**Evaluation Guidance:** Score each Soldier according to the performance measures. Unless otherwise stated in the task summary, the Soldier must pass all performance measures to be scored GO. If the Soldier fails any steps, show what was done wrong and how to do it correctly.

**References**

**Required**  
DD Form 1380

**Related**  
None

## Treat a Casualty for Insect Bites or Stings

081-833-0072

**Conditions:** You have a casualty with insect bites or stings. You have treated all other immediate life threats. You have taken body substance isolation (BSI) precautions. You will need normal saline, mild or strong soap cleansing solution, pen, clean (aseptic) tweezers, blade, or card (hard plastic i.e. Identification card), sterile 4 x 4 gauze pads, sphygmomanometer, stethoscope, and a DD Form 1380 US Field Medical Card (FMC). You are not in a CBRN environment.

**Standards:** Treat the casualty for insect bites or stings, without causing further injury.

### Performance Steps

1. Expose the injury site.

*NOTE:* Remove clothing, rings, watches, and other constricting items that are in the area of the bite or sting to prevent circulatory impairment in the event swelling of the extremity occurs.

2. Determine the type of insect bite or sting.

- a. Gather information from the casualty, ask them if they saw what bit or stung them.

**WARNING:** Be alert for indications of casualty developing anaphylaxis such as hoarseness, a feeling of swelling or lump in the throat, wheezing and signs and symptoms of shock.

- b. If the casualty is unconscious, check for a medical alert bracelet or tag (allergy band).

*NOTE:* It is important to determine if the casualty has a history of past reactions to similar bites or stings.

3. Check the casualty for the signs and symptoms of insect bites and stings.

- a. Black widow spider.

- (1) A pinprick sensation at the bite site, becoming a dull ache within about 30 minutes.

(2) Severe painful muscle spasms, especially in the shoulders, back, chest and abdomen.

- (a) Begin in 10 to 40 minutes.

- (b) Peak in 1 to 3 hours.

- (c) Persist for 12 to 48 hours.

- (3) Rigid, board-like abdomen.

- (4) Dizziness, nausea and vomiting and respiratory distress in severe cases.

- b. Brown recluse spider.

*NOTE:* The brown recluse spider is medium sized, generally brown but can range in color from yellow to dark chocolate brown. It has a distinct groove between its chest and abdominal body parts. The characteristic marking is a brown, violin-shaped marking on the upper back.

- (1) Casualty seldom recalls being bitten, since bite is painless at first.

- (2) Several hours after the bite, it becomes bluish surrounded by a white periphery.

- (3) A red halo or "bull's-eye" pattern appears sometime later.

- (4) Within 7-10 days, the bite becomes a large ulcer.



## c. Scorpion.

*NOTE:* There are two general types of scorpions. The arizona (black) scorpion is the only deadly type in the United States.

## (1) Harmless species.

- (a) Severity of the sting depends on the amount of venom injected.
- (b) Ninety percent of all scorpion stings occur on the hands.
- (c) Scorpion stings cause a sharp pain at the injection site.
- (d) The symptoms last for 24 to 72 hours.

## (2) Deadly species.

- (a) Sharp pain at the injection site, "pins and needles" sensation.
- (b) Severe muscle contractions.
- (c) Drooling.
- (d) Poor circulation.
- (e) Hypertension.
- (f) Cardiac failure.
- (g) Incontinence.
- (h) Seizures.

## d. Bee, wasp, hornet, and yellow jacket.

*NOTE:* A wasp or yellow jacket (slender body with elongated abdomen) retains its stinger and can sting repeatedly. A honey bee (round abdomen) usually leaves its stinger in the casualty.

## (1) Mild reaction.

- (a) Pain at the sting site.
- (b) A wheal, redness, and swelling.
- (c) Itching.
- (d) Anxiety.

## (2) Severe reaction.

- (a) Generalized itching and burning.
- (b) Urticaria (hives).
- (c) Chest tightness and cough.
- (d) Swelling around the lips and tongue.
- (e) Bronchospasm and wheezing.
- (f) Dyspnea.
- (g) Abdominal cramps.
- (h) Anxiety.
- (i) Respiratory failure.
- (j) Anaphylactic shock.

e. Fire ant(s).

**NOTE:** Fire ants inject a very irritating toxin into the skin. They bite repeatedly and in a very short period of time. Fire ants are known for their aggressive nature and for their bites. A fire ant sting is itchy yet painful and very prone to infection.

- (1) Intense, fiery, burning pain.
- (2) Characteristic circular pattern of bites.

**NOTE:** Fire ants bite down into the skin, then sting downwardly as they pivot.

- (3) Extremely painful vesicles that are filled with fluid within minutes.
- (4) Cloudy, fluid-filled bubble within 2 to 4 hours.
- (5) Bubble on red base within 8 to 10 hours.
- (6) Ulceration (with scarring after healing).
- (7) Fire ant bites can also cause a large local reaction characterized by swelling, pain and redness that affects the entire extremity.
- (8) Anaphylactic shock.

**WARNING:** Lyme disease, usually transmitted by the tiny deer tick but now thought to be transmitted by the larger dog tick, can cause long-term neurological and other complications if not identified and treated early.

f. Tick.

**NOTE:** Tick bites are serious because ticks can carry tick fever, Rocky Mountain spotted fever, Lyme disease, other bacterial diseases, and may even cause anemia if the infestation is severe enough.

- (1) Itching and redness at the site.
- (2) Headache.
- (3) Moderate to high fever, which may last 2 to 3 weeks.
- (4) Pain in the joints or legs.
- (5) Swollen lymph nodes in the bitten area.

**CAUTION:** Generally, a tick must remain attached to the body for 4 to 6 hours in order to transmit infections. Early detection and proper removal may prevent transmission.

- (6) Paralysis and other central nervous system disorders are possible after several days.

g. Unknown, nonspecific insects.

- (1) Pain and swelling at the site.
- (2) Breathing difficulty.
- (3) Shock.

**WARNING:** If the casualty shows and signs and symptoms of an allergic reaction, begin transport immediately.

4. Treat the bite or sting.

a. Black widow spider, brown recluse spider, fire ant, and scorpion bites or stings.

- (1) Keep the casualty calm and reassured.

- (a) Explain to casualty what will be done.
- (b) Limit their physical activity.

*NOTE:* Keep the limb immobilized and the casualty still to prevent distribution of the poison to other parts of the body.

- (2) Remove jewelry.
- (3) Cleanse the bite site gently using normal saline and mild or strong soap solution.

*NOTE:* If necessary, irrigate the area with a large amount of sterile saline. Make sure contaminated saline flows away from the body. Never scrub the area.

- (4) Place the site below the level of the casualty's heart.
- (5) Treat the casualty for anaphylactic shock, if necessary. (See task 081-833-0003.)
- (6) Monitor vital signs.

b. Bee, wasp, hornet, and yellow jacket.

- (1) Keep the casualty calm and reassured.
  - (a) Explain to the casualty what will be done.
  - (b) Limit their physical activity and keep warm.

(2) Remove any jewelry or other constricting objects as soon as possible, ideally before any swelling begins.

- (3) Remove the stinger or venom sac.
- (4) Cleanse the site using normal saline and a mild or strong soap solution.

*NOTE:* If necessary, irrigate the area with a large amount of sterile saline. Make sure that the contaminated saline flows away from the body. Never scrub the area.

**CAUTION:** Application of a cold pack to an insect bite or sting to relieve pain and swelling should be followed in accordance with (IAW) local standard operating procedure (SOP) and medical officer's order.

- (5) Apply a cold pack to an insect bite or sting to relieve pain and swelling.
- (6) Treat the casualty for anaphylactic shock, if necessary. (See task 081-833-0003.)
- (7) Monitor vital signs.

c. Tick.

- (1) Remove all parts of the tick. Leave nothing embedded in the skin.

(a) Using tweezers, grasp the tick as close to the skin as possible. Using steady pressure, pull the tick straight out.

(b) If tweezers are not available, use an absorbent material (gauze, toweling) to protect your skin. Grasp the tick as close to the skin as possible and pull straight out using steady pressure.

(2) Wash the area around the bite gently using normal saline and a mild or strong soap solution.

- (3) Monitor vital signs.

d. Unknown, nonspecific insect.

- (1) Cleanse the site using antiseptic.
- (2) Treat the casualty for anaphylactic shock, if necessary. (See task 081-833-0003.)
- (3) Monitor the vital signs.

5. Record the treatment on a FMC.

6. Evacuate the casualty, if necessary.

*NOTE:* It is necessary to evacuate any casualty who shows signs or symptoms of respiratory distress, shock, anaphylaxis, or who does not respond to initial treatment.

**Evaluation Preparation:**

Setup: For training and evaluation, have another Soldier act as the casualty. Indicate the area of the bite or sting. To test step 3, coach the casualty on how to answer the Soldier’s questions regarding signs and symptoms such as pain. Tell the Soldier what signs and symptoms, such as respiratory distress or shock, the casualty is exhibiting.

Brief Soldier: Tell the Soldier to treat the casualty for an insect bite or sting.

<b>Performance Measures</b>	GO	NO GO
1 Exposed the injury site.	_____	_____
2 Determined the type of insect bite or sting.	_____	_____
3 Checked the casualty for the signs and symptoms of insect bites and stings.	_____	_____
4 Treated the bite or sting.	_____	_____
5 Recorded the treatment on a FMC.	_____	_____
6 Evacuated the casualty, if necessary.	_____	_____

**Evaluation Guidance:** Score each Soldier according to the performance measures. Unless otherwise stated in the task summary, the Soldier must pass all performance measures to be scored GO. If the Soldier fails any steps, show what was done wrong and how to do it correctly.

**References**

**Required**  
DD Form 1380

**Related**  
None

## Treat a Casualty for Snake Bite

**081-833-0073**

**Conditions:** You have a casualty with a snakebite. You have scanned the ground around the area, scene is safe. You have taken body substance isolation, (BSI), precautions. You will need normal saline, mild or strong soap cleansing solution, pen, and DD Form 1380 US Field Medical Card (FMC). You are not in a CBRN environment.

**Standards:** Provide treatment without causing further injury to the casualty.

### Performance Steps

1. Expose the injury site.

**WARNING:** Each person reacts differently to a snakebite. You should consider the bite from any known poisonous snake or any unidentified snake, to be an emergency.

**CAUTION:** If the bite cannot be positively identified as nonpoisonous, the bite should be treated as a poisonous bite. Do not delay treatment during this step.

2. Determine the type of snakebite.

**NOTE:** Staying calm and keeping the casualty calm and at rest is critical.

- a. Nonpoisonous.

- (1) Four to six rows of teeth.

- (2) No fangs.

- b. Poisonous.

- (1) Two rows of teeth.

- (2) Two fangs which create puncture wounds.

**WARNING:** Exception is the coral snake, a poisonous snake that does not have fangs. It leaves a semicircular pattern with its teeth as it "chews" the skin.

- (3) Elliptical pupils or vertical slits, much like those of a cat.

- (4) Pit between the eye and mouth.

- (5) A variety of different-shaped blotches on backgrounds of pink, yellow, olive, tan, gray, or brown skin.

**NOTE:** The exception to color is the coral snake which is ringed with red, yellow and black.

- (6) A triangular head that is larger than the neck.

3. Check the casualty for signs and symptoms of a poisonous bite.

**NOTE:** The signs and symptoms of a poisonous snakebite generally occur immediately.

- a. Noticeable bite on the skin which may appear as nothing more than a discoloration.

- b. Pain and swelling in the area of the bite, which may be slow to develop, taking from 30 minutes to several hours.

- c. Rapid pulse and labored breathing.

- d. Progressive general weakness.

- e. Vision problems (dim or blurred).

- f. Seizures.
- g. Shock.
- h. Dizziness or faintness.
- i. Fever, chills, or sweating.
- j. Nausea and vomiting.
- k. Drowsiness or unconsciousness.
- l. Paralysis.
- m. Coma.

**WARNING:** Never delay care and transport in order to capture the snake.

**CAUTION:** Do not give the casualty any sedatives, alcohol, food, or tobacco.

4. Initiate treatment.

*NOTE:* If the dead or captured snake is at the scene, it is not your role to identify the snake, but to place it in a sealed container and transport it along with the casualty.

Never scrub the area or apply a cold pack to snakebites. There may be only one fang mark.

a. Nonpoisonous bite.

(1) Wash the area around the bite gently using a mild or strong soap solution and sterile normal saline.

(2) If the casualty has a current tetanus toxoid series, refer the casualty to the medical officer.

(3) If the casualty does not have a current tetanus toxoid series or does not know, refer the casualty to a medical treatment facility for an immunization.

b. Poisonous bites.

**WARNING:** Do not cut into the bite and suction or squeeze the bite site.

(1) Wash the area around the bite gently using a mild or strong soap solution and sterile normal saline.

(2) Keep the casualty calm and reassured.

(a) Explain to the casualty what will be done.

(b) Limit their physical activity.

(3) Keep any bitten extremities immobilized-the application of a splint will help.

(4) Lower the injection site below the level of the heart.

(5) Remove any rings, bracelets, or other constricting items on the bitten extremity.

*NOTE:* Removing jewelry or other constricting objects from the casualty's affected limb will help in case the limb swells, which would make removal more difficult later.

(6) Call medical direction.

(a) Ask the best receiving facility where antivenom will be most readily available to treat the casualty.

(b) Ask medical direction and follow local protocols in the application of a constricting band in the treatment of a snakebite, proximal to the bite.

5. Record the procedure on FMC.

6. Evacuate the casualty.

a. Rapid transport and administration of antivenom are the most effective interventions for the treatment of life-threatening snakebites.

b. While in route observe the casualty carefully for the signs and symptoms of allergic reaction, monitoring airway, breathing, circulation, vital signs, distal pulse of the bitten extremity, treating for shock, and conserving body heat.

**Evaluation Preparation:**

Setup: For training and evaluation, have another Soldier act a the casualty. Simulate a snakebite on the casualty’s arm or leg or describe its appearance to the Soldier. Coach the casualty on how to answer the Soldier’s questions regarding signs and symptoms such as pain. To test step 2, ask the Soldier what type of bite the casualty has. To test step 3, have the Soldier tell you the symptoms of a poisonous snakebite.

Brief Soldier: Tell the Soldier to treat a casualty for a snakebite.

<b>Performance Measures</b>	GO	NO GO
1 Exposed the injury site.	_____	_____
2 Determined the type of snakebite.	_____	_____
3 Checked the casualty for signs and symptoms of a poisonous bite.	_____	_____
4 Initiated treatment.	_____	_____
5 Recorded the procedure on a FMC.	_____	_____
6 Evacuated the casualty.	_____	_____

**Evaluation Guidance:** Score each Soldier according to the performance measures. Unless otherwise stated in the task summary, the Soldier must pass all performance measures to be scored GO. If the Soldier fails any steps, show what was done wrong and how to do it correctly.

**References**

**Required**  
DD Form 1380

**Related**  
None

## Treat a Casualty for a Cold Injury

081-831-0039

**Conditions:** You encounter a casualty with a cold weather injury. You will need dry clothing or similar material, sterile dressings, a thermometer, and a DD Form 1380 US Field Medical Card (FMC). You are not in a CBRN environment.

**Standards:** Treat the casualty for a cold weather injury without causing further injury.

### Performance Steps

1. Recognize the signs and symptoms of cold injuries.

a. Chilblains are caused by repeated prolonged exposure of bare skin to low temperatures from 60° F down to 32° F.

(1) Acutely red, swollen, hot, tender, and/or itching skin.

(2) Surface lesions with shedding of dead tissue, or bleeding lesions.

b. Frostbite is caused by exposure of the skin to cold temperatures that are usually below 32° F depending on the windchill factor, length of exposure, and adequacy of protection.

*NOTE:* The onset is signaled by a sudden blanching of the skin of the nose, ears, cheeks, fingers, or toes followed by a momentary tingling sensation. Frostbite is indicated when the face, hands, or feet stop hurting.

(1) First Degree.

(a) Epidermal injury; limited to skin that has brief contact with cold air or metal.

(b) No blister or tissue loss; healing occurs in 7-10 days.

(2) Second Degree.

(a) Involves epidermis and superficial dermis.

(b) Redness of the skin in light-skinned individuals and grayish coloring of the skin in dark-skinned individuals, followed by a flaky sloughing of the skin.

(c) Blister formation 24 to 36 hours after exposure followed by sheet-like sloughing of the superficial skin.

(d) No permanent loss of tissue; healing occurs in 3-4 weeks.

(3) Third Degree.

(a) Involves the epidermis and dermis layers.

(b) Frozen skin stiff with restricted mobility.

(c) After tissue thaws, skin swells along with blood-filled blister.

(d) Skin loss occurs slowly; healing is delayed.

(4) Fourth degree.

(a) Frozen tissue involves full thickness skin with muscle and bone involvement.

(b) Necrotic tissue develops along with sloughing of tissue and auto-amputation of nonviable tissue.



**CAUTION:** With generalized hypothermia, the entire body has cooled with the core temperature below 95° F.

c. Generalized hypothermia is caused by prolonged exposure to low temperatures, especially with wind and wet conditions, and it may be caused by immersion in cold water.

(1) Moderate hypothermia.

*NOTE:* This condition should be suspected in any chronically ill person who is found in an environment of less than 50° F.

(a) Conscious, but usually apathetic or lethargic.

(b) Shivering, with pale, cold skin, slurred speech, poor muscle coordination, faint pulse.

(2) Severe hypothermia.

(a) Unconscious or stuporous.

(b) Ice cold skin.

(c) Inaudible heart beat or irregular heart rhythm.

(d) Unobtainable blood pressure.

(e) Unreactive pupils.

(f) Very slow respirations.

d. Immersion syndrome (immersion foot, trench foot and hand) is caused by fairly long (hours to days) exposure of the feet or hands to wet conditions at temperatures from about 50° F down to 32° F.

(1) Minimal.

(a) Increased blood flow to feet.

(b) Slight sensory change for 2-3 days.

(c) Self limiting injury with no signs of injury after 7 days.

(2) Mild.

(a) Edema, hyperemia and sensory changes remain for 2-3 days.

(b) Loss of sensation found on bottom of feet and toes for 4-9 weeks after injury.

(c) Blisters and skin loss does not occur.

(d) Casualty can walk when walking does not cause pain.

(3) Moderate.

(a) Edema, hyperemia, blisters and mottled skin appear 2-3 days after injury.

(b) Loss of sensation and edema for 2-3 weeks.

(c) Blister sloughing occurs, no loss of deep tissue.

(4) Severe.

(a) Severe edema and gangrene present 2-3 days after injury.

(b) Loss of sensation, edema for 2-3 weeks.

(c) Significant tissue loss with auto-amputation.

(d) Casualties will have permanent disability.

e. Snow blindness.

(1) Scratchy feeling in the eyes as if from sand or dirt.

(2) Watery eyes.

(3) Pain, possibly as late as 3 to 5 hours later.

(4) Reluctant or unable to open eyes.

2. Treat the cold injury.

a. Chilblains.

(1) Apply local re-warming within minutes.

**CAUTION:** Do not treat with ointments.

(2) Protect lesions (if present) with dry sterile dressings.

b. Frostbite.

**CAUTION:** Avoid thawing the affected area if it is possible that the injury may refreeze before reaching the treatment center.

(1) Apply local re-warming using body heat.

(2) Loosen or remove constricting clothing and remove jewelry.

**CAUTION:** Do not massage the skin or rub anything on the frozen parts.

(3) Increase insulation and exercise the entire body as well as the affected body part(s).

(4) Move the casualty to a sheltered area, if possible.

(5) Fingers and toes should be separated and protected with dry sterile gauze.

(6) Protect the affected area from further cold or trauma.

(7) Evacuate the casualty.

*NOTE:* For frostbite of a lower extremity, evacuate the casualty by litter, if possible.

**CAUTION:** Do not allow the casualty to use tobacco or alcohol.

c. Generalized hypothermia.

(1) Moderate.

(a) Remove the casualty from the cold environment.

(b) Replace wet clothing with dry clothing.

(c) Cover the casualty with insulating material or blankets.

(d) Avoid unnecessary movement from the casualty.

*NOTE:* If far from a medical treatment facility and the situation and facilities permit, immerse the casualty in a tub of 104-108° F water. Avoid re-warming with intense sources of heat (campfire).

**CAUTION:** Do not give the casualty alcohol or caffeine drinks.

(e) If casualty is conscious, slowly give high caloric sweet warm fluids.

- (f) Wrap the casualty from head to toe.
- (g) Evacuate the casualty lying down.

**CAUTION:** Handle the casualty very gently.

- (2) Severe.
  - (a) Cut away wet clothing and replace it with dry clothing.
  - (b) Maintain the airway. (See task 081-831-0018.)

*NOTE:* Do not use artificial airways or suctioning devices.

**CAUTION:** Do not hyperventilate the casualty. Keep the rate of artificial ventilation at approximately 8 to 10 per minute.

- o Administer oxygen.
- o Assist with ventilation if the casualty's respiration rate is less than five per minute.

*NOTE:* Do not use artificial airways or suctioning devices.

(c) Initiate an intravenous (IV) infusion of any crystalloid fluid, warmed up to 109° F . Do not infuse cold IV fluids.

- (d) Evacuate the casualty.

*NOTE:* The treatment of moderate hypothermia is aimed at preventing further heat loss and re-warming the casualty as rapidly as possible. Re-warming a casualty with severe hypothermia is critical to saving his life, but the kind of care re-warming requires is nearly impossible to carry out in the field. Evacuate the casualty promptly to a medical treatment facility. Use stabilizing measures en route.

- d. Immersion syndrome.

**CAUTION:** Never massage the skin. After re-warming the affected part, it may become swollen, red, and hot. Blisters usually form due to circulation return.

- (1) Dry the affected part immediately and gradually re-warm it in warm air.
- (2) Protect the affected part from trauma and secondary infection.
- (3) Fingers and toes should be separated and protected with a dry sterile gauze.
- (4) Elevate the affected part.
- (5) Evacuate the casualty as soon as possible.

e. Snow blindness. Cover the eyes with a dark cloth and evacuate the casualty to a medical treatment facility.

### **Evaluation Preparation:**

Setup: For training and evaluation have another Soldier act as the casualty. Select one of the types of cold injuries on which to evaluate the Soldier. Coach the simulated casualty on how to answer questions about symptoms. Physical signs and symptoms that the casualty cannot readily simulate, for example blisters, must be described to the Soldier.

Brief Soldier: Tell the Soldier to determine what cold injury the casualty has. After the cold injury has been identified, ask the Soldier to describe the proper treatment.

**Performance Measures**

GO      NO GO

1 Recognized the signs and symptoms of cold injuries.

\_\_\_\_\_

2 Treated the cold injury.

\_\_\_\_\_

**Evaluation Guidance:** Score each Soldier according to the performance measures. Unless otherwise stated in the task summary, the Soldier must pass all performance measures to be scored GO. If the Soldier fails any steps, show what was done wrong and how to do it correctly.

**References**

**Required**  
SF 600

**Related**  
None

**Skill Level SL2**  
**Subject Area 12: Medical Treatment**  
**Remove a Toenail**  
**081-833-0196**

**Conditions:** You have a patient requiring a toenail extraction. You will need a medical officer's order for a toenail extraction, appropriate antimicrobial solution, sterile normal saline or sterile water, non adherent dressing, 3-5ml syringe with two long (1-1.5 inches) needles (25G and 21G (gauge)), 1% lidocaine local anesthetic without epinephrine, nail anvil splitter (English), two sterile forceps or hemostats (straight), sterile cotton-tipped applicators, penrose drain used as a tourniquet, 4 x 4 sterile gauze sponges, dressing materials, infectious waste receptacle, sharps container, tape, and SF 600 (Chronological Record of Medical Care), and pen. You are not in a CBRN environment.

**Standards:** Perform partial or complete toenail removal in accordance with (IAW) established protocols without causing harm or further injury to patient.

*NOTE:* When irritation and/or infection are more widespread or include the entire toe, removal of a portion of the nail and debridement of the inflamed tissue may be required. Toenail removal may be total or partial. Total nail removal is rarely needed but may be used when infection of both lateral nailfolds is present, particularly if the condition is present for more than a month.

**Performance Steps**

1. Solicit a patient history and verify patient's signature on consent form.
2. Gather equipment.
3. Prepare the patient.
  - a. Explain procedure.
  - b. Place the patient supine with knees flexed and feet flat.
  - c. Cleanse the digit with an antimicrobial scrub.
  - d. Exsanguinate the toe by squeezing or wrapping, and apply a tourniquet at the base of the toe.
  - e. Apply sterile drapes to completely surround the wound and to cover all unprepared areas adjacent to the site.
  - f. Administer local anesthetic by ring block technique.
    - (1) Digital cutaneous nerves run along the medial and lateral aspects of each digit and can be blocked at any level above the distal phalanx.
    - (2) Use the 25 gauge needle to raise a skin wheal by administering approximately 0.25ml of the anesthetic directly over the lateral and medial cutaneous nerve.
    - (3) Change to 21 gauge needle and advance the needle perpendicular to the nerve until bone is reached; inject approximately 1ml of the anesthetic.
    - (4) Slide the needle up and down on the dorsal and volar aspects of the digit; injecting approximately 0.5ml of the anesthetic in each side.
    - (5) Discard used needles and syringe in sharp's container immediately after use.
    - (6) It takes 5 to 10 minutes for complete anesthesia to develop.
4. Partial toenail removal.

- a. Perform a patient care hand wash and put on sterile gloves.
- b. Once anesthesia has been achieved, use a straight hemostat to firmly secure a wide rubber band around the base of the digit to serve as a tourniquet.
- c. Stabilize the digit in the non-dominant hand.

**CAUTION:** Take care to perform a controlled division along the longitudinal lines of the nail for several millimeters past the proximal nailfold (cuticle).

- d. Insert a single blade of the other straight hemostat between the nail bed and the nail to loosen and lift the nail. Split the nail with nail splitter in a longitudinal direction (distal to proximal) to include the base of the nail that rests beneath the cuticle.

*NOTE:* An English anvil nail splitter is desirable to begin the procedure, but sharp scissors or a No. 11 blade will work.

- e. With the second straight hemostat, grasp the portion of the loosened nail and remove it using a steady pulling motion with a simultaneous upward twist of the hand toward the affected side completely removing the section of the nail.

- f. Debride the nail groove.

- (1) Inspect the remnant to be certain that the entire piece of nail has been removed as desired.

- (2) Sharply remove any remaining or swollen/heaped-up skin and all hyperkeratotic debris.

- g. Remove the tourniquet and assess for hemostasis.

- h. Apply a topical antibiotic ointment (not containing neomycin) to the nail bed and cover the digit with a sterile nonadherent dressing, followed by a dry sterile wrap or tubular gauze and tape in place.

- i. Discard soiled/blood soaked gauze and disposable drapes in infectious waste receptacle, IAW infection control guidelines and local facilities SOP.

- j. Cleanse all instruments used in procedure IAW local facilities SOP.

- k. Remove gloves.

- l. Wash hands.

#### 5. Complete toenail removal.

- a. Perform a patient care handwash and put on sterile gloves.
- b. Once anesthesia has been achieved, use a straight hemostat to firmly secure a wide rubber band around the base of the digit to serve as a tourniquet.
- c. Stabilize the digit in the nondominant hand.

**CAUTION:** It is important to completely free the proximal nail at its base (under the edge of the cuticle) to allow removal and to expose the germinal tissue of the nail bed.

- d. Insert a single blade of the other straight hemostat (or the periosteal elevator) between the nail bed and the toenail to loosen and lift the nail; advance the instrument with a continued upward pressure against the nail and away from the nail bed to minimize injury and bleeding.

e. With the second straight hemostat, grasp the loosened nail and remove it using a steady pulling motion with a simultaneous upward twist of the hand toward the affected side completely removing the nail.

f. Debride the nail grooves as needed.

(1) Inspect the remnant to be certain that the entire piece of nail has been removed as desired.

(2) Sharply remove any remaining or swollen/heaped-up skin and all hyperkeratotic debris.

g. Remove the tourniquet and assess for hemostasis.

h. Apply a topical antibiotic ointment to the nail bed and cover the digit with a sterile gauze sponge dressing or tubular gauze and tape in place.

i. Discard soiled/blood soaked gauze and disposable drapes in infectious waste receptacle, IAW infection control guidelines and local facilities SOP.

j. Cleanse all instruments used in procedure IAW local facilities SOP.

k. Remove gloves.

l. Wash hands.

6. Provide patient follow-up instructions.

a. Rest the foot (toe) during the initial 24 hours after the procedure.

b. Elevate the extremity when possible.

c. Return in 24 hours for dressing change, at which time you should re-apply the topical antibiotic ointment, apply a less bulky dressing and encourage ambulation and a return to normal activity within the next 48 hours.

d. Soaking the open wound in warm water for 20 minutes, twice a day is soothing and allows the patient to view the healing process.

e. Tell patient to expect some clear to yellow fluid drainage (exudate) from the toe that may continue for three weeks. Complications include nail regrowth, infection, growth of an inclusion cyst, and delayed healing.

*NOTE:* If the condition returns, podiatric referral is recommended for more extensive nailbed ablation.

f. Emphasize proper toenail hygiene and schedule a follow-up visit for 30 days to assess healing.

7. Document the procedure on SF 600.

a. Patient's tolerance of procedure.

b. Teaching instructions given patient.

### **Evaluation Preparation:**

Setup: Use a simulation device capable of toenail removal surgical procedures.

<b>Performance Measures</b>	GO	NO GO
1 Solicited a patient history and verified patient's signature on consent form.	_____	_____
2 Gathered equipment.	_____	_____
3 Prepared the patient.	_____	_____
4 Removed partial toenail.	_____	_____
5 Removed complete toenail.	_____	_____
6 Provided patient follow-up instructions.	_____	_____
7 Documented the procedure on the SF 600.	_____	_____

**Evaluation Guidance:** Score each Soldier according to the performance measures. Unless otherwise stated in the task summary, the Soldier must pass all performance measures to be scored GO. If the Soldier fails any steps, show what was done wrong and how to do it correctly.

**References**

**Required**  
SF 600

**Related**  
None



## Initiate Treatment for a Paronychia

**081-833-0024**

**Conditions:** You have a patient with a paronychia. You will need a scalpel handle, scalpel blades of various sizes, antibiotic ointment, sterile dressing, gloves, and SF 600 (Medical Record - Chronological Record of Medical Care). You are not in a CBRN environment.

**Standards:** Provide drainage for a patient's paronychia without causing further injury to the patient.

### Performance Steps

1. Recognize signs and symptoms of a paronychia.
  - a. Swelling and tenderness of the soft tissue along the base or side of a fingernail.
  - b. Pain, often around a hangnail.
  - c. Infection begins as a cellulitis and may form an abscess.
2. Obtain a history of the patient's complaint.
3. Gather the materials for the procedure.
4. Perform a patient care handwash.
5. Put on gloves.
6. Explain the procedure to the patient.
7. Drain the paronychia.
  - a. Often, an incision is unnecessary. Instead, insert the tip of a No.11 blade approximately 5 mm under the surface of the nail, uplifting the cuticle, thus providing an escape for the collected suppurative material.

*NOTE:* This procedure alone provides for adequate drainage in most paronychias.

- b. Allow the pus to drain.
- c. Irrigate the cavity with normal saline.
- d. Apply antibiotic ointment and absorbent dry, sterile dressing.
- e. Instruct the patient to perform frequent soaks in warm tap water at home and continue to keep the wound covered as long as drainage persists.

*NOTE:* Culture and antibiotic therapy are usually unnecessary unless the patient shows signs of systemic infection.

8. Remove gloves.
9. Instruct the patient to follow up in 24-48 hours. Instruct the patient to follow up earlier if there are signs of systemic infection.
10. Record all treatment given on SF 600.

### Evaluation Preparation:

This task is best evaluated by verbalization of the steps. Give the Soldier a simulated patient and a scenario in which he must drain a paronychia.

**Performance Measures**

	GO	NO GO
1 Recognized signs and symptoms of a paronychia.	_____	_____
2 Obtained a history of the patient's complaint.	_____	_____
3 Gathered the materials for the procedure.	_____	_____
4 Performed hand washing procedure.	_____	_____
5 Put on gloves.	_____	_____
6 Explained the procedure to the patient.	_____	_____
7 Drained the paronychia.	_____	_____
8 Removed gloves.	_____	_____
9 Instructed the patient to follow up in 24-48 hours.	_____	_____
10 Recorded all treatment given on SF 600.	_____	_____

**Evaluation Guidance:** Score each Soldier according to the performance measures. Unless otherwise stated in the task summary, the Soldier must pass all performance measures to be scored GO. If the Soldier fails any steps, show what was done wrong and how to do it correctly.

**References**

**Required**  
SF 600

**Related**  
Clinical Dermatology

## Insert a Urinary Catheter

**081-833-3017**

**Conditions:** You have a medical officer's order for urinary catheterization of an adult patient. You will need an adult disposable #14 to #16 (French) (latex or silicone) catheter, drainage bag attached set, sterile gloves, betadine swabs, benzalkonium chloride antiseptic cleaning agent (in case patient has an allergy to betadine or iodine) located inside kit, a penlight/flashlight or standing lamp, chux pads, sheet for draping, pen and an SF 600 (Medical Record-Chronological Record of Medical Care). You are not in a CBRN environment.

**Standards:** Insert a urinary catheter without violating aseptic technique or causing further injury to the patient.

### Performance Steps

1. Perform a patient care handwash.
2. Confirm the patient's identity and inquire about allergies to betadine solution or betadine prep swabs and allergies to tape, in accordance with, (IAW) local standard operating procedures (SOP).
  - a. Use two patient identifiers.
    - (1) Ask patient state his full name.
    - (2) Ask patient his date of birth (DOB).
  - b. Check patient for allergy band.
  - c. Check patient's chart for any known drug allergies.
3. Explain the procedure to the patient.

*NOTE:* Patient will feel reassured if the procedure is explained and if they are handled gently and considerately.

4. Position the patient.

*NOTE:* Elevate bed to a height/position of comfort for you while performing procedure and raise the top two side rails for patient safety.

- a. Provide privacy for the patient.
- b. Place patient in a supine position with knees bent, hips flexed and feet resting on the bed.
5. Direct light for visualization of genital area.
6. Position chux pads between patient's legs and under the hips.
7. Put on sterile gloves.
8. Prepare catheterization kit.
  - a. Open catheter tray using aseptic technique.
  - b. To create the sterile field, open the prepackaged kit or equipment tray and place it between the female patient's legs.
  - c. For male patient place it next to their hip.
9. Place the sterile drape under the patient's hips.

10. Drape the patient's lower abdomen with the sterile fenestrated drape so that only the genital area remains exposed.

*NOTE:* Take care not to contaminate your sterile gloves.

11. Open the rest of the kit or tray.

12. Tear open the packet of antiseptic cleaning agent.

*NOTE:* Be careful not to spill the solution on the equipment.

a. Saturate the sterile cotton balls or applicators.

b. Open the packet of water-soluble lubricant and apply it to the catheter tip.

c. Make sure all tubing ends remain sterile and make sure the clamp at the emptying port of the drainage bag is closed to prevent urine leakage from the bag.

d. Before inserting the catheter, inflate the balloon.

(1) Attach the prefilled syringe to the luer-lock.

(2) Push the plunger and check for seepage as the balloon expands.

(3) Aspirate the water to deflate the balloon.

*NOTE:* Beware that some manufacturers recommend not inflating the balloon prior to insertion because of the risk of microtears that may cause infection. If you are unsure, check the manufacturer's instructions that are included with the kit.

13. Insert the catheter.

*NOTE:* Bacteria that normally colonize the distal urethra may be introduced into the bladder during or immediately after catheter insertion.

a. Female.

(1) Separate labia majora and the labia minora as widely as possible with the thumb, middle and index fingers of your non-dominant hand so you have a full view of the urinary meatus.

(2) Keep the labia well separated throughout the procedure so they don't obscure the urinary meatus or contaminate the area when it's cleaned.

*NOTE:* This maneuver helps prevent labial contamination of the catheter.

**WARNING:** Do not contaminate your sterile gloved hand.

(3) With your dominant hand, use a sterile, cotton-tipped applicator (or pick up a sterile cotton ball with the plastic forceps).

(a) Wipe one side of the urinary meatus with a single downward motion.

(b) Dispose of the cotton-tipped applicator or cotton ball after use.

(c) Secure another sterile applicator or cotton ball and wipe the other side of the urinary meatus with a single downward motion disposing after use.

(d) Secure a third sterile applicator or cotton ball and wipe directly over the meatus and dispose after use.

**WARNING:** Too large of a catheter may cause painful distention of the meatus and cause damage to the uroepithelium.

(4) Introduce the well lubricated catheter 2-3 inches (5-7.5 cm) into the urethral meatus using strict aseptic technique, while continuing to hold the labia apart.

*NOTE:* If the catheter is inadvertently inserted into the vagina, leave it there as a landmark. Remove gloves, obtain another sterile set and then begin the procedure over again using new sterile supplies.

- (a) Avoid contaminating surface of the catheter.
- (b) Make sure that the catheter is not too large or too tight at the urethral meatus.
- (c) Advance the catheter almost to the bifurcation.

*NOTE:* If catheter is correctly placed, you should see a urine flow through tubing and into the drainage bag.

b. Male.

- (1) Hold the penis with your non-dominant hand.
- (2) If the patient is uncircumcised, retract the foreskin.
- (3) Gently lift and stretch the penis to a 60 to 90 degree angle. Continue holding the penis this way throughout the procedure to straighten the urethra and maintain a sterile field.
- (4) Use your dominant hand to clean the glans with a sterile cotton-tipped applicator or a sterile cotton ball held in the forceps.
- (5) Clean in a circular motion, starting at the urinary meatus and working outward, disposing the applicator or cotton ball after use.
- (6) Repeat the cleaning procedure two more times, disposing of the cotton-tipped applicator or cotton ball after each use.
- (7) Inject 5-10 ml of water-soluble lubricant or water-soluble 2% lidocaine jelly directly into the urethra.
- (8) Pick up the catheter with your dominant hand, and prepare to insert the lubricated tip into the urinary meatus.

**WARNING:** Never force a catheter during insertion. Maneuver gently as the patient bears down or coughs. If you still meet resistance, stop and notify the medical officer.

- (9) To facilitate insertion by relaxing the sphincter, ask the patient to cough as you insert the catheter.
  - (a) Tell him to breath deeply and slowly to further relax the sphincter and spasms.
  - (b) Hold the catheter close to its tip to ease insertion and control its direction.
- (10) Advance the catheter to the bifurcation.

*NOTE:* With some commercially prepared catheterization kits, the catheter is pre-connected to the drainage tubing of the collecting bag.

- (a) Check for urine flow.
- (b) If foreskin was retracted, replace it to prevent compromised circulation and painful swelling.

**WARNING:** Never inflate the balloon without first establishing urine flow.

**CAUTION:** Make sure the catheter is draining properly before inflating the balloon, then withdraw the catheter slightly.

14. Inflate balloon (male and female patients).

*NOTE:* Inflation of balloon will keep the catheter in place in the bladder.

- a. Push the plunger of your prefilled syringe.
- b. Inject 5-10 ml of sterile water, or IAW with manufacturer's directions when urine stops flowing.
- c. Remove syringe after inflation of balloon from the luer-lock post of catheter.
- d. Hang the collection bag below bladder level to prevent urine reflux into the bladder and to facilitate gravity drainage of the bladder.

15. Tape and secure the catheter.

- a. Tape catheter to thigh to prevent possible tension on the urogenital trigone in female patients.
- b. Tape the catheter to the male patient's abdomen or thigh to prevent pressure on the urethra at the penoscrotal junction.

*NOTE:* The penis may be positioned up or down (facing the patient's head or feet), depending upon the patient's diagnosis, the medical officer's order, and/or the patient's comfort preference.

- c. Alternatively, you can secure the catheter to the patient's thigh using a leg band with a Velcro closure.

*NOTE:* Securing of catheter with Velcro closure decreases skin irritation, especially in patients with long term indwelling catheters.

**CAUTION:** Do not secure the drainage bag to the bed side rails or loop the drainage tubing over or through the side rails.

16. Secure the drainage bag to the side of the bed on the bottom of the bed frame.

17. Reposition the patient.

- a. Lower patient's bed back down and make sure brake is in locked position.
- b. Lower upper side rails as appropriate on patient's bed.

18. Dispose of all used supplies properly IAW local infection control SOP.

- a. Prefilled syringe should be disposed of in sharp's container and not waste receptacle.
- b. Remove and dispose of gloves and wash hands.

19. Remove gloves.

20. Document on SF 600.

- a. Patient's tolerance of procedure.
- b. Amount of urine in foley bag.
- c. Note any color, odor (if any detected), and sedimentation if any.

**Evaluation Preparation:**

Setup: Use a simulated patient mannequin that can accept a urinary catheter.

Brief Soldier: Tell the Soldier to insert a urinary catheter.

<b>Performance Measures</b>	GO	NO GO
1 Performed a patient care handwash.	_____	_____
2 Confirmed patient identity and allergies.	_____	_____
3 Explained procedure to patient.	_____	_____
4 Positioned patient.	_____	_____
5 Directed light for visualization of genital area.	_____	_____
6 Placed chux pads between patient's legs and under the hips.	_____	_____
7 Put on sterile gloves.	_____	_____
8 Prepared catheterization kit.	_____	_____
9 Placed the sterile drape under patients hips.	_____	_____
10 Draped the patient's lower abdomen with the sterile fenestrated drape so that only the genital area remains exposed.	_____	_____
11 Opened the rest of the kit or tray.	_____	_____
12 Tore open the packet of antiseptic cleaning agent.	_____	_____
13 Inserted the catheter.	_____	_____
14 Inflated the balloon.	_____	_____
15 Taped and secured the catheter.	_____	_____
16 Secured the drainage bag to the side of the bed on the bottom of the bed frame.	_____	_____
17 Repositioned the patient.	_____	_____
18 Disposed of all used supplies properly IAW local infection control SOP.	_____	_____
19 Removed gloves.	_____	_____
20 Documented procedure on SF 600.	_____	_____

**Evaluation Guidance:** Score each Soldier according to the performance measures in the evaluation guide. Unless otherwise stated in the task summary, the Soldier must pass all performance measures to be scored GO. If the Soldier fails any step, show what was done wrong and how to do it correctly.

**References**

**Required**  
SF 600

**Related**  
None

## Insert a Nasogastric Tube

081-833-3022

**Conditions:** You have a patient requiring a nasogastric (NG) tube. You will need a NG tube (single lumen Levin or double-lumen Salem sump tube), water soluble lubricant, suction equipment if ordered, clamp for tubing, towel, tissues, and emesis basin, glass of water and straw, tincture of benzoin, hypoallergenic tape: 1/2 inch and 1 inch, bio-occlusive transparent dressing, irrigating set with 20-ml syringe or a 50-ml catheter-tip syringe, clean stethoscope, tongue blade, penlight, disposable gloves, normal saline, pen, and SF 510 (Nursing Notes) or a SF 600 (Medical Record-Chronological Record of Medical Care). You have performed a patient care handwash and you are not in a CBRN environment.

**Standards:** Insert a nasogastric (NG) tube without causing injury to the patient.

### Performance Steps

1. Assemble equipment.

*NOTE:* NG tubes may be contraindicated in patients with nasopharyngeal or esophageal obstruction, severe, uncontrolled coagulopathy or severe maxillofacial trauma.

2. Explain the procedure to the patient.
  - a. Ask patient if they have ever had nasal surgery, trauma, a deviated septum or bleeding disorder.
  - b. Explain that mouth breathing, panting, and swallowing will make it easier to insert the tube.
  - c. Tell the patient that the tube will be inserted along the nasal passage.
  - d. Explain that the procedure may cause him or her to gag and bring tears to his or her eyes.
3. Put on gloves.
4. Place patient in a sitting or high-Fowler's position; place a towel across the chest.

*NOTE:* This will facilitate the passage of the tube into the esophagus.

- a. If the patient is unconscious, place him on his left side with the uppermost arm flexed across the abdomen or supported on the body and hip.
- b. Determine with the patient what sign he might use, such as raising the index finger, to indicate "wait a few moments" because of gagging or discomfort.
- c. Remove dentures; place emesis basin and tissues within patient's reach.

*NOTE:* Dentures may become loose and interfere with tube insertion.

5. Inspect the tube for defects; look for partially closed holes or rough edges.

*NOTE:* Irrigation and suction may be affected by a defective tube.

6. Place rubber tubing in ice-chilled water for a few minutes to make the tube firmer.

*NOTE:* Plastic tubing may already be firm enough; if too stiff, dip in warm water.

7. Determine the length of the tube needed to reach the stomach.

*NOTE:* Determining the correct length will prevent coiling of the tube in the stomach or having the tube end in the esophagus.

- a. Measure the patient's nose, earlobe and xiphoid (NEX), and mark the tube appropriately.



- b. The distance from the nose to the earlobe is the first mark on the tube. This measurement represents the distance to the nasal pharynx.
- c. When the tube reaches the xiphoid process (tip of the breast bone) a second mark is made on the tube. This measurement represents the length required to reach the stomach.
- 8. Inspect the nostrils with a penlight, observing for any obstruction.
  - a. Have the patient blow nose to clear nostrils.
  - b. Occlude each nostril and have the patient breathe.
- 9. Insert NG tube.
  - a. Coil the first 3-4 inches (7.5-10 cm) of the tube around your fingers.

*NOTE:* This curves tubing and facilitates tube passage.

- b. Lubricate the coiled portion of the tube with water-soluble lubricant, avoid occluding the tube's holes.

*NOTE:* Lubrication reduces friction between the mucous membranes and tube and prevents injury to the nasal passages. Using a water-soluble lubricant prevents oil aspiration pneumonia if the tube accidentally slips into the trachea.

- c. Tilt the patient's head back before inserting tube into nostril and gently pass the tube into the posterior nasopharynx, directing downward and backward toward the ear.

*NOTE:* The passage of the tube is facilitated by following the natural contours of the body. The slower the advancement of the tube at this point, the less likelihood of putting pressure on the turbinates, which could cause pain and bleeding.

- d. When the tube reaches the pharynx, the patient may gag; allow patient to rest for a few moments.
- e. Have the patient tilt the head slightly forward.

(1) Offer several sips of water through a straw or have patient suck on ice chips if not contraindicated.

- (2) Advance the tube as patient swallows.

*NOTE:* Flexed head position partially occludes the airway, and the tube is less likely to enter the trachea. Swallowing closes the epiglottis over the trachea and facilitates passage of the tube into the esophagus.

**CAUTION:** If there are signs of distress, such as gasping, coughing or cyanosis, immediately remove the tube.

- f. Gently rotate the tube 180 degrees to redirect the curve.

*NOTE:* This prevents the tube from entering the patient's mouth.

If obstruction appears to prevent tube from passing, do not use force. Rotating the tube may help. If unsuccessful, remove tube and try other nostril.

- g. Continue to advance tube gently each time the patient swallows.
- h. Continue to advance tube until the tape mark reaches the patient's nostril.

- 10. Check tube placement.

- a. Check whether the tube is in the stomach.
  - (1) For a conscious patient, ask the patient to talk.

(2) For an unconscious patient, use the tongue blade and penlight to examine the patient's mouth to assess proper placement of the NG tube through the posterior pharynx.

*NOTE:* The presence of stomach contents in the tube or syringe indicates correct placement.

b. Auscultation.

(1) Position the diaphragm of the stethoscope over the patient's stomach (about 2 inches below the sternum).

(2) Inject 10 cc of air into the tube.

(3) Listen for the sound of the air entering the stomach (gurgling or whooshing sound) which indicates correct tube placement. Proceed to step 14 if placement is correct.

(4) Check for tube placement in the trachea if air is not heard entering the stomach.

(a) Reinject 10 cc of air into the tube.

(b) Auscultate over the lung field.

(c) Remove the tube if air injection is heard over the lungs.

(5) Repeat steps to reinsert the tube.

11. Secure the tube to the patient's nose with the tape and wrap the two ends of tape around the tube.

12. Connect the tube to the suction apparatus, if ordered.

13. Remove gloves and wash hands.

14. Report and record the procedure on SF 510 or SF 600.

**Evaluation Preparation:**

Setup: For training and evaluation, use a simulation device capable of accepting a nasogastric tube.

Brief Soldier: Tell the Soldier the simulated patient requires a nasogastric tube to be inserted.

**Performance Measures**

	GO	NO GO
1 Assembled equipment.	_____	_____
2 Explained the procedure to the patient.	_____	_____
3 Put on gloves.	_____	_____
4 Placed patient in a sitting or high-Fowler's position.	_____	_____
5 Inspected the tube for defects.	_____	_____
6 Placed rubber tubing in ice-chilled water. (if too stiff, dipped in warm water).	_____	_____
7 Determined length of tube needed to reach the stomach.	_____	_____
8 Inspected the nostrils with a penlight.	_____	_____
9 Inserted the NG tube.	_____	_____
10 Checked tube placement.	_____	_____
11 Secured the tube to the patient's nose with the tape and wrapped the two ends of tape around tube.	_____	_____

**Performance Measures**

GO      NO GO

12 Connected the tube to the suction apparatus, if ordered.      \_\_\_\_\_      \_\_\_\_\_

13 Removed gloves and washed hands.      \_\_\_\_\_      \_\_\_\_\_

14 Reported and recorded the procedure on SF 510 or SF 600.      \_\_\_\_\_      \_\_\_\_\_

**Evaluation Guidance:** Score each Soldier according to the performance measures in the evaluation guide. Unless otherwise stated in the task summary, the Soldier must pass all performance measures to be scored GO. If the Soldier fails any step, show what was done wrong and how to do it correctly.

**References****Required**

SF 600

SF 510

**Related**

None

## Insert an Orogastric Tube

081-833-0187

**Conditions:** You have a patient requiring an orogastric tube. You will need surgical lubricant, a large (50 or 60 cc) syringe, an orogastric tube, a small (10 to 20 cc) syringe, a container for contaminated waste, adhesive tape, stethoscope, gloves, water, small cup, a drinking straw, pen and SF 600 (Medical Record-Chronological Record of Medical Care). You have performed a patient care hand wash and you are not in a CBRN environment.

**Standards:** Insert an orogastric tube without causing further harm to the patient.

### Performance Steps

1. Determine if the indicators for performing orogastric intubation are present.
  - a. Patient with mid-facial trauma.
  - b. Gastric distention which impedes airway, breathing and circulation (ABC).
    - (1) Full arrest.
    - (2) Near drowning.
  - c. Intestinal obstruction.
  - d. Preoperative and postoperative care.
  - e. Patient requires a gastrointestinal lavage.
    - (1) Overdose.
    - (2) Gastrointestinal bleeding.
  - f. Patient requires a gavage.
    - (1) Comatose patients.
    - (2) Debilitated patients.
  - g. Need to analyze stomach contents.
    - (1) Patient may be bleeding internally.

**WARNING:** Orogastric tube insertion is contraindicated in patients with esophageal strictures, ingested caustics, significant facial or head trauma or patients with bleeding disorders.

**CAUTION:** Insertion of an orogastric (OG) tube into trachea/lung, patient may experience respiratory distress. If this occurs at any time during the procedure, remove the tube immediately.

- (2) Overdose.

**WARNING:** Wear gloves for self-protection against transmission of contaminants whenever handling body fluids.

2. Put on gloves.
3. Identify the patient.
  - a. Ask the patient's name and date of birth (DOB).
  - b. Check the identification band against the chart as appropriate.

4. Explain the procedure to the patient.
  - a. Explain the reason for the orogastric tube.
  - b. Explain the procedure and assess their capability of cooperating with the procedure.

*NOTE:* It is not advisable to explain the procedure too far in advance because the patient's anxiety about the procedure may interfere with its success.

- c. Tell the patient that a tube will be inserted along the oral passage and that he may feel some discomfort.
  - d. Tell the patient that breathing through the nose/mouth, panting, and swallowing can help in passing the tube.

*NOTE:* It is important that the patient relax, swallow and cooperate during the procedure.

- e. Ask the patient about any history of oral or esophageal injury.
  - f. Tell the patient that the tube must be placed about 20 inches down the oral passageway.
  - g. Tell the patient that the procedure may cause him to gag.
5. Examine the patient's oral cavity. Ensure that there are no obstructions in the oral cavity.
6. Position the patient.

- a. Position the responsive, awake, and alert patient in the Fowler's position. Elevate the head of the bed to about 30 to 45 degrees.

- b. Place a comatose or unconscious patient in the lateral position (turn the patient onto his side).

7. Prepare the equipment.

- a. Select the correct type and size of orogastric tube to use.
  - b. Cut four or five pieces of tape 3 to 4 inches long and attach one end of each where they will be easily accessible.
  - c. Unwrap the tube from the plastic wrapper.
  - d. Measure the combined distance between the corner of the mouth to the ear lobe to the xiphoid process. Mark this spot with a small piece of temporary tape.

*NOTE:* Each patient will have a slightly different terminal insertion point. Measurements must be made for each individual's anatomy.

- e. Lubricate 5 to 6 centimeters of the distal end of the tube with water-soluble lubricant.

*NOTE:* The tube slides in more easily if well lubricated. The mucosa is less likely to be damaged during insertion.

8. Insert the lubricated tip of the tube into the oropharynx.
9. Advance the tube into the esophagus.
10. Continue advancing the tube until the tape marker touches the lips.
11. Check and confirm the tube is correctly placed by at least two methods.
  - a. Aspiration of stomach contents.

*NOTE:* Stomach contents will appear cloudy, green, tan, off white, bloody or brown.

- b. Injection of 30-60 ml of air into tube as you auscultate for the sound of air over the epigastric region.

12. Using tape, secure the tube to the patient's cheek.

*NOTE:* The goal of securing the tube in place is to prevent peristaltic movement from advancing the tube or from accidentally being pulled out.

13. Connect the tube to the suction apparatus when required.
14. Remove the gloves and wash your hands.
15. Record the procedure and patient's tolerance of procedure on the SF 600.

**Evaluation Preparation:**

This task is best evaluated by performance of the steps. Give the Soldier a scenario in which he must perform orogastric intubation.

<b>Performance Measures</b>	GO	NO GO
1 Determined if the indicators for performing orogastric intubation were present.	_____	_____
2 Put on gloves.	_____	_____
3 Identified patient.	_____	_____
4 Explained the procedure to the patient.	_____	_____
5 Examined the patient's oral cavity.	_____	_____
6 Positioned the patient.	_____	_____
7 Prepared the equipment.	_____	_____
8 Inserted the lubricated tip of the tube into the oropharnx.	_____	_____
9 Advanced the tube into the esophagus.	_____	_____
10 Continued advancing the tube until the tape marker touched the lips.	_____	_____
11 Checked and confirmed tube placement by at least two methods.	_____	_____
12 Taped and secured the tube to the patient's cheek.	_____	_____
13 Connected the tube to the suction apparatus when required.	_____	_____
14 Removed the gloves and washed hands.	_____	_____
15 Recorded the procedure and patient's tolerance of procedure on the SF 600.	_____	_____

**Evaluation Guidance:** Score each Soldier according to the performance measures. Unless otherwise stated in the task summary, the Soldier must pass all performance measures to be scored GO. If the Soldier fails any steps, show what was done wrong and how to do it correctly.

**References**

**Required**  
SF 600

**Related**  
None

## Remove a Nasogastric Tube

081-833-3023

**Conditions:** You have verified the medical officer's order to discontinue a NG (nasogastric tube). You will need the patient's clinical record, emesis basin, disposable gloves, towel, lip pomade, mouth hygiene materials, pen, container for contaminated waste, and SF 510 (Nursing Notes). The nasogastric tube has been disconnected from the suction machine, if necessary. You have performed a patient care handwash and you are not in a CBRN environment.

**Standards:** Remove a nasogastric tube without causing injury to the patient.

### Performance Steps

1. Turn the patient's head to the side.

**WARNING:** Wear gloves for self-protection against transmission of contaminants whenever handling body fluids.

2. Put on disposable gloves.
3. Remove the tape from the patient's nose.
4. Instruct the patient to take a deep breath and hold it.

**NOTE:** This maneuver closes the epiglottis.

5. Clamp or pinch off the end of the tube to prevent release of gastric contents.
6. Remove the tube.

**CAUTION:** If resistance is felt, do not attempt to remove the tube and notify the supervisor.

- a. Slowly, but evenly, withdraw tubing.

**CAUTION:** If the nasogastric tube is removed carelessly, damage could be done to the tissue of the nasogastric passageway.

- b. Cover it with a towel as it emerges.

**NOTE:** If the patient vomits, stop the procedure immediately. Hand the patient an emesis basin or place it under their chin. Hand the patient a clean towel or wipe the patient's chin and face with the towel. Continue the procedure when the patient is ready.

- c. Provide the patient with materials for oral care and lubricant for nasal dryness.

**NOTE:** Mouthwash and a nasal lubricant will be appreciated by the patient.

7. Dispose of soiled equipment in the container for contaminated waste in accordance with (IAW) infection control policy.

8. Remove soiled gloves.
9. Perform a patient care handwash.
10. Record the procedure on the SF 510.
  - a. Time.
  - b. Color, consistency and amount of drainage in suction canister.

**WARNING:** Changes in vital signs may suggest infection.

- c. Patient's tolerance of procedure.

*NOTE:* Continue to monitor the patient for signs of GI difficulties. Recurrence of nausea or vomiting may require reinsertion of NG tubing.

**Evaluation Preparation:**

Procedure should be evaluated on an actual patient needing removal of an NG tube. If one isn't available, a scenario can be presented to the Soldier and the Soldier can verbalize the steps required in removing an NG tube.

<b>Performance Measures</b>	GO	NO GO
1 Turned the patient's head to the side.	_____	_____
2 Put on disposable gloves.	_____	_____
3 Removed the tape from the patient's nose.	_____	_____
4 Instructed the patient to take a deep breath and hold it.	_____	_____
5 Clamped or pinch off the end of the tube to prevent release of gastric contents.	_____	_____
6 Removed the tube.	_____	_____
7 Disposed of soiled equipment in the container for contaminated waste IAW (in accordance with) infection control policy.	_____	_____
8 Removed soiled gloves.	_____	_____
9 Performed a patient care handwash.	_____	_____
10 Recorded the procedure on the SF 510.	_____	_____

**Evaluation Guidance:** Score each Soldier according to the performance measures in the evaluation guide. Unless otherwise stated in the task summary, the Soldier must pass all performance measures to be scored GO. If the Soldier fails any steps, show what was done wrong and how to do it correctly.

**References**

**Required**  
SF 510

**Related**  
None



## Place a Patient on a Cardiac Monitor

081-833-0167

**Conditions:** You have a conscious patient requiring continuous cardiac monitoring. You will need a cardiac monitor, leadwires, disposable pregelled electrodes (number of electrodes varies from three to five, depending on the monitoring system), 4 x 4 gauze pads, washcloth, alcohol pads, and SF 600 (Medical Record-Chronological Record of Medical Care). You have performed a patient care handwash and taken body substance isolation precautions (BSI). You are not in a CBRN environment.

**Standards:** Correctly connect the patient to the monitor without causing further harm.

### Performance Steps

1. Identify the patient.
  - a. Have the patient state their full name.
  - b. Have the patient state their date of birth.
  - c. Check the patient's wrist band, if one is available.
2. Explain procedure to the patient.
  - a. Provide privacy.
  - b. Ask the patient to expose their chest or expose patient if patient is unable to expose himself.
3. Prepare the equipment.

**NOTE:** Plug the cardiac monitor into an electrical outlet and turn it on to warm up the unit while you prepare the equipment and the patient, if not already done.

- a. Insert the cable into the appropriate socket in the monitor.
- b. Connect the leadwires to the cable, if necessary.
- c. Each leadwire should indicate the location for attachment to the patient.
  - (1) RA (right arm).
  - (2) LA (left arm).
  - (3) RL (right leg).
  - (4) LL (left leg).
  - (5) C or G (chest or ground).
- d. Check for the presence of recording paper and replace it as needed.
- e. Turn lead selection knob to the Lead II position, if so equipped.

**NOTE:** Positions are based upon which system and lead you are using.

4. Determine electrode positions on the patient's chest.
  - a. If necessary, clip the hair from an area about 4 inches (10cm) in diameter around each electrode site.
  - b. Clean the area with soap and water and dry.
  - c. An alcohol pad may be used to completely remove skin secretions that may interfere with electrode function.

*NOTE:* Gently abrade the dried areas by rubbing it briskly until it reddens to remove dead skin cells and to promote better electrical contact with living cells. Some electrodes have a small, rough patch for abrading the skin; otherwise, use a dry washcloth or a dry gauze pad.

5. Remove the backing from the pregelled electrode.

*NOTE:* Check the gel for moistness. If the gel is dry, discard electrode and replace with a fresh one.

6. Attach the leadwires to the electrodes.

7. Apply electrode to the site.

*NOTE:* Press firmly to ensure a tight seal.

a. Place the first electrode (RA) on the right anterior chest just below the right clavicle.

b. Place a second electrode (LA) on the left anterior chest just below the left clavicle.

c. Place a third electrode (C or G) at the fourth intercostal space; right sternal border.

d. Place the fourth electrode (RL) on the lower chest, just above and to the right of the umbilicus.

e. Place the fifth electrode (LL) on the lower chest, just above and to the left of the umbilicus.

f. When all electrodes are in place:

(1) Check for tracing on the cardiac monitor.

(2) Note the quality of the electrocardiogram (ECG).

(3) Verify that each beat is being detected by the monitor.

(a) Compare the digital heart rate display with your count of the patient's heart rate.

(b) If necessary, use the gain control to adjust the size of the rhythm tracing.

(c) Use the position control to adjust the waveform on the recording paper.

8. Set the upper and lower limits of the heart rate alarm.

*NOTE:* Turn the alarm on. The alarm should be set IAW unit policy or local SOP (standing operating procedure).

9. Document the procedure on a SF 600.

**Evaluation Preparation:**

Setup: For training and evaluation, use another Soldier to be the simulated patient.

Brief Soldier: Tell the Soldier the simulated patient needs to be placed on a cardiac monitor. Have the testing Soldier verbalize the steps as they are placing the patient on the cardiac monitor.

**Performance Measures**

1 Identified the patient.

GO NO GO

\_\_\_\_\_

2 Explained the procedure to the patient.

\_\_\_\_\_

3 Prepared the equipment.

\_\_\_\_\_

4 Determined electrode positions on the patient's chest.

\_\_\_\_\_

5 Removed the backing from the pregelled electrode.

\_\_\_\_\_

**Performance Measures**

	GO	NO GO
6 Attached the leadwires to the electrodes.	_____	_____
7 Applied electrode to the site.	_____	_____
8 Set the upper and lower limits of the heart rate alarm.	_____	_____
9 Documented the procedure on a SF 600.	_____	_____

**Evaluation Guidance:** Score each Soldier according to the performance measures. Unless otherwise stated in the task summary, the Soldier must pass all performance measures to be scored GO. If the Soldier fails any steps, show what was done wrong and how to do it correctly.

**References**

**Required**  
SF 600

**Related**  
Textbook of Basic Nursing

## Measure a Patient's Intake and Output

081-833-0006

**Conditions:** You have a patient requiring measurement of their intake and output. You will need a calibrated graduated container, gloves, common serving items, specimen collection container, urinal, bedpan, urinary drainage bag, nasogastric drainage container, pen, and DD Form 792 (Twenty-Four Hour Patient Intake and Output Worksheet). You are not in a CBRN environment.

**Standards:** Accurately measure and record the patient's fluid intake and output on appropriate forms.

### Performance Steps

1. Explain the procedure to the patient.
  - a. Inform the patient of the length of time during which the intake and output will be measured and the purpose of taking the measurements.
  - b. Tell the patient of any medical officer's order on fluid intake, such as forcing fluids or restricting the amount of intake.
2. Tell the patient what types of items require intake and/or output measurement.
  - a. Intake measurement.
    - (1) Items that are naturally fluid at room temperature such as jello, ice cream, ice, and infant cereals.
    - (2) Fluids consumed with and between meals, such as water, coffee, tea, broth, juice, milk, milk shakes, and carbonated beverages.
    - (3) IV infusion fluids, blood and blood products.
    - (4) Oral liquid medications.
    - (5) Irrigating solutions that are not returned.
  - b. Output measurement.
    - (1) Urine.
    - (2) Liquid stool.
    - (3) Vomitus.
    - (4) Drainage from wounds, chest tubes and suction devices.
3. Tell the patient to use specified containers such as a bedpan, specimen collection container or urinal to save all fluid output.
4. Measure the intake.
  - a. Calculate the oral fluid intake.

**NOTE:** Check the water pitcher at the beginning and end of each shift. Check the meal tray for the amount of liquids consumed before removing it from the room.

- (1) Note the type and size of the oral fluid containers.
- (2) Check the container to find the fluid capacity.
- (3) Check the "Equivalents Table" on DD Form 792.

*NOTE:* If an unmarked container is not listed on DD Form 792, fill it with water and pour its contents into a graduated container to check its capacity.

- b. Calculate the amount of IV solution or blood given.
- c. Calculate the amount of any irrigating solutions that are not returned, if applicable.
  - (1) Subtract the amount of solution returned from the known amount used for the irrigating procedure.
  - (2) Record the difference as intake.

5. Record, in cubic centimeters (cc), the fluid intake under the appropriate heading on DD Form 792.

*NOTE:* To convert ounces to cc, multiply the number of fluid ounces by 30. Example: 12 fluid ounces multiplied by 30 equals 360 cc. One millimeter (ml) is approximately equal to one cc.

- 6. Measure the output.
    - a. Put on gloves.
    - b. Record the level of output (urine, liquid, stool or emesis) in a graduated container.
- NOTE:* If it is not possible to weigh or measure liquid stool, estimate the amount IAW local SOP. Estimate the amount of solid stool IAW local SOP.
- c. Estimate the amount of wound drainage, if present, IAW local SOP.
  - d. Estimate any output not in a container, such as on the floor, skin or sheets, IAW with local SOP.

- e. Observe characteristics of the output.
  - (1) Color and odor of urine.
  - (2) Color, odor and consistency of stool.
  - (3) Color and consistency of nasogastric drainage.
- 7. Remove gloves and perform a patient care hand wash.
- 8. Record in cc the amount and characteristics of output under the appropriate headings on the DD Form 792.

*NOTE:* If no output was available to measure, enter this information in the "Remarks" section of the DD Form 792.

9. Compute accumulated intake and output totals at the end of the 24-hour period and record on the appropriate forms IAW local SOP.

### **Evaluation Preparation:**

Setup: If the performance of this task must be simulated for training and evaluation, premeasure at least two fluid items into common serving utensils. The Soldier will use them as the remains of a patient's simulated intake. You may also partially empty a bag or bottle of intravenous (IV) solution and have the Soldier calculate the amount of intravenous intake. Have at least two premeasured containers of simulated waste fluid to use for simulated output. Have the Soldier explain steps 1 through 3 to you.

Brief Soldier: Tell the Soldier to measure and record the intake and output of a specified patient.

<b>Performance Measures</b>	GO	NO GO
1 Explained procedure to patient.	_____	_____
2 Told the patient what types of items require intake and/or output measurement.	_____	_____
3 Told the patient to use specific containers such as a bedpan or urinal to save all fluid.	_____	_____
4 Measured intake.	_____	_____
5 Recorded, in cubic centimeters (cc), the fluid intake.	_____	_____
6 Measured the output.	_____	_____
7 Removed gloves and performed a patient care hand wash.	_____	_____
8 Recorded in cc, the amount and characteristics of output under the appropriate headings on the DD Form 792.	_____	_____
9 Computed accumulated intake and output totals at the end of the 24-hour period and recorded on the appropriate forms IAW local SOP.	_____	_____

**Evaluation Guidance:** Score each Soldier according to the performance measures. Unless otherwise stated in the task summary, the Soldier must pass all performance measures to be scored GO. If the Soldier fails any steps, show what was done wrong and how to do it correctly.

**References**

**Required**  
DD Form 792

**Related**  
None

## Perform a Gastric Lavage

**081-835-3005**

**Conditions:** You have a patient requiring gastric lavage. You will need an Ewald tube, nasogastric tubes, Y-connector, clamp or hemostat, water-soluble lubricant, 50 cc catheter-tip syringes, basins, IV pole, waterproof pads (chux), towels, sphygmomanometer, stethoscope, thermometer, graduated containers, ice, prescribed lavage solution, gloves, face shield, Yankauer or tonsil-tip suction device, suction apparatus, labeled specimen container, pen, 1 1/2 inches hypoallergenic tape, the patient's clinical record and a DD Form 1380 US Field Medical Card (FMC). You are not in a CBRN environment.

**Standards:** Perform the gastric lavage IAW the medical officer's orders and without causing further injury to the patient.

### Performance Steps

1. Assemble the necessary equipment and set it up at the patient's bedside.
  - a. Ensure that there is enough irrigating solution on hand.

*NOTE:* In most cases, the medical officer's order will be to lavage "until clear". Lavage will continue until the stomach contents return clear (nothing is returned but the irrigating solution itself). This requires preparation of at least 6 liters of the prescribed irrigating solution (usually normal saline).

- b. Ensure that ice or chilled solution is available when the medical officer orders "ice lavage".

*NOTE:* When lavage is done to control gastric bleeding, the order is usually for "ice lavage". Chilling the irrigating solution promotes vasoconstriction, thereby helping to control bleeding.

2. Explain the procedure to the patient.
3. Establish baseline vital signs.
4. Take body substance isolation precautions (BSI).
5. Position the patient.
  - a. A patient who is alert should be placed in the Fowler's or semi-Fowler's position.
  - b. A patient who is not alert, or too weak to sit, should be positioned on the left side, with the head of the bed elevated 15 degrees.

*NOTE:* This left lateral recumbent position will allow the tip of the tube to lie in the greater curvature of the stomach.

- c. Drape the towel or waterproof pad (chux) over the patient's chest.
  - d. If the patient wears dentures, remove them.
6. Insert the appropriate tube if one is not already in place.
  - a. For a stomach wash, the medical officer will specify insertion of large lumen nasogastric tube or the Ewald stomach tube.

*NOTE:* The Ewald stomach tube is normally inserted through the mouth rather than the nose, because it is a large bore tube. When the lavage tube passes the posterior pharynx, help the patient into a Trendelenburg position and turn him on his left side in a three-quarter prone posture.

b. For control of gastric bleeding, the medical officer will specify insertion of a large lumen nasogastric tube.

**CAUTION:** Gloves and eye protection should be worn for self-protection against transmission of contaminants, spills and splatters.

c. In the event of severe bleeding, as in the case of esophageal varices, the medical officer will specify insertion of a nasogastric tube that has gastric and esophageal balloons (Blakemore tube, for example).

*NOTE:* In any situation, a large lumen tube is indicated. Particles of food, mucous, or blood may occlude the lumen of a small tube.

7. Aspirate all stomach contents.

a. Using a 50 cc syringe, aspirate stomach contents and place the aspirate in a measured container.

b. Repeat until all stomach contents have been aspirated.

c. Record the total amount as output on the I&O worksheet.

d. Save the aspirate for disposition as directed by the medical officer.

8. Instill the irrigating solution, using the method specified by the medical officer's order or local SOP.

a. Syringe method. Using a 50 cc catheter-tip syringe, instill 100 cc of the solution. (Instillation and withdrawal are repeated 100 cc at a time, until clear or IAW medical officer's order).

**CAUTION:** When using the funnel method, it is imperative that the patient be carefully assessed for abdominal distention. The size and tolerance of the patient will determine how much fluid can be instilled at one time.

b. Funnel method. Using a funnel (or syringe barrel), instill up to 500 cc of the solution by pouring it slowly into the funnel.

9. Withdraw the irrigating solution.

a. Syringe method.

(1) Using a 50 cc catheter-tip syringe, withdraw all the irrigating solution and stomach contents.

(2) Place the aspirate into a measured container.

(3) Note the amount and character of the aspirate.

*NOTE:* If syringe aspiration is difficult, or no aspirate can be obtained, the gastric tube may be resting against the gastric mucosa. Reposition the patient and aspirate again. If aspiration is still difficult, reposition the tube by advancing or withdrawing it slightly.

b. Funnel method.

(1) Lower the funnel end of the tube below the level of the patient's stomach to facilitate gravity drainage.

*NOTE:* If the solution does not begin to drain by gravity, aspirate with a syringe (creating a siphon effect) to start the backflow of solution. If gravity drainage cannot be established, withdraw the solution by the syringe method.



- (2) Allow the irrigating solution and stomach contents to drain into a measured container.
- (3) Note the amount and character of the return solution.

10. Continue the lavage by repeating steps 7 and 8 IAW the medical officer's order. That is, continue until the stomach contents are clear, the prescribed amount of solution has been administered, or as otherwise directed.

- 11. Clamp the tubing.
  - a. Clamp and secure the tube if it is to remain in place.
  - b. Clamp and withdraw the tube if it is to be removed.

12. Remove all used equipment from the bedside.

- 13. Measure the lavage return.
  - a. Measure and record the total lavage return.
  - b. Estimate the amount of stomach contents by subtracting the known amount of irrigating solution used from the measured amount of total lavage return.
  - c. Record the amount of stomach contents as output on the I&O worksheet.

14. Dispose of the initial stomach aspirate and all lavage solution returned as directed by the medical officer's orders or local SOP.

- 15. Document the procedure and significant nursing observations on the appropriate forms IAW local SOP.
  - a. Note the type and amount of lavage solution used.
  - b. Note the color, odor, character, and amount of initial stomach contents aspirated.
  - c. Note the color, odor, character, and amount of lavage return.
  - d. Describe the patient's tolerance of the procedure.
  - e. Note the disposition of any specimens.

**Evaluation Preparation:** None.

<b>Performance Measures</b>	GO	NO GO
1 Assembled the equipment.	_____	_____
2 Explained the procedure to the patient.	_____	_____
3 Established baseline vital signs.	_____	_____
4 Took BSI precautions.	_____	_____
5 Positioned the patient.	_____	_____
6 Inserted the tube if necessary.	_____	_____
7 Aspirated all the stomach contents.	_____	_____
8 Instilled the irrigating solution.	_____	_____
9 Withdrew the irrigating solution.	_____	_____
10 Continued the lavage as directed by the medical officer's order.	_____	_____
11 Clamped the tubing.	_____	_____

<b>Performance Measures</b>	GO	NO GO
12 Removed the equipment.	_____	_____
13 Measured the lavage return.	_____	_____
14 Disposed of the initial aspirate and lavage return as directed by the medical officer's order.	_____	_____
15 Documented the procedure on FMC.	_____	_____

**Evaluation Guidance:** Score each Soldier according to the performance measures in the evaluation guide. Unless otherwise stated in the task summary, the Soldier must pass all performance measures to be scored GO. If the Soldier fails any step, show what was done wrong and how to do it correctly.

**References**

**Required**  
DD Form 1380

**Related**  
None

## Remove a Urinary Catheter

081-833-0197

**Conditions:** You have a medical officer's order for removal of an indwelling catheter. The patient has been draped for privacy. You will need gloves, 10 ml luer-lock syringe, paper towels, bedpan, waterproof pad (chux), and SF 600 (Medical Record-Chronological Record of Medical Care). You are not in a CBRN environment.

**Standards:** Remove a urinary catheter without violating aseptic technique or causing further injury to the patient.

### Performance Steps

1. Perform a patient care hand wash.
2. Assemble the equipment at the patient's bedside.
3. Explain the procedure to the patient.
  - a. Tell the patient he will feel slight discomfort.
  - b. Tell him that you will check him periodically during the first 6 to 24 hours after catheter removal to make sure he resumes voiding.
4. Put on gloves.

*NOTE:* Do not cut the catheter. The balloon may not deflate completely when cut.

5. Place chux pad underneath patient's buttocks.
6. Clamp the catheter.

*NOTE:* Damage to the urethra can occur if the balloon is not completely deflated.

7. Offer the patient the bedpan.
8. Remove the tape that attaches the catheter to the patient's leg.
9. Insert an empty 10 ml luer-lock syringe into the balloon port of the catheter.

*NOTE:* Do not cut the catheter. The balloon may not deflate completely when cut.

10. Pull back on the plunger of the syringe.
  - a. This deflates the balloon by aspirating the injected fluid.
  - b. Withdraw fluid from the balloon (usually 5 to 10 ml of fluid is in the balloon).

*NOTE:* The amount of fluid injected is usually indicated on the tip of the catheter's balloon lumen and in the patient's chart.

**WARNING:** Damage to the urethra can occur if the balloon is not completely deflated.

- c. Pull gently on the catheter to ensure that the balloon is deflated before attempting to remove it.
11. Hold a paper towel under the catheter with your non-dominant hand.
12. Grasp the catheter and pinch it with your thumb and index finger of your dominant hand to prevent urine from flowing back into the urethra.
13. Gently pull the catheter from the urethra, if there is no resistance.

*NOTE:* If you meet resistance, don't apply force; instead notify the medical officer.

14. Disconnect the catheter bag from the bed frame.

15. Measure the amount of urine in the collection bag before discarding it.

16. Dispose of the catheter and used equipment IAW local SOP for infectious waste and clean the area.

17. Dispose of the syringe by placing it in the sharps container and not in the trash container.

18. Remove and discard gloves and wash your hands.

**WARNING:** After catheter removal, assess the patient for incontinence (or dribbling), urgency, persistent dysuria or bladder spasms, fever, chills, or palpable bladder distention. The patient should void within 6 to 8 hours after catheter removal.

19. Document patient's tolerance of procedure and the amount of urine in bag on SF 600.

**NOTE:** For the first twenty-four hours after catheter removal, note the time and amount of each voiding.

a. Note the color of the urine.

b. Amount.

c. Odor if any detected.

d. Sediment formation in urine.

**Evaluation Preparation:** None.

**Performance Measures**

	GO	NO GO
1 Performed a patient care hand wash.	_____	_____
2 Assembled equipment at patient's bedside.	_____	_____
3 Explained the procedure to the patient.	_____	_____
4 Put on gloves.	_____	_____
5 Placed chux pad underneath patient's buttocks.	_____	_____
6 Clamped the catheter.	_____	_____
7 Offered bedpan to patient.	_____	_____
8 Removed the tape that attaches catheter to patient's leg.	_____	_____
9 Inserted an empty 10 ml luer-lock syringe into the balloon port of the catheter.	_____	_____
10 Pulled back on the plunger of the syringe.	_____	_____
11 Held a paper towel under the catheter with your non-dominant hand.	_____	_____
12 Grasped the catheter and pinched it with your thumb and index finger of your dominant hand to prevent urine from flowing back into the urethra.	_____	_____
13 Gently pulled the catheter from the urethra, if there is no resistance.	_____	_____
14 Disconnected the catheter bag from the bed frame.	_____	_____
15 Measured the amount of urine in the collection bag before discarding.	_____	_____
16 Disposed of the catheter and used equipment IAW local SOP.	_____	_____

<b>Performance Measures</b>	GO	NO GO
17 Disposed of the syringe by placing it in the sharps container and not in the trash container.	_____	_____
18 Removed and discarded gloves and washed hands.	_____	_____
19 Documented patient's tolerance of procedure and amount of urine in bag on SF 600.	_____	_____

**Evaluation Guidance:** Score each Soldier according to the performance measures. Unless otherwise stated in the task summary, the Soldier must pass all performance measures to be scored GO. If the Soldier fails any steps, show what was done wrong and how to do it correctly.

### References

**Required**  
SF 600

**Related**  
None

## Obtain an Electrocardiogram

081-835-3007

**Conditions:** You have a patient who requires an electrocardiogram (EKG). You will need an EKG machine, EKG recording paper, disposable pregelled electrodes, alcohol prep pads, 4 x 4 gauze pads, towels, tape, Optional Form (OF) 520 (Medical Record – Electrocardiographic Record), pen, SF 600 (Medical Record-Chronological Record of Medical Care), and optional equipment such as clippers, razor and a marking pen. You have performed a patient care hand wash, explained the procedure to the patient, taken body substance isolation precautions (BSI) and you are not in a CBRN environment.

**Standards:** Obtain an EKG in accordance with (IAW) the medical officer's order, local facilities standing operating procedures (SOP), without causing harm or injury to the patient.

**NOTE:** Confirm the patient's identity using two patient identifiers IAW local protocol.

### Performance Steps

1. Prepare the equipment.
  - a. Place the EKG machine close to the patient's bedside.
  - b. Read the manufacturer's instructions for the proper use of the equipment on hand.
  - c. Plug in the machine and turn it on.
  - d. Allow it to perform self-checks, if computerized, or warm up for 5 minutes if not computerized.

**NOTE:** If patient is already connected to a cardiac monitor, remove the electrodes to accommodate the precordial leads and minimize electrical interference, such as equipment, fixtures and power cords.

2. Prepare the patient.
  - a. Provide for the patient's privacy.
  - b. Ask patient about allergies to adhesive paste and gels.
  - c. Provide a female chaperone, if necessary, for female patients.
  - d. Provide a chest drape for female patients.
  - e. Ask or assist the patient to remove wristwatch, shoes, socks or hose, and all clothing from the waist up.
  - f. Ensure that the patient's body is not in contact with any metal objects, and that all limbs are firmly supported.

**NOTE:** Some metal objects, watches, or jewelry may interfere with the accurate recording of the electrical impulses.

**CAUTION:** If the bed or examination table is too narrow, place the patient's hands under their buttocks to prevent muscle tension. Also use this technique if the patient is shivering or trembling.

- g. Ask or assist the patient to lie supine on the bed or examination table.

**NOTE:** Patient's arms and legs should be relaxed to minimize muscle trembling, which can cause electrical interference. Make sure their feet are not touching the bed board.

3. Apply limb electrodes.
  - a. Select flat, fleshy areas to place the electrodes. Avoid muscular and bony areas.

*NOTE:* If the patient has an amputated limb, choose a site on the stump.

b. Clean the site for electrode placement by wiping with an alcohol prep pad to remove dead skin and oils as needed.

*NOTE:* An area of broken down or irritated skin should not be used for the electrode connection. If an area is excessively hairy, clip it.

c. Peel off the contact paper of the disposable electrodes.

(1) Check the gel for moistness.

(2) If gel is dry, discard electrode and replace with a fresh one.

(3) Apply electrodes directly to the prepared site.

*NOTE:* To guarantee the best connection to the leadwire, position disposable electrodes on the legs with the lead connection pointing superiorly.

d. Position the electrodes.

(1) Secure the leg electrodes on the medial or lateral aspect of the calf.

(2) Secure the arm electrodes on the arm or forearm, ensuring that the connections are not on, or adjacent to, an intravenous (IV) site.

(3) Connect the limb leadwires to the electrodes.

4. Apply the chest electrodes.

a. Expose the patient's chest.

b. If necessary, clip the hair from an area about 4 inches (10cm) in diameter around each electrode site.

c. Clean the sites for electrode placement by wiping with an alcohol prep pad to remove dead skin and oils as needed.

d. Position the electrodes, being careful to place them over the intercostal spaces and not directly over the ribs. (See Figure 3-8.)

*NOTE:* The standard EKG machine utilizes 12 "leads". these leads represent paths of electrical activity, and are designated as leads I, II, III, AVR, AVL, AVF, V1, V2, V3, V4, V5 and V6. Do not confuse these 12 leads with the 10 electrodes (sometimes referred to as "leads") that are attached to the patient.

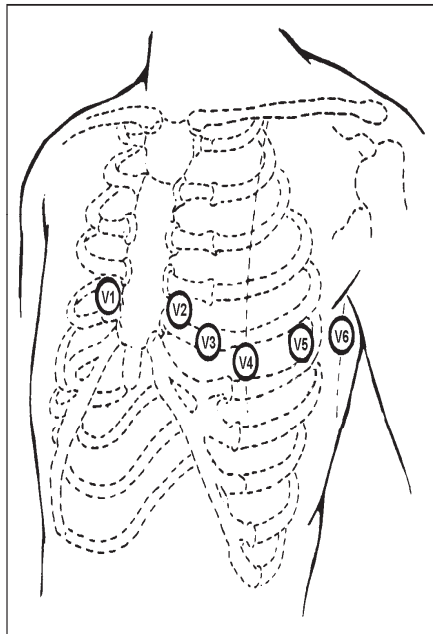

Figure 3-8. Position the electrodes

- (1) V1: 4th intercostal space at the right sternal border.
- (2) V2: 4th intercostal space at the left sternal border.
- (3) V3: Halfway between V2 and V4.
- (4) V4: 5th intercostal space at the left midclavicular line.
- (5) V5: 5th intercostal space at the left anterior axillary line.
- (6) V6: 5th intercostal space at the left midaxillary line.

e. Connect the chest leadwires to the electrodes.

**NOTE:** If your patient is a female, be sure to place the chest electrodes below the breast tissue. In a large-breasted female, you may need to displace the breast tissue laterally.

5. Obtain the EKG tracing.

**NOTE:** Check to see that the paper speed selector is set to the standard 25 mm/second and that the machine is set to full voltage.

a. Operate the equipment IAW the manufacturer's operating instructions.

b. The machine will record a normal standardization mark—a square that's the height of two large squares or 10 small squares on the recording paper.

**NOTE:** If any part of the waveform extends beyond the paper when you record the EKG strip, adjust the normal standardization to half-standardization. Be sure to note this adjustment of the EKG strip because this will need to be considered when interpreting the results.

c. Enter the appropriate patient identification data.

d. Ask the patient to relax and breathe normally.

**NOTE:** If a patient's respirations distort the recording, ask them to hold their breath briefly to reduce baseline wander in the tracing.

e. Tell the patient not to talk when you record their EKG.



**WARNING:** If the patient has a pacemaker, you can perform an EKG with or without a magnet according to the medical officer's order.

**CAUTION:** Be sure to note the presence of a pacemaker and the use of the magnet on the strip.

- f. Press the AUTO button and observe the tracing quality.
  - g. Ensure a complete and readable EKG tracing.
6. Observe and assess the EKG tracing as it is printed and take appropriate action.
- a. Observe the tracing for the presence of the normal waves in each heartbeat.

*NOTE:* Each heartbeat is normally represented as 5 major waves: P, Q, R, S, and T. The Q, R, and S waves all represent the same portion of the heartbeat and are referred to as a unit: QRS complex. Occasionally, a 6th wave will appear. It is referred to as the U wave. Although it does not always appear, its presence is perfectly normal. (See Figure 3-9.)

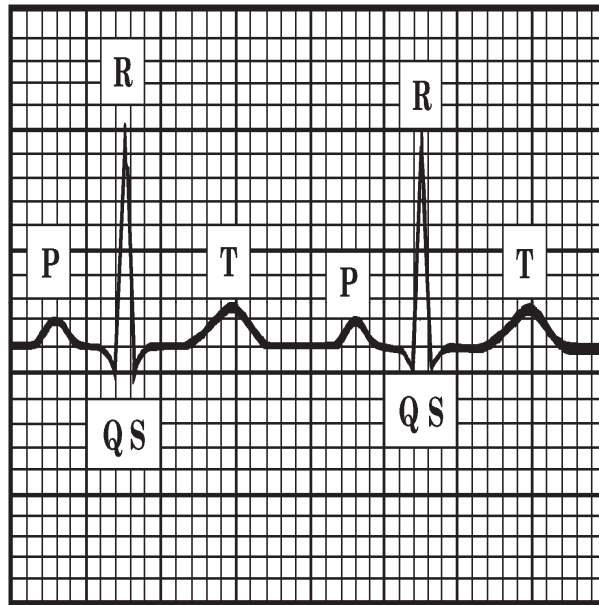

Figure 3-9. EKG tracing

b. Observe for irregularities that are a result of artifact, interference, or equipment malfunction.

- (1) Check the patient's position.
- (2) Check the placement of the electrodes.
- (3) Obtain new equipment if necessary.
- (4) Repeat the EKG.

c. Observe for irregularities of the heart's rhythm.

(1) Notify the medical officer IMMEDIATELY if you note the presence of any of the life-threatening ventricular arrhythmias.

*NOTE:* Ventricular arrhythmias are characterized by an ectopic (out of place) focus in the wall of the ventricle which initiates ventricular contraction. A distorted and prolonged QRS complex occurs as a result of the aberrant conduction pathway.

(a) Ventricular Fibrillation. V-Fib is an irregular and chaotic ventricular arrhythmia characterized by a rapid rate and disorganized conduction of impulses throughout the ventricular myocardium. Death will occur within minutes without immediate defibrillation or initiation of cardiopulmonary resuscitation (CPR). (See Figure 3-10.)

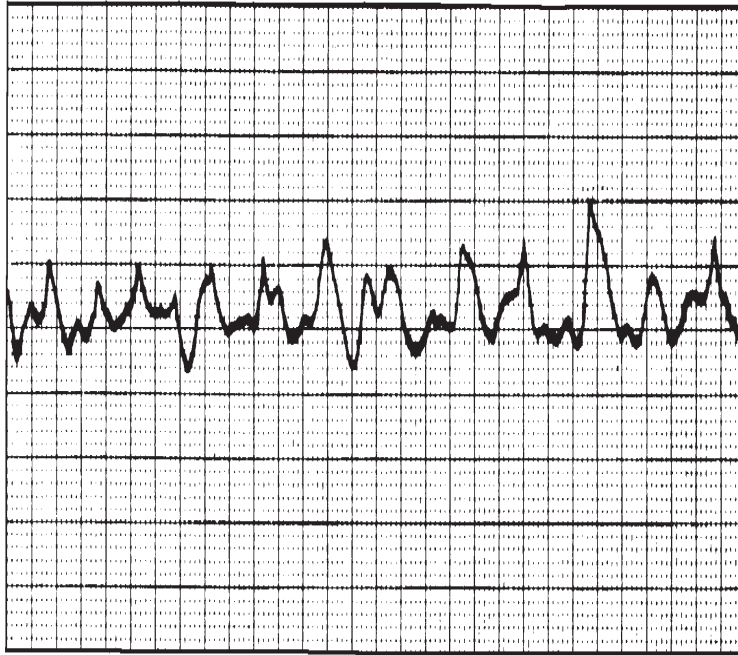

Figure 3-10. Ventricular fibrillation

(b) Ventricular Tachycardia. V-Tach is a ventricular arrhythmia characterized by broad QRS complexes and a regular rate that falls between 100 to 200 beats per minute. Immediate correction is essential, as V-Tach may lead to V-Fib. (See Figure 3-11.)

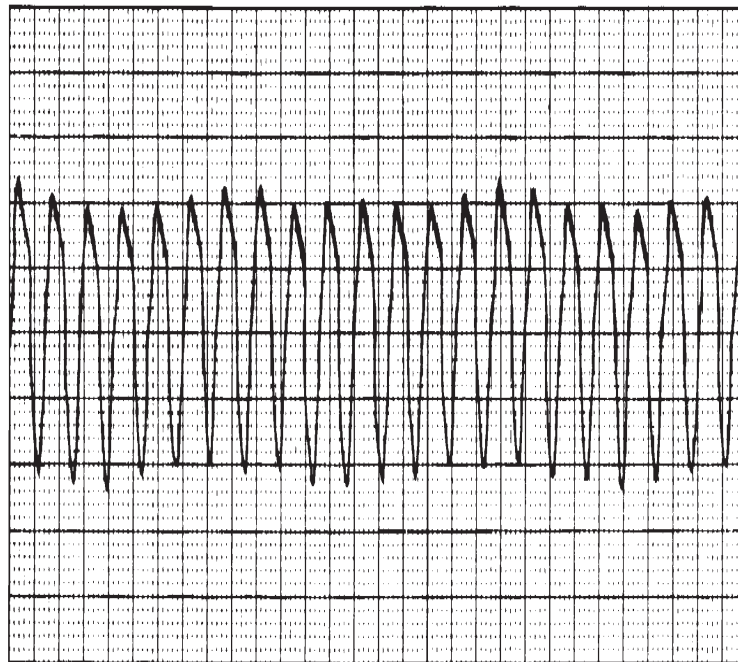

Figure 3-11. Ventricular tachycardia

(c) Premature Ventricular Contractions (PVCs). PVCs occur when an ectopic focus in one of the ventricles initiates contraction of the ventricles. When this occurs, there will be no atrial contraction associated with that beat, and no P wave will be seen in front of the QRS complex. A PVC usually has a tall, broad QRS complex. PVCs that come from different focal points in the ventricle will have different shapes on the EKG. PVCs may be harmless, but they may also be the forerunners of V-Tach and V-Fib. For this reason, even occasional PVCs should be considered important. PVCs are considered life threatening when they are frequent (more than 6 per minute), when they occur in groups of two or more (back-to-back), when they are multi-focal, and when they occur in a pattern of every other beat or every third beat (bigeminy, trigeminy). (See Figure 3-12.)



Figure 3-12. Premature ventricular contractions

(2) Notify the medical officer of any other irregularities of the heart's rhythm after you have completed the tracing, but before you remove the electrodes from the patient. (A second tracing may be ordered.)

7. Calculate the heart rate and report any abnormalities.

a. Time is measured on the horizontal axis of the EKG graph paper. (See Figure 3-13.)

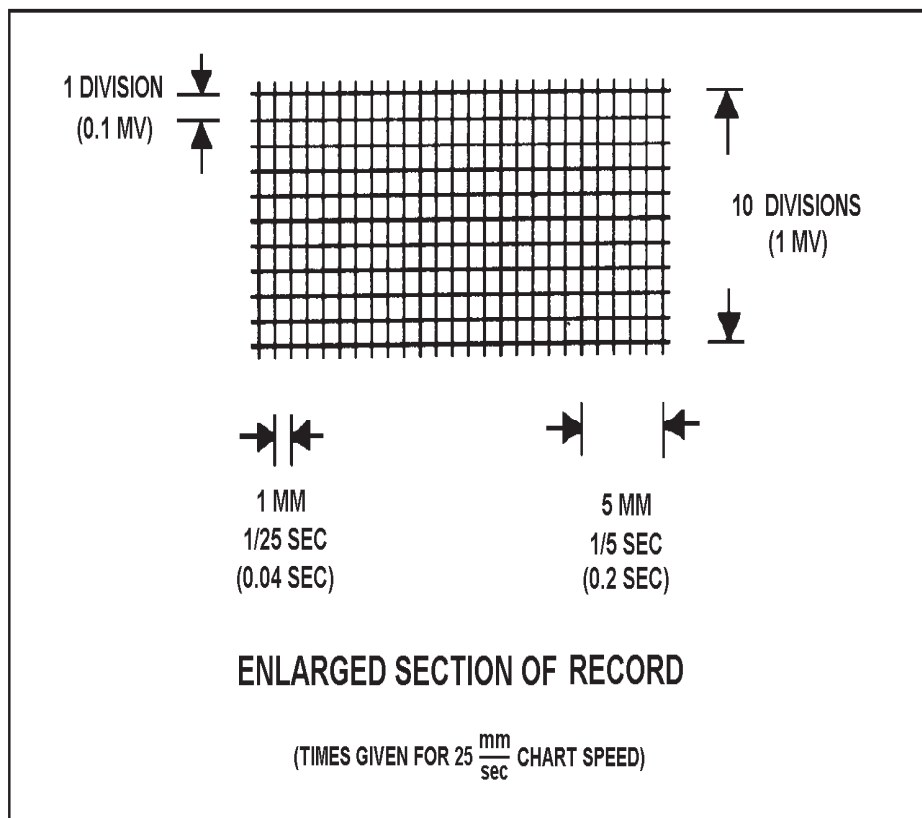

Figure 3-13. EKG graph paper

- (1) Each small box = 0.04 seconds.
  - (2) Each large box = 5 small boxes = 0.20 seconds.
  - (3) 5 large boxes = 1.0 second = 1 inch of graph paper.
  - (4) 300 large boxes = 60 seconds = 1 minute.
- b. Calculate the heart rate using one of the following methods:
- (1) Count the number of large boxes between any two R waves and divide that number into 300. Example: 300 divided by 5 large boxes = 60.
  - (2) Count the number of R waves in a 6 second strip and multiply by 10. Example: 6 R waves X 10 = 60.
- c. Notify the medical officer of irregularities.
- (1) Bradycardia-less than 60 beats per minute.
  - (2) Tachycardia-more than 100 beats per minute.
- NOTE:** Paper speed must be set on the normal (25 mm/sec) setting.
8. Remove the electrodes.
    - a. Remove all the chest and limb electrodes.
    - b. Wipe the patient's skin with a damp towel to remove the excess electrode paste.
- NOTE:** Instruct the patient to wash with soap and water as soon as convenient to avoid skin irritation from the EKG paste.
9. Ask or assist the patient to get dressed.

10. Prepare the report.
  - a. Remove the EKG tracing from the machine.
  - b. Mark the EKG tracing printout with the patient's identification.
  - c. Attach the completed OF 520 to the EKG tracing printout.
  - d. Make proper distribution of the report as directed by the medical officer's order or IAW local SOP.
11. Store the equipment.
  - a. Dispose of used electrodes IAW local SOP.
  - b. Restock the machine with EKG paper, electrodes, alcohol prep pads, towels, and drapes, as necessary.
  - c. Clean and store the machine in the area and manner directed by local policy.
12. Document the procedure and significant nursing observations on the SF 600 or appropriate forms IAW local SOP.

**Evaluation Preparation:**

This task must be performed with another Soldier serving as the patient and the Soldier being tested actually obtaining an EKG.

<b>Performance Measures</b>	GO	NO GO
1 Prepared the equipment.	_____	_____
2 Prepared the patient.	_____	_____
3 Applied the limb electrodes.	_____	_____
4 Applied the chest electrodes.	_____	_____
5 Obtained the EKG tracing.	_____	_____
6 Observed and assessed the EKG tracing.	_____	_____
7 Calculated the heart rate and reported any abnormalities.	_____	_____
8 Removed the electrodes.	_____	_____
9 Asked or assisted the patient to get dressed.	_____	_____
10 Prepared the report.	_____	_____
11 Stored the equipment.	_____	_____
12 Documented the procedure on SF 600.	_____	_____

**Evaluation Guidance:** Score each Soldier according to the performance measures. Unless otherwise stated in the task summary, the Soldier must pass all performance measures to be scored GO. If the Soldier fails any steps, show what was done wrong and how to do it correctly.

**References**

**Required**  
 OF 520  
 SF 600

**Related**  
 Textbook of Basic Nursing

## Perform Wound Irrigation

081-833-0012

**CAUTION:** All body fluids should be considered as potentially infectious so always observe body substance isolation (BSI) precautions by putting on clean gloves and an eye shield or face guard as a minimal standard of protection.

**Conditions:** You need to perform a wound irrigation. You will need waterproof pads (chux), irrigating syringe, examination gloves, sterile gloves, mask, prescribed irrigating solution, sterile dressing, catch basin, sterile gauze sponges, a sterile solution basin, and SF 600 (Medical Record- Chronological Record of Medical Care). You are not in a CBRN environment.

**Standards:** Perform a wound irrigation without violating aseptic techniques or causing further injury to the patient.

### Performance Steps

1. Identify the patient.
2. Explain the procedure to the patient.
3. Provide privacy, if possible, and position the patient at an angle that allows the irrigating solution to run from the upper end of the wound downward.
4. Place the waterproof protective pad and clean basin or irrigating pouch directly under the area to be irrigated.
5. Drape the patient with a bath blanket to expose only the wound.
6. Remove the used outer dressing and discard in a marked biohazard bag. Discard gloves and wash hands.
7. Prepare the irrigation equipment.
  - a. Open irrigation tray, using sterile technique, (establish a sterile field using the wrapper of the sterile solution basin).
  - b. Verify the prescribed irrigating solution.
  - c. Open the irrigation solution; place the cover on the table, with the inside facing upward.
  - d. Carefully pour the solution from the supply bottle into the irrigation bottle/syringe, pour solution with the bottle label facing your palm (if the bottle has been opened previously, pour off a small amount of the solution into a trash receptacle).
  - e. Leave the cover off of the irrigation supply bottle, with the inside of the cover pointing upward.
8. Put on a mask and eye protection.
9. Open the sterile dressing tray if one is to be used.
10. Put on sterile gloves. (See task 081-831-0008.)
11. Use sterile forceps to remove the inner dressings.
12. Carefully assess the amount and character of drainage, the size and condition of the wound and surrounding tissue.
13. Irrigate the wound.
  - a. Hold the syringe just above the wound's top edge without touching it, and force fluid into the wound, slowly and continuously.

- b. Use enough force to flush out debris, but do not squirt or splash fluid.
- c. Irrigate all portions of the wound (do not force solution into the wound's pockets).
- d. Continue irrigating until the solution draining from the wound's bottom end is clear.
- e. Repeat steps 13a and 13c until the wound is clear of debris and/or drainage.
- f. Observe the drainage for blood or characteristics such as unusual color, odor, or consistency.

*NOTE:* If signs of infection are observed, notify the medical officer immediately.

**CAUTION:** Use extra care when irrigating a wound in which an abscess has formed. Check all internal surfaces of the wound to inspect for "sinus tract" (resembles tunnels in which purulence or "pus" may be collected). This may require using the gloved hand or a sterile object to gently pull back the flesh. Be careful not to tear healing tissue.

14. Dry the wound and apply a sterile dressing.

a. Using sterile 4 x 4 pads, gently pat the wound's edges (unless the wound is to have a wet-to-dry dressing; then dry only the surrounding skin). Work from cleanest to most contaminated.

*NOTE:* Moving from clean to contaminated helps to prevent the spread of pathogens. If the wound is dry, the dressings will remain dry longer and contamination will not spread.

b. Apply a sterile dressing to the wound. (See task 081-833-0010.)

c. Remove the catch basin and waterproof pad (chux), if they are still in place.

15. Remove the mask, eye protection, and gloves.

16. Reposition the patient for comfort, if necessary.

17. Clean and store the equipment IAW local SOP.

18. Perform a patient care handwash. (See task 081-831-0007.)

19. Record the procedure on the SF 600.

20. Do not violate aseptic technique or cause further injury to the patient.

**Evaluation Preparation:**

Setup: If the performance of this task must be simulated for training or evaluation, have another Soldier act as the patient. Designate a wound site or use a moulage kit or similar material to simulate an injury. Prepare a medical officer's order specifying the type and amount of solution to be used.

Brief Soldier: Give the Soldier the medical officer's order and tell the Soldier to irrigate the wound. Tell the Soldier that they are not in a CBRN environment.

**Performance Measures**

	GO	NO GO
1 Identified the patient.	_____	_____
2 Explained the procedure to the patient.	_____	_____
3 Provided privacy, if possible, and positioned the patient at an angle that allowed the irrigating solution to run from the upper end of the wound downward.	_____	_____

<b>Performance Measures</b>	GO	NO GO
4 Placed a waterproof pad (chux) and clean basin or irrigating pouch directly under the area to be irrigated.	_____	_____
5 Draped the patient with a bath blanket to expose only the wound.	_____	_____
6 Removed the used outer dressing and discarded it in a marked biohazard bag.	_____	_____
7 Prepared the irrigation equipment.	_____	_____
8 Put on a mask and eye protection.	_____	_____
9 Opened sterile dressing tray.	_____	_____
10 Put on sterile gloves.	_____	_____
11 Used sterile forceps to remove the inner dressings.	_____	_____
12 Carefully assessed the amount and character of drainage, the size and condition of the wound and surrounding tissue.	_____	_____
13 Irrigated the wound.	_____	_____
14 Dried the wound and applied a sterile dressing.	_____	_____
15 Removed the mask, eye protection, and gloves.	_____	_____
16 Repositioned the patient for comfort, if necessary.	_____	_____
17 Cleaned and stored the equipment IAW local SOP.	_____	_____
18 Performed a patient care handwash.	_____	_____
19 Recorded the procedure on the SF 600.	_____	_____
20 Did not violate aseptic technique or cause further injury to the patient.	_____	_____

**Evaluation Guidance:** Score each Soldier according to the performance measures. Unless otherwise stated in the task summary, the Soldier must pass all performance measures to be scored GO. If the Soldier fails any steps, show what was done wrong and how to do it correctly.

**References**

**Required**  
SF 600

**Related**  
None



**Subject Area 13: Trauma Treatment****Prepare an Aid Bag****081-833-0194**

**Conditions:** You need to prepare an aid bag for an upcoming mission. The type and length of the mission are given to you. You will need airway, breathing, circulation and fracture supplies, antibiotics, pain medications, and a DD Form 1380 US Field Medical Card (FMC). You are not in a CBRN environment.

**Standards:** Prepare an aid bag with appropriate supplies for the mission.

**Performance Steps**

1. Determine the type of aid bag for mission required.

*NOTE:* The contents of the aid bag will be based on the type and length of the mission, and the skill level of the combat medic. There is no standard packing list for an aid bag.

- a. M-5 aid bag.
  - b. Blackhawk aid bag.
  - c. London Bridge aid bag.
  - d. Skedco aid bag.
  - e. Others.
2. Prepare aid bag (based on the skill level of individual medic).
    - a. Airway supplies.
      - (1) Nasopharyngeal airways.
      - (2) Oropharyngeal airways.
      - (3) Combitube® kit.
      - (4) Surgical cricothyroidotomy kit.
    - b. Breathing supplies.
      - (1) Vaseline gauze pads (occlusive dressing).
      - (2) HyFin chest seal.
      - (3) 14 gauge 3.25 inch needle catheter unit (for needle chest decompression).
    - c. Circulation supplies.
      - (1) Kerlix.
      - (2) Emergency bandages.
      - (3) Cravats.
      - (4) Combat application tourniquet (C-A-T).
      - (5) Intravenous (IV) Infusion sets.
      - (6) IV fluids.
      - (7) FAST 1 sternal intraosseous infusion device.
      - (8) Constricting band.

- (9) Alcohol pads.
- (10) Iodine pads.
- (11) Tegaderm® dressings.
- (12) 18 gauge intravenous (IV) catheters.
- (13) Saline locks.
- (14) Hemostatic bandages (chitosan).
- d. Fracture supplies.
  - (1) Sam splints.
  - (2) Ace wraps (2,4,6 inch).
- e. Antibiotics.
  - (1) Gatifloxacin® tablets 400mg.
  - (2) Cefotetan®, 2-g injection (IV antibiotics).
- f. Pain medications.
  - (1) Morphine tubex injectors 10 mg/ml.
  - (2) Toradol® 10 mg.
  - (3) Acetaminophen tablets 500mg.
- g. Miscellaneous supplies.
  - (1) Large abdominal pad.
  - (2) Tape nylon 1-2-3 inch size.
  - (3) Gauze pads 4 x 4 inch.
  - (4) Gauze pads 2 x 2 inch.
  - (5) Eye pads.
  - (6) Cotton tipped applicators.
  - (7) Band-aids.
  - (8) ENT kit.
  - (9) Stethoscope.
  - (10) Burn packs.
  - (11) Surgilube.
  - (12) Tincture of Benzoin®.
  - (13) Exam gloves.
  - (14) Adjustable c-collar.
  - (15) Field Medical Card.
  - (16) Bandage scissors.
  - (17) Needles (various sizes).
  - (18) Syringes (various sizes).

- (19) Chemlights.
- (20) Space blanket.
- (21) Oral hydration solution packs.
- (22) Tongue depressors.
- (23) Miscellaneous medications based on the medical officer's determination.

3. Verify aid bag is prepared appropriately.

**Evaluation Preparation:** A variety of Class VIII supplies should be available, along with the aid bag, for the Soldier to prepare. A mission scenario may be presented to the Soldier to evaluate how well they prepare the aid bag for that mission

<b>Performance Measures</b>	GO	NO GO
1 Determined the type of aid bag for mission required.	_____	_____
2 Prepared and packed aid bag appropriate for the mission.	_____	_____
3 Verified aid bag was prepared appropriately.	_____	_____

**Evaluation Guidance:** Score each Soldier according to the performance measures. Unless otherwise stated in the task summary, the Soldier must pass all performance measures to be scored GO. If the Soldier fails any steps, show what was done wrong and how to do it correctly.

**References**

**Required**  
DD Form 1380

**Related**  
None

## Subject Area 14: Venipuncture and IV Therapy

### Administer Medications by IV PiggyBack

081-835-3002

**Conditions:** You have a medical officer's orders requiring the administration of a medication by the intravenous (IV) piggyback route. You must prepare the piggyback unit. A patient care handwash has been performed. You will need medication, diluent, needle, syringe, alcohol (or other antiseptic) prep pads, label, container of IV solution, IV administration tubing, tape, DA Form 4678 (Therapeutic Documentation Care Plan (Medication)), and the patient's clinical record. You are not in a CBRN environment.

**Standards:** Prepare the IV piggyback unit without contamination and administer it to the patient without complications.

#### Performance Steps

1. Identify the patient, explain the procedure, and ask about allergies.
2. Check the DA Form 4678 against the medical officer's order.
  - a. Name of the medication.
  - b. Amount (dose) of medication.
  - c. Route of administration.
  - d. Time to be administered.
3. Select the medication.
  - a. Check the medication label three times to ensure that the correct medication is being prepared for administration.
  - b. Check the expiration date of the medication.
  - c. Handle only one medication at a time.

*NOTE:* If unfamiliar with a medication, look it up to determine contraindications, precautions, and side effects.

4. Prepare the medication.
  - a. Calculate the amount of medication required to equal the prescribed dose.

*NOTE:* If the medication is in powdered form, prepare it for use by adding the diluent specified on the drug information instructions.
  - b. Draw the prescribed amount of the prepared medication into a syringe.
  - c. Check the medication and calculations again to ensure that the correct medication and correct dose have been prepared.
5. Prepare the piggyback unit.

*NOTE:* Refer to the drug manufacturer's instructions to determine the type and amount of solution to be used as the piggyback unit.

- a. Use an alcohol prep pad to swab the injection port on the container of IV solution to be used as the piggyback unit.
- b. Inject the prepared medication into the container of IV solution.
- c. Mix the solution and medication into the container of IV solution.

- d. Label the piggyback unit with the name of the medication, the amount added, the time added, the date added, and the initials of the person who prepared the piggyback unit.
  - e. Dispose of the needle and syringe IAW local SOP.
6. Prime the piggyback infusion tubing.
    - a. Close the clamp on the piggyback tubing.
    - b. Aseptically insert the spike on the piggyback tubing into the solution port on the piggyback unit.
    - c. Squeeze the drip chamber to fill it half full.
    - d. Open the clamp on the piggyback tubing, allowing the solution to prime the tubing.
    - e. Close the clamp on the piggyback tubing when the solution reaches the end of the tubing.

**NOTE:** Attach a sterile needle to the end of the piggyback tubing if one is not provided by the manufacturer.

**CAUTION:** Take care not to waste any medicated IV solution while priming the tubing.

7. Connect the piggyback unit to the primary tubing.
  - a. Swab the injection port on the primary tubing with an alcohol prep pad.
  - b. Insert the needle into the injection port of the primary tubing.
  - c. Secure the connection with tape.

**NOTE:** Attach the piggyback tubing to the primary tubing below the level of the roller clamp. This will allow the piggyback unit to flow at its set rate without adjusting the flow rate of the primary solution.

8. Hang the piggyback unit on the IV pole, ensuring that the piggyback unit is at least 6 inches higher than the primary container.
9. Ensure patency of the primary IV.
10. Begin the secondary (piggyback) infusion.
  - a. Calculate the flow rate in accordance with the medical officer's order.

**NOTE:** If the medical officer does not specify a flow rate, set the flow rate IAW the drug manufacturer's instructions.

**CAUTION:** Do not adjust the flow rate of the primary container.

**NOTE:** When fluid from the secondary line enters the primary tubing, the primary infusion is automatically interrupted. When all the solution in the piggyback unit has been delivered, the primary infusion will resume flow at the set rate.

- b. Adjust the roller clamp on the piggyback tubing to regulate the flow rate of the piggyback solution.
11. Label the piggyback infusion tubing with the time and date the medication was initiated.
  12. Observe the patient for signs of infusion complications or reaction to the medicine. (See task 081-833-0034.)
  13. Document the procedure and significant nursing observations on the appropriate forms IAW local SOP.

**Evaluation Preparation:** None.

<b>Performance Measures</b>	GO	NO GO
1 Identified the patient, explained the procedure, and asked about allergies.	_____	_____
2 Checked the DA Form 4678 against the medical officer's order.	_____	_____
3 Selected the medication.	_____	_____
4 Prepared the medication.	_____	_____
5 Prepared the piggyback unit.	_____	_____
6 Primed the piggyback infusion tubing.	_____	_____
7 Connected the piggyback unit to the primary tubing.	_____	_____
8 Hung the piggyback unit on the IV pole, ensuring that the piggyback unit was at least 6 inches higher than the primary container.	_____	_____
9 Ensured patency of the primary IV.	_____	_____
10 Began the secondary (piggyback) infusion.	_____	_____
11 Labeled the piggyback infusion tubing with the time and date the medication was initiated.	_____	_____
12 Observed the patient for signs of infusion complications or reaction to the medicine.	_____	_____
13 Documented the procedure and significant nursing observations on the appropriate forms IAW local SOP.	_____	_____

**Evaluation Guidance:** Score each Soldier according to the performance measures. Unless otherwise stated in the task summary, the Soldier must pass all performance measures to be scored GO. If the Soldier fails any steps, show what was done wrong and how to do it correctly.

**References**

**Required**  
DA Form 4678

**Related**  
Textbook of Basic Nursing

## Operate an IV Infusion Pump

**081-833-0102**

**WARNING:** Pumps have various detectors and alarms that automatically signal or respond to the completion of an infusion, air in the line, low battery power, and occlusion or inability to deliver at the set rate. Depending on the problem, these devices may sound or flash an alarm, shut off or switch to keep vein open (KVO) rate.

**Conditions:** You have a patient requiring an intravenous (IV) infusion pump. You will need the patient's clinical records, a peristaltic pump, IV pole, IV solution, sterile administration set, sterile peristaltic tubing or cassette (if needed), alcohol pads, adhesive pads, adhesive tape, pen and SF 510 Nursing Notes . You have performed a patient care hand wash and are not in a CBRN environment.

**Standards:** Operate an IV infusion pump without causing further harm/injury to the patient IAW manufacturer's instructions and local SOP.

*NOTE:* Various types of IV pumps electronically regulate the flow of IV solutions or drugs with great accuracy. Volumetric pumps used for high pressure infusion of drugs or for highly accurate delivery of fluids or drugs, have mechanisms to propel the solution at the desired rate under pressure. The peristaltic pump applies pressure to the IV tubing to force the solution through it.

### Performance Steps

1. Attach the pump to the IV pole.
2. Swab the port on the IV container with alcohol.
  - a. Insert the administration set spike and fill the drip chamber completely to prevent air bubbles.
  - b. Prime the tubing and close the clamp.
  - c. Follow the manufacturer's instruction for placement of tubing.

*NOTE:* If your facility utilizes a bar code automated pump, scan your badge, the patient's ID (identification) bracelet, and the patient ID on the medication bag.

3. Position the pump on the same side of the bed as the IV or anticipated venipuncture site.

*NOTE:* If necessary, perform the venipuncture.

4. Plug in the machine.
5. Attach the tubing to the catheter hub.
6. Turn the machine on.
  - a. Press the START button.
  - b. Set the appropriate dials on the front panel to the desired infusion rate and volume.

*NOTE:* Always set the volume dial to 50ml less than the prescribed volume or 50ml less than the volume in the container so that you can hang a new container before the old one empties.

7. Confirm that the right information is displayed on the pump and push the RUN button.

*NOTE:* This can be verified by having a second person check the pump with you and the medical officer's order.

8. Check the patency of the IV line and watch for infiltration.

**NOTE:** Keep in mind that infiltration can develop rapidly with infusion by volumetric pump because the increased subcutaneous pressure will not slow the infusion rate until significant edema occurs.

9. Tape all connections.

10. Turn on the alarm switches.

**NOTE:** Explain the alarm system to the patient. This will prevent anxiety when a change in infusion activates the alarm.

**WARNING:** Check the manufacturer's recommendations before administering opaque fluids, such as blood, because some pumps fail to detect such fluids and others may cause hemolysis of infused blood.

11. Monitor the pump and the patient frequently.

**NOTE:** Monitoring frequently will ensure the device's correct operation, flow rate and rapid detection of infiltration and such complications such as infection and air embolism.

12. Record procedure on SF 510.

**Evaluation Preparation:** None.

<b>Performance Measures</b>	GO	NO GO
1. Attached the pump to the IV pole.	_____	_____
2. Swabbed the port on the IV container with alcohol.	_____	_____
3. Positioned the pump on the same side of the bed as the IV or anticipated venipuncture site.	_____	_____
4. Plugged in the machine.	_____	_____
5. Attached the tubing to the catheter hub.	_____	_____
6. Turned on the machine and pressed the START button.	_____	_____
7. Confirmed that the right information is displayed on the pump and pushed the RUN button.	_____	_____
8. Checked the patency of the IV line and watched for infiltration.	_____	_____
9. Taped all connections.	_____	_____
10. Turned on the alarm switches.	_____	_____
11. Monitored the pump and the patient frequently.	_____	_____
12. Recorded procedure on SF 510.	_____	_____

**Evaluation Guidance:** Score each Soldier according to the performance measures. Unless otherwise stated in the task summary, the Soldier must pass all performance measures to be scored GO. If the Soldier fails any step, show what was done wrong and how to do it correctly.

**References**

**Required**  
SF 510

**Related**  
None



**Remove a FAST 1****081-833-0238**

**Conditions:** You have a medical officer's order to discontinue (DC) a FAST 1. You will need disposable gloves, alcohol or povidone-iodine wipes, scissors, sterile 2 x 2 gauze, adhesive bandage, waterproof pad (chux), pen, puncture resistant (sharps) container, contaminated container for bloody waste and SF 510 Nursing Notes. You have verified the medical officer's order and the patient, performed a patient care hand wash and are not in a CBRN environment.

**Standards:** Remove the FAST 1 without causing further harm to or injury to the casualty.

**Performance Steps**

1. Put on body substance isolation (BSI) and personal protective equipment (PPE).
2. Remove the protector dome.

*NOTE:* Make sure one hand is holding the patch against the patient's skin while the other hand peels the Dome Velcro up so the patch does not come away from the skin during the process.

3. Turn off the source of fluid and medication.
  - a. Ensure that the clamp controlling the intravenous (IV) fluid flow is turned off.
  - b. Disconnect the IV line from the straight female connector tube on the patch.
  - c. Disconnect the infusion tube from the right-angle female connector on the patch.
4. Remove the infusion tube.
  - a. Place the patient in the same position as when the FAST 1 was inserted.

**CAUTION:** Use the tube to pull, not the luer connection.

b. Grasp infusion tube with fingers or clamp and pull perpendicular to the manubrium until entire infusion tube (including metal tip) emerges from the patient's chest.

*NOTE:* Pull in one continuous motion (do not start/stop) until removed. It is normal for the tubing to stretch.

5. Remove the target patch.
  - a. Gently peel the target patch away from the patient.
  - b. Discard the patch and infusion tube following local contaminated sharps protocol or in accordance with (IAW) local infection control guidelines.
6. Dress the infusion site.
  - a. Apply pressure to the infusion site.
  - b. Reasses to check bleeding from the site.
  - c. Dress the infusion site using aseptic technique.
7. Remove and discard BSI and PPE IAW local facility protocol.
8. Perform a patient care hand wash.
9. Record procedure on SF 510.

**Evaluation Preparation:**

Setup: For training and evaluation, use a simulation device capable of insertion and removal of the FAST 1.

<b>Performance Measures</b>	GO	NO GO
1 Put on BSI and PPE.	_____	_____
2 Removed the protector dome.	_____	_____
3 Turned off the source of fluid and medication.	_____	_____
4 Removed the infusion tubing.	_____	_____
5 Removed the target patch.	_____	_____
6 Dressed the infusion site.	_____	_____
7 Removed and discarded BSI and PPE IAW local facility protocol.	_____	_____
8 Performed a patient care hand wash.	_____	_____
9 Recorded procedure on SF 510.	_____	_____

**Evaluation Guidance:** Score each Soldier according to the performance measures. Unless otherwise stated in the task summary, the Soldier must pass all performance measures to be scored GO. If the Soldier fails any steps, show what was done wrong and how to do it correctly.

**References**

**Required**  
SF 510

**Related**  
None

**Subject Area 15: Primary Care**

**Provide Treatment for a Subungual Hematoma**

**081-833-0244**

**Conditions:** You have a patient requiring treatment for a subungual hematoma. You will need a No. 11 scalpel blade or a paper clip and a lighter. You are not in a CBRN environment.

**Standards:** Provide treatment for a subungual hematoma without causing further injury to the patient.

**Performance Steps**

1. Obtain a history of the patient's complaint.
2. Gather the materials for the procedure.
3. Perform a patient care handwash. (See task 081-831-0007.)
4. Put on gloves.
5. Explain the procedure to the patient.
6. Provide treatment for the subungual hematoma.
  - a. Scalpel blade. Place the tip of the scalpel blade on the nail and twist until blood drains.
  - b. Paper clip.
    - (1) Heat the paper clip until the tip is red-hot.
    - (2) Applying gentle pressure, puncture the nail with the hot paper clip and drain the blood.
7. Tell patient to soak the affected finger or toe in antibacterial soap and water twice a day for 2 to 3 days.
8. Record all treatment given.

**Evaluation Preparation:**

This task is best evaluated by verbalization of the steps. Give the Soldier a simulated patient and a scenario in which he must treat a patient's subungual hematoma.

<b>Performance Measures</b>	GO	NO GO
1 Obtained a history of the patient's complaint.	_____	_____
2 Gathered the materials for the procedure.	_____	_____
3 Performed a patient care handwash.	_____	_____
4 Put gloves on.	_____	_____
5 Explained the procedure to the patient.	_____	_____
6 Provided treatment for the subungual hematoma.	_____	_____
7 Told patient to soak the affected finger or toe in antibacterial soap and water twice a day for 2 to 3 days.	_____	_____
8 Recorded all treatment given.	_____	_____

**Evaluation Guidance:** Score each Soldier according to the performance measures. Unless otherwise stated in the task summary, the Soldier must pass all performance measures to be scored GO. If the Soldier fails any steps, show what was done wrong and how to do it correctly.

**References**

**Required**

None

**Related**

Emergency Medicine

## Operate a Glucometer

**081-833-0257**

**Conditions:** You have a patient requiring a blood glucose to be determined. You have the patient's clinical records, a portable blood glucose meter, blood glucose test strips, disposable gloves, disposable lancets or mechanical blood-letting devices, alcohol wipes, 2 x 2 gauze, pen, and SF 510 Nursing Notes. You have performed a patient care hand wash and you are not in a CBRN environment.

**Standards:** Operate a glucometer in accordance with (IAW) local standard operating procedures (SOP), and infection control guidelines, without causing harm to the patient.

*NOTE:* When using a blood glucose meter, calibrate it and run it with a quality control test to ensure accurate test results. Follow the manufacturer's instructions for calibration. If appropriate, ensure that the code strip number on the test strip matches the code number on the meter.

### Performance Steps

1. Confirm the patient's identity.
  - a. Ask the patient to state their full name.
  - b. Ask the patient their DOB (date of birth).
  - c. Check patient's wristband against clinical records.
2. Explain the procedure to the patient.
3. Select the puncture site (usually the fingertip or earlobe for an adult or a child).
4. Put on gloves.
5. Wipe the puncture site with an alcohol pad, and allow the site to dry completely.
6. Turn on the glucometer.

*NOTE:* The meter will indicate its readiness for testing blood glucose by message or symbol. Some meters require that the glucose strip be inserted at this time.

7. Collect sample from the fingertip with disposable lancet.
  - a. Position the lancet on the lateral side of the patient's fingertip perpendicular to the lines of the fingerprints.

*NOTE:* This avoids the most sensitive area of the fingertip.

- b. Pierce the skin sharply and quickly to minimize the patient's anxiety and pain and to increase blood flow.
- c. Alternatively, you can use a mechanical blood-letting device, which uses a spring-loaded lancet.
- d. Obtain a large, hanging drop of blood.

*NOTE:* After puncturing the fingertip, do not squeeze the puncture site, to avoid diluting the sample with tissue fluid. Some glucose meters require that the test area be covered completely for accurate results. Others use only a small drop of blood inserted at the side of the test strip.

- e. Apply a drop of blood to the test area of the test strip carefully.
- f. After collecting the blood sample, briefly apply pressure to the puncture site.

*NOTE:* Applying pressure will prevent painful extravasation of blood into the subcutaneous tissues. You may ask an adult to hold a gauze pad firmly over the puncture site until the

bleeding stops. After the bleeding has stopped, you may apply a small adhesive bandage to the puncture site.

8. Insert the test strip into the blood glucose meter according to the manufacturer’s instructions.

**WARNING:** If you get an extremely low or high blood glucose reading, immediately notify the medical officer and obtain a serum blood glucose level to confirm the result.

9. Read the digital display when the alarm sounds.

*NOTE:* Processing time varies between meters, but will be programmed to display result at the appropriate time.

10. Discard the lancet and test strip in sharps container, IAW facility’s policy and infection control guidelines.

11. Remove gloves and perform a hand wash.

12. Record the procedure and the patient’s response on SF 510.

**Evaluation Preparation:**

Setup: For training and evaluation, use another Soldier to determine their blood glucose level.

Brief Soldier: Tell the Soldier to determine the blood glucose level on the patient.

<b>Performance Measures</b>	<b>GO</b>	<b>NO GO</b>
1 Confirmed the patient's identity.	_____	_____
2 Explained the procedure to the patient.	_____	_____
3 Selected the puncture site (usually the fingertip or earlobe for an adult or a child).	_____	_____
4 Put on gloves.	_____	_____
5 Wiped the puncture site with an alcohol pad, and allow to dry completely.	_____	_____
6 Turned on the glucometer.	_____	_____
7 Collected sample from the fingertip with disposable lancet.	_____	_____
8 Inserted the test strip into the blood glucose meter according to the manufacturer’s instructions.	_____	_____
9 Read the digital display when the alarm sounds.	_____	_____
10 Discarded the lancet and test strip in sharps container, IAW facility’s policy and infection control guidelines.	_____	_____
11 Removed gloves and performed a hand wash.	_____	_____
12 Recorded the procedure and the patient’s response on SF 510.	_____	_____

**Evaluation Guidance:** Score each Soldier according to the performance measures in the evaluation guide. Unless otherwise stated in the task summary, the Soldier must pass all performance measures to be scored GO. If the Soldier fails any steps, show what was done wrong and how to do it correctly.

**References**

<b>Required</b>	<b>Related</b>
SF 510	Non

## Perform Patient Hygiene

**081-833-0165**

**Conditions:** A patient requires assistance with activities of daily living (ADL). You will need washcloths, towels, bath blanket or cover sheet, toiletry items (deodorant, powder, and other requested items), bedpan or urinal, clean hospital gown or pajamas, gloves, wash basin, clean bed linens, toothbrush or toothettes, emesis basin, suction equipment, water soluble lubricant, brush, comb, shampoo, lotion, razor, shaving cream, orange stick nail file, sheets, waterproof pads (chux), SF 600 (Medical Record-Chronological Record of Medical Care), pen, and dirty linen receptacle. You have performed a patient care hand wash and taken BSI (body substance isolation) precautions. You are not in a CBRN environment.

**Standards:** Perform patient hygiene without causing further injury to the patient.

### Performance Steps

1. Verify the activity with doctor's orders or nursing care plan.
2. Explain the procedure to the patient.

*NOTE:* Some of the following steps may be omitted based upon the patient's condition. Patients should be encouraged to participate in self care to the extent that they are able.

3. Provide a bed bath.
  - a. Provide privacy.
    - (1) Close the door and draw a curtain around the patient.
    - (2) Expose only the areas being bathed.
  - b. Raise the entire bed to comfortable working height.
  - c. Place the bath blanket or sheet over the patient and remove top covers without exposing the patient.
  - d. Remove the patient's gown.
    - (1) If the patient has an intravenous (IV) catheter in, remove the gown from the arm without the IV first. Move the IV bag and the tubing through the sleeve and re-hang the bag.
 

*NOTE:* If an IV pump is used, turn off the pump, clamp the tube, and then remove it as described above. Unclamp the tube, reinsert it into the pump, turn on the pump, and adjust the rate.
    - (2) If the patient has an injured extremity, remove the sleeve from the unaffected side first.
  - e. Place a towel under the patient's head.
  - f. Wash the face.
    - (1) Wash the patient's eyes from inner to outer canthus, using a clean part of the cloth for each eye.

*NOTE:* If the patient is unconscious, clean the eyes as above. Instill prescribed eye drops or ointment, if applicable. (See task 081-833-0015.) If the patient does not have a blink reflex, keep the eyelids closed and cover with a patch. Do not tape the eyelid.

(2) Wash, rinse, and dry the forehead, cheeks, ears, nose, and neck with plain warm water.

*NOTE:* Soap tends to dry the face. Men may want to be shaved. (See step 5b).

- g. Wash the upper body.

- (1) Remove the bath blanket from over the arm. Place a towel under the arm.
- (2) Bathe the arm using long firm strokes from distal to proximal end.
- (3) Lift the arm above the head if possible and wash and dry the axilla completely.
- (4) Repeat steps 3f (1) through 3f (3) on other arm.
- (5) Apply powder or deodorant to the axilla if applicable.
- (6) Bathe and dry the chest.

*NOTE:* Take special care to wash the skin under a female's breasts. Lift the breasts upward if necessary. Clean and dry thoroughly.

h. Wash the lower body.

(1) Place a bath towel over the chest and abdomen. Fold the blanket down to just above the patient's pubic region.

(2) Wash, rinse, and dry the abdomen paying attention to the umbilicus and the skin folds of the abdomen and groin.

(3) Wash and dry the leg nearest you.

(a) Place a towel under the leg.

(b) Support the leg at the knee and place the foot flat on the bed.

*NOTE:* The patient's foot may be placed in the basin to soak while the leg is being washed. However, soaking feet is NOT recommended for patients with diabetes mellitus or peripheral vascular disease.

**CAUTION:** Avoid massaging the legs when the patient is at risk for thrombosis or emboli.

(c) Wash and dry the leg using long firm strokes. Wash from ankle to knee and then from knee to thigh.

(d) Wash and dry the foot completely.

(e) Move to the opposite side and repeat steps 3h (3)(a) through 3g (3)(d) for the other leg.

*NOTE:* Always raise the side rail for safety.

i. Change bath water and gloves.

j. Wash the perineum.

(1) Place the patient in a side lying position and keep the patient covered with a bath blanket as much as possible.

(2) Wash the buttocks and anus from front to back.

*NOTE:* If feces is present, wrap it in an waterproof pad (chux) fold and remove as much as possible with disposable wipes first. Use as many wash cloths as necessary to clean completely. Ensure to cleanse the gluteal folds.

(3) Dry the area and replace the waterproof pad (chux) with a clean one.

k. Wash the genitals.

(1) Female.

(a) Position the patient supine with a waterproof pad beneath the buttocks. Drape the patient with a bath blanket to maintain privacy.



(b) Wash the labia majora and then gently pull back the labia majora to wash the groin from perineum to rectum.

(c) Clean the pubic area from front to back.

*NOTE:* Clean around an indwelling catheter if applicable without pulling tension on it. Ensure the catheter is secured to the upper thigh or positioned over the thigh (not under it).

(2) Male.

(a) Gently grasp the penis. Retract the foreskin if uncircumcised.

(b) Wash the tip of the penis and urinary meatus cleansing away from the meatus. Use a circular motion.

(c) Clean the penile shaft, scrotum, and underlying folds.

(d) Rinse and dry.

l. Change bath water and gloves.

m. Wash the back.

(1) Place the patient on his side.

(2) Clean and dry the back from neck to buttocks using long firm strokes.

n. Apply lotion to the skin if needed.

o. Replace the gown.

4. Provide oral care.

a. Place the patient in a side-lying position with a towel under the chin. Have an emesis basin available.

b. Separate the upper and lower teeth.

*NOTE:* Oral suction must be available, especially if the patient has no gag reflex.

c. Clean the mouth using a toothbrush, moistened 4 x 4 gauze, or toothette with water. Ensure the tongue, roof of mouth, inside cheeks, and tooth surfaces have been cleaned.

*NOTE:* The toothbrush should be soft bristled. Angle the brush at 45 degrees to clean the teeth. Avoid using glycerin or lemon swabs.

d. Rinse with a clean toothette and water.

*NOTE:* Use as little water as possible to avoid aspiration.

e. Suction the oral cavity as secretions accumulate if the patient is unable to remove them.

f. Apply lip balm or water-soluble jelly to the lips.

5. Provide hair care.

a. Shampoo the hair.

(1) Place a towel and waterproof pad under the head.

(2) Comb or brush the patient's hair to release any tangles.

(3) Position the patient supine with a plastic trough under the head.

(4) Pour warm water over the head until completely wet.

*NOTE:* Protect the patient's face and eyes by placing a towel or washcloth over them. If hair is matted with blood, apply hydrogen peroxide to dissolve it, and then rinse with saline or water.

- (5) Apply shampoo and lather.
- (6) Massage gently starting at the hairline and working toward the back of the scalp.
- (7) Rinse the hair.
- (8) Apply conditioner if needed.
- (9) Dry the hair.
- (10) Complete styling of the hair as necessary.

*NOTE:* Braids may be helpful to prevent tangling of long hair.

b. Shave the beard.

- (1) Position the patient into a sitting position if possible. Place a towel over the chest.
- (2) Place a moist, warm washcloth over the patient's face.
- (3) Apply shaving cream.
- (4) While pulling the skin taut, angle the razor to 45 degrees. Shave in the direction of hair growth.

*NOTE:* Ask the patient to direct you on his usual technique.

- (5) Rinse and dry the face. Apply aftershave if patient desires.

6. Perform foot and nail care.

a. Using an orange stick, gently clean under the patient's nails.

**CAUTION:** Never cut the toenails. A patient with diabetes or hypertrophy should be referred to a podiatrist.

b. Clip the nails straight and even with the digits. File the nails to shape and smooth rough edges.

c. Push the cuticle back gently with an orange stick.

d. Apply lotion.

7. Change the patient's linen (make an occupied bed).

a. Raise the entire bed to a comfortable working height.

b. Lower the head of the bed, if tolerated by the patient.

c. Remove the bedspread or blanket. Leave a sheet covering the patient.

d. Roll the patient to a side-lying position on the far side of the bed.

e. Roll the bottom sheet, draw sheet, and waterproof pad (chux) toward the patient as far as possible.

f. Place a clean bottom sheet on the bed.

(1) The sheet may be fitted.

(2) Flat sheet. Center the sheet on the bed, and pull the bottom hem toward the foot of the bed. Open the sheet toward the patient. Tuck and miter the top under the head of the bed.

g. Place draw sheets or waterproof pads on the center of the bed. Fan-fold toward the patient.

- h. Cover the unoccupied side of bed with the linen. Tuck the draw sheet under the mattress.
  - i. Assist the patient to logroll over all the linen toward the other side of the bed.
  - j. Raise the bed rail on the side facing the patient. Go to the other side and lower the bed rail.
  - k. Remove soiled linens. Place them on the floor or in the hamper.
  - l. Pull clean linen toward you. Straighten the linen out.
  - m. Tuck and miter the corners.
  - n. Tuck in the draw sheet.
  - o. Straighten the waterproof pads.
  - p. Assist the patient to a supine position.
  - q. Place a clean top sheet and blanket over the patient.
  - r. Remove the original cover sheet.
  - s. Tuck the bottom of the covers under the mattress making a modified miter. Loosen the linen at the feet for comfort.
  - t. Change the patient's pillowcase.
8. Assist the patient to a position of comfort and place needed items within reach.
  9. Raise the side rails and lower the bed.
  10. Remove soiled supplies.
  11. Document what was performed and the patient's response. Inability to tolerate a procedure should be documented on SF 600.

**Evaluation Preparation:**

Setup: For training and evaluation, this task is best tested utilizing a hospitalized patient.

Brief Soldier: Tell the Soldier to perform patient hygiene while the evaluator grades him.

**Performance Measures**

	GO	NO GO
1 Verified the activity with doctor's orders or nursing care plan.	_____	_____
2 Explained the procedure to the patient.	_____	_____
3 Provided a bed bath.	_____	_____
4 Provided oral care.	_____	_____
5 Provided hair care.	_____	_____
6 Performed foot and nail care.	_____	_____
7 Changed the patient's linen.	_____	_____
8 Assisted the patient to a position of comfort and placed needed items within reach.	_____	_____
9 Raised the side rails and lowered the bed.	_____	_____
10 Removed soiled supplies IAW local SOP.	_____	_____

11 Documented the procedures and the patient's response on SF 600. \_\_\_\_\_

**Evaluation Guidance:** Score each Soldier according to the performance measures. Unless otherwise stated in the task summary, the Soldier must pass all performance measures to be scored GO. If the Soldier fails any steps, show what was done wrong and how to do it correctly.

**References**

**Required**  
SF 600

**Related**  
Textbook of Basic Nursing

## Obtain a Throat Culture

081-833-0248

**Conditions:** You have a patient that requires a throat culture. You will need the patient's clinical records, gloves, tongue blades, penlight, sterile cotton-tipped swabs, sterile culture tube with transport medium (or commercial collection kit), label(s), laboratory request form, SF 510 Nursing Notes and a laboratory biohazard transport bag. You have performed a patient care hand wash and are not in a CBRN environment.

**Standards:** Obtain a throat culture without causing injury to the patient.

### Performance Steps

1. Explain the procedure to the patient and provide privacy.

*NOTE:* Tell the patient that they may gag during the swabbing, but that the procedure will probably take less than one minute.

2. Instruct the patient to sit erect at the edge of the bed or in a chair, facing you.
3. Put on gloves.
4. Ask the patient to tilt their head back.
5. Instruct the patient to open their mouth.
6. Depress the patient's tongue with the tongue blade.

*NOTE:* If the patient starts to gag, withdraw the tongue blade and tell them to breathe deeply. After they relax, reinsert the tongue blade carefully.

7. Illuminate the patient's throat with the penlight to check for inflamed areas.

**WARNING:** Do not touch the tongue, cheeks or teeth as this will contaminate the specimen with oral bacteria.

8. Swab patient's tonsillar areas with a cotton-tipped swab from side to side to include any inflamed or purulent sites.

9. Withdraw the swab and immediately place it in the culture tube.

*NOTE:* If you are using a commercial kit, crush the ampule of culture medium at the bottom of the tube and then push the swab into the medium to keep the swab moist.

10. Remove and discard gloves.
11. Label the specimen.
  - a. Patient's name.
  - b. Date of birth.
  - c. Medical officer requesting culture.
  - d. Date.
  - e. Time.
  - f. Site of collection.
12. Fill out laboratory request form appropriately.
13. Place culture in a laboratory biohazard transport bag.

14. Send or take the specimen to the laboratory immediately to prevent growth or deterioration of microbes.

15. Record procedure on SF 510.

**Evaluation Preparation:**

Setup: For training and evaluation, use another Soldier to act as the patient.

Brief Soldier: Tell the Soldier the patient requires a throat culture to be taken.

<b>Performance Measures</b>	GO	NO GO
1 Explained the procedure and provided privacy.	_____	_____
2 Instructed the patient to sit erect facing you.	_____	_____
3 Put on gloves.	_____	_____
4 Asked the patient to tilt their head back.	_____	_____
5 Instructed the patient to open their mouth.	_____	_____
6 Depressed the patient's tongue with the tongue blade.	_____	_____
7 Illuminated the patient's throat with the penlight to check for inflamed areas.	_____	_____
8 Swabbed patient's tonsillar areas with a cotton-tipped swab from side to side to include any inflamed or purulent areas.	_____	_____
9 Withdrew the swab and placed immediately in the culture tube.	_____	_____
10 Removed and discarded gloves.	_____	_____
11 Labeled the specimen correctly.	_____	_____
12 Filled out laboratory request form appropriately.	_____	_____
13 Placed culture in a laboratory biohazard transport bag.	_____	_____
14 Sent or took specimen to the laboratory immediately to prevent growth or deterioration of microbes.	_____	_____
15 Recorded procedure on SF 510.	_____	_____

**Evaluation Guidance:** Score each Soldier according to the performance measures. Unless otherwise stated in the task summary, the Soldier must pass all performance measures to be scored GO. If the Soldier fails any steps, show what was done wrong and how to do it correctly.

**References**

**Required**  
SF 510

**Related**  
None

## Test a Stool Sample

081-833-0256

**Conditions:** You have a patient stool sample requiring testing for occult blood. You will need the patient's clinical records, bedpan or specimen collection container, test kit, gloves, tongue blade or other wooden applicator, pen, and SF 600 (Medical Record-Chronological Record of Medical Care). You have performed a patient care hand wash and you are not in a CBRN environment.

**Standards:** Test a stool sample in accordance with (IAW) local infection control policy and standard operating procedures (SOP) without causing harm to the patient.

*NOTE:* Fecal occult blood tests are valuable for determining the presence of occult blood (hidden GI (gastrointestinal) bleeding) and for distinguishing true melena from melena-like stools. Certain medications, such as iron supplements and bismuth compounds, can darken stools so that they resemble melena. Occult blood tests are particularly important for early detection of colorectal cancer because 80% of patients with this disorder test positive.

### Performance Steps

1. Verify patient's identity according to your facility's policy.
  - a. Ask patient to state their full name.
  - b. Ask patient their date of birth.
2. Explain the procedure to the patient and check their history for medications that may interfere with the test.
  - a. If patient is ambulatory and has bathroom privileges (BRP) place a clean specimen collection container in toilet to obtain specimen.
  - b. Inform patient that specimen collection container is for stool specimen only not urine.
  - c. If patient is unable to use toilet or bedside commode, offer bedpan in order to obtain stool specimen.

*NOTE:* Inform patient to NOT place toilet tissue in bedpan with specimen and DO NOT urinate in bedpan with specimen. Tell patient to notify you when specimen is ready.

3. Put on gloves.

4. Collect stool sample.

*NOTE:* Do not collect routine samples during or until 3 days after a female's menstrual period to avoid a false-positive test from contamination of the specimen.

**CAUTION:** Make sure stool specimens are not contaminated with urine, soap solution, or toilet tissue, and test them as soon as possible after collection.

5. Test stool sample.

*NOTE:* Check the expiration date on the Hemoccult slides and developer, and protect the unused slides from heat, moisture, light, and chemicals.

a. Open the flap on the slide package.

(1) Use a wooden applicator to apply a thin smear of the stool specimen on the guaiac-impregnated filter paper exposed in box A.

(2) Apply a second smear from another part of the specimen to the filter paper exposed in box B.

(3) Allow the specimen to dry for 3 to 5 minutes.

b. Open the flap on the reverse side of the slide package.

(1) Place two drops of Hemocult developing solution on the paper over each smear.

(2) A blue reaction will appear in 30 to 60 seconds if the test is positive.

*NOTE:* Ingestion of 2 to 5 ml of blood, such as from bleeding gums or active bleeding from hemorrhoids, may produce a false positive.

6. Record the results and discard the slide package.

7. Remove and discard your gloves and wash your hands.

8. Document findings on an SF 600.

**Evaluation Preparation:**

Setup: For training and evaluation, this test is best verbalized.

Brief Soldier: Tell the Soldier to verbalize the steps to test a stool sample.

**Performance Measures**

	GO	NO GO
1 Verified patient's identity according to your facility's policy.	_____	_____
2 Explained the procedure to the patient and checked their history of medications that may interfere with the test.	_____	_____
3 Put on gloves.	_____	_____
4 Collected stool sample.	_____	_____
5 Tested the stool sample.	_____	_____
6 Recorded the results and discarded the slide package.	_____	_____
7 Removed and discarded gloves and washed hands.	_____	_____
8 Documented findings on an SF 600.	_____	_____

**Evaluation Guidance:** Score each Soldier according to the performance measures. Unless otherwise stated in the task summary, the Soldier must pass all performance measures to be scored GO. If the Soldier fails any steps, show what was done wrong and how to do it correctly.

**References**

**Required**  
SF 600

**Related**  
None



## Apply Flouri-Strip to an Eye

**081-833-0258**

**Conditions:** You have a medical officer’s order to apply a fluorescein stain to a patient’s eye to facilitate examination. You have verified the order and the patient. All other apparent life threats have been managed. You have the patient’s medical records, you have performed a patient care hand wash and taken appropriatebody substance isolation (BSI) precautions. You will need sterile fluorescein strips and illumination source, cotton applicators, sterile normal saline, waste receptacle, pen, and SF 600 (Medical Record-Chronological Record of Medical Care). You are not in a CBRN environment.

**Standards:** Apply flouri-strip to patient’s eye without causing injury.

### Performance Steps

1. Gather and assemble equipment.
2. Explain procedure to patient.
  - a. Place patient in a position of comfort.
  - b. Provide privacy for the patient.
3. Apply Flouri-strip to eye(s).
  - a. Gather one fluorescein strip to detect the foreign body and any corneal abrasion.

*NOTE:* Green stain will indicate if abrasion is present.

b. Apply a drop of saline to the strip; pull the lower eyelid down and gently touch the tip of the strip to the inner aspect of the eyelid.

*NOTE:* Moistening the strip will enhance the release of the dye.

c. Ask the patient to blink several times to distribute the dye.

*NOTE:* Dye will be dispersed over the conjunctive and cornea.

d. View cornea through a blue filter light to best inlluminate area of abrasion and foreign body.

*NOTE:* Breaks in the epithelium will cause aqueous humor to color the fluorescein dye green under the blue light.

4. Inform the medical officer that the patient is ready to be examined.
5. Discard used supplies and clean the area.
6. Remove BSI and perform a hand wash.
7. Document procedure on SF 600.

### Evaluation Preparation:

Setup: None.

Brief Soldier: Tell the Soldier that a patient requires fluorescein staining. Tell the Soldier to demonstrate/describe the procedure.

### Performance Measures

	GO	NO GO
1 Gathered and assembled all equipment.	_____	_____
2 Explained procedure to patient.	_____	_____
3 Applied flouri-strip dye to eye(s).	_____	_____

**Performance Measures**

	GO	NO GO
4 Informed medical officer that the patient is ready to be examined.	_____	_____
5 Discarded used supplies and cleaned area.	_____	_____
6 Removed BSI and performed a patient care hand wash.	_____	_____
7 Documented procedure on SF 600.	_____	_____

**Evaluation Guidance:** Score each Soldier according to the performance measures. Unless otherwise stated in the task summary, the Soldier must pass all performance measures to be scored GO. If the Soldier fails any steps, show what was done wrong and how to do it correctly.

**References**

**Required**  
SF 600

**Related**  
None

## Irrigate an Obstructed Ear

081-833-0059

**Conditions:** You have an order to irrigate an obstructed ear. You will need an irrigating syringe, catch basin, irrigating solution, towels, gauze sponges, and otoscope set. You are not in a CBRN environment.

**Standards:** Irrigate the obstructed ear until the obstructing material is removed from the external ear or until the prescribed amount of solution is used. Perform the procedure without causing further injury to the patient.

### Performance Steps

1. Gather the irrigation equipment.

*NOTE:* Common solutions used to irrigate the ear include water, normal saline, hydrogen peroxide and water, and prescribed medication solution. Alcohol may be used to shrink vegetable matter (associated with pediatric patients) and make it easier to expel. Oil or viscous lidocaine may be used for other foreign bodies to make them slippery.

2. Perform a patient care hand wash. (See task 081-831-0007.)

3. Warm and test the solution.
  - a. Warm the solution to about body temperature (95° F to 105° F) by placing the solution container in a container of warm water.

**CAUTION:** Cold solutions are not only uncomfortable but may cause dizziness or nausea as a result of stimulation of the equilibrium sensors in the semicircular canals.

- b. Test the temperature of the solution by running a small amount of it on the inner wrist.

4. Identify the patient and explain the procedure.
  - a. Tell the patient that some discomfort may be experienced when the solution is instilled.

**CAUTION:** If the patient moves when the solution is instilled, the syringe may damage the ear canal or tympanic membrane.

- b. Emphasize to the patient that he must remain as still as possible.

5. Insert the otoscope speculum into the external ear canal.
  - a. Position the patient to allow a good view into the ear.
  - b. Tilt the patient's head toward the shoulder opposite the ear to be irrigated.
  - c. Straighten the external ear canal by gently pulling the outer ear upward and backward for an adult or downward and backward for a child.

*NOTE:* Use the largest speculum that will fit comfortably in the patient's ear.

- d. Turn on the otoscope light and insert the speculum just inside the opening of the ear.

*NOTE:* To avoid causing pain, the speculum should be inserted gently and not too far into the ear canal.

- e. View the ear canal by looking through the lens of the otoscope.

6. Check for abnormalities.
  - a. Check the external ear canal for redness, swelling, drainage, or foreign bodies.
  - b. Check the tympanic membrane (TM) for any abnormal conditions.

**NOTE:** A normal eardrum is slightly cone-shaped, shiny, translucent, and pearly grey.

(1) A blue, yellow, amber, red, or pink eardrum indicates disease or infection.

(2) A bulge in the eardrum indicates possible pus or fluid in the middle ear.

**CAUTION:** If an abnormal condition of the TM is suspected, do not irrigate the ear. To do so could cause pain and carry debris or infectious discharge into the middle ear. Report the condition to the supervisor immediately.

(3) A hole or tear indicates rupture of the TM.

7. Position the patient sitting or lying with the head slightly tilted toward the affected side.

**NOTE:** Do not tilt the head toward the unaffected side, as this interferes with the return of the irrigating solution.

8. Drape the patient's shoulder and upper arm area under the affected ear.

**WARNING:** If a cotton-tipped applicator is used to clean the ear, make sure it does not stick far enough into the ear to rupture the TM.

9. Clean the external ear and the entrance to the ear canal with 4 x 4 gauze sponges slightly moistened with the irrigating solution.

10. Fill the irrigating syringe.

11. Test the flow of solution from the syringe by expelling a small amount back into the solution container.

12. Position the catch basin firmly against the neck just under the affected ear.

13. Straighten the external ear canal by gently pulling the outer ear upward and backward for an adult or downward and backward for a child.

14. Irrigate the patient's ear.

**WARNING:** Never allow the syringe to completely block the ear canal. If space is not left around the tip, the solution will not be able to return, and undue pressure will build up in the canal.

a. Place the tip of the irrigating syringe just inside the ear, with the tip directed toward the roof of the ear canal.

b. Depress the bulb or plunger of the syringe.

(1) Direct a slow, steady stream of solution against the roof of the ear canal.

(2) Repeat the procedure until the foreign body is removed, the solution returns free of wax or debris, or the proper amount of solution has been used.

15. Remove the catch basin and dry the external ear with a gauze sponge.

16. Instruct the patient to continue tilting the head toward the affected side for a few minutes to allow any remaining solution to drain from the ear.

17. Remove the drapes from the patient.

18. Dispose of, or clean and store, the equipment.

19. Perform a patient care handwash.

- 20. Document the procedure on the appropriate forms IAW local SOP.
  - a. Type and amount of solution used.
  - b. Nature of return flow.

21. Do not cause further injury to the patient.

**Evaluation Preparation:** None.

<b>Performance Measures</b>	GO	NO GO
1 Gathered the irrigation equipment.	_____	_____
2 Performed a patient care handwash.	_____	_____
3 Warmed and tested the solution.	_____	_____
4 Identified the patient and explained the procedure.	_____	_____
5 Inserted the otoscope speculum into the external ear canal.	_____	_____
6 Checked for abnormalities.	_____	_____
7 Positioned the patient.	_____	_____
8 Draped the patient's shoulder and upper arm area under the affected ear.	_____	_____
9 Cleaned the external ear and the entrance to the ear canal.	_____	_____
10 Filled the irrigating syringe.	_____	_____
11 Tested the flow of solution.	_____	_____
12 Positioned the catch basin.	_____	_____
13 Straightened the external ear canal.	_____	_____
14 Irrigated the patient's ear.	_____	_____
15 Removed the catch basin and dried the external ear.	_____	_____
16 Instructed the patient to continue tilting the head toward the affected side.	_____	_____
17 Removed the drapes from the patient.	_____	_____
18 Disposed of, or cleaned and stored, the equipment.	_____	_____
19 Performed a patient care handwash.	_____	_____
20 Documented the procedure on the appropriate forms IAW local SOP.	_____	_____
21 Did not cause further injury to the patient.	_____	_____

**Evaluation Guidance:** Score each Soldier according to the performance measures. Unless otherwise stated in the task summary, the Soldier must pass all performance measures to be scored GO. If the Soldier fails any steps, show what was done wrong and how to do it correctly.

**References**

**Required**  
None

**Related**  
None

## Utilize a Urine Test Strip

081-833-0255

**CAUTION:** Body substance isolation (BSI) precautions must be taken prior to handling of all body fluids. At a minimum gloves and eye protection should be worn.

**Conditions:** You have a patient requiring a dip urinalysis to be performed. You will need the patient's clinical records, SF 510 Nursing Notes, pen, bedpan, chux, disposable gloves, vial/bottle of urinalysis test strips, sterile urine collection container, antiseptic or liquid soap solution, sterile water, and a watch with a second hand. You have performed a patient care hand wash and are not in a CBRN environment.

**Standards:** Utilize a urine test strip and correctly interpret the results.

**NOTE:** For this task, ensure that the patient has been counseled and has provided a clean catch urine sample.

### Performance Steps

1. Gather equipment.
2. Put on disposable gloves.
3. Remove cap from reagent strip bottle and place on a clean dry surface upside down, using aseptic technique.
4. Remove one reagent strip from the bottle.
5. Replace the reagent strip bottle container cap immediately.

**NOTE:** This will minimize exposure of the remaining test strips to light and air.

6. Remove cap from container of urine specimen using aseptic technique.
7. Place cap from container of urine specimen upside down on a clean, dry surface using aseptic technique.
8. Immerse the reagent pads of the strip completely in the urine sample.
9. Remove immediately to avoid dissolving out the reagent pads.
10. Remove excess urine by running the edge of the strip against the rim of the specimen container.
11. Hold the strip in a horizontal position to prevent possible cross contamination of chemicals located in adjacent reagent pads.
12. Compare the color change of reagent pads to the corresponding color chart on the bottle label.
  - a. Read results according to the chart's time frame for each panel tested.

**NOTE:** As with all tests dealing with color intensity or color matching, it is often recommended to obtain another staff or co-worker's interpretation of the result.

- b. The closest color match indicates the test result.

**NOTE:** Further testing and consultation with a healthcare professional is necessary to confirm the presence of specific disease or health conditions.

13. Discard materials in accordance with (IAW) local facility standard operating procedures (SOP) and infection control guidelines.
  - a. Discard the reagent strip in the appropriate waste container.

b. Discard remainder of urine in the toilet or in designated waste container IAW local protocol.

c. Discard used specimen cup in appropriate waste container.

14. Remove and discard gloves.

15. Perform a patient care handwash.

16. Record the results of your findings on the SF 510.

**Evaluation Preparation:**

Setup: For training and evaluation, have Soldier verbalize the steps of utilizing the urine dip stick.

<b>Performance Measures</b>	GO	NO GO
1 Gathered equipment.	_____	_____
2 Put on disposable gloves.	_____	_____
3 Removed cap from reagent strip bottle and placed on a clean dry surface, upside down using aseptic technique.	_____	_____
4 Removed one reagent strip from the bottle.	_____	_____
5 Replaced the reagent strip container immediately.	_____	_____
6 Removed cap from urine specimen cup using aseptic technique.	_____	_____
7 Placed cap from specimen cup upside down, on a clean dry surface using aseptic technique.	_____	_____
8 Immersed the reagent pads of the strip completely in the urine sample.	_____	_____
9 Removed the strip immediately to avoid dissolving out the reagent pads.	_____	_____
10 Removed excess urine by running the strip along the edge of the specimen cup.	_____	_____
11 Held the strip in a horizontal position to prevent possible cross contamination of chemicals located in adjacent reagent pads.	_____	_____
12 Compared the color change of reagent pads to the corresponding color chart on the bottle label.	_____	_____
13 Discarded materials IAW local facility SOPs and infection control guidelines.	_____	_____
14 Removed and discarded disposable gloves.	_____	_____
15 Performed a patient care handwash.	_____	_____
16 Recorded results on the SF 510.	_____	_____

**Evaluation Guidance:** Score each Soldier according to the performance measures. Unless otherwise stated in the task summary, the Soldier must pass all performance measures to be scored GO. If the Soldier fails any steps, show what was done wrong and how to do it correctly.

**References**

**Required**  
SF 510

**Related**  
None

## Remove a Patient's Ring

**081-833-0195**

**Conditions:** You have a patient who requires a ring to be removed. You will need a Penrose drain, water-soluble lubricant, and a 25 inch length of umbilical tape or string, or thick silk suture. You are not in a CBRN environment.

**Standards:** Remove the patient's ring without causing further injury to the patient.

### Performance Steps

1. Lubricate the digit with a water-soluble lubricant and apply traction on the ring while turning in a circular motion.

*NOTE:* Frequently a ring must be removed to prevent laceration of tissue or vascular compromise.

2. Attempt to remove the ring using the string-wrap method.

a. Wrap the penrose drain circumferentially around the finger in a distal to proximal direction to reduce soft tissue swelling. For maximal effect, the wrap should stay in place for a few minutes.

b. A 20 to 25 inch piece of string, umbilical tape or thick silk suture is first passed between the ring and the finger. If there is marked soft tissue swelling, the tip of a hemostat may be passed under the ring to grasp the string and pull it through the ring.

c. The distal string is wrapped clockwise around the swollen finger (proximal to distal) to include the proximal interphalangeal (PIP) joint and the entire swollen finger.

(1) The wrapping is begun next to the ring and should be snug enough to compress the swollen tissue.

(2) The successive loops of the wrap are placed next to each other to keep any swollen tissue from bulging between the strands.

d. When the wrapping has been completed, the proximal end of the string is carefully unwound in the same clockwise direction, forcing the ring over that portion of the finger that has been compressed by the wrap.

3. If unsuccessful, a ring cutter should be used if there is excessive swelling.

a. The ring cutter has a small hook that fits under the ring and serves as a guide for a saw-toothed wheel that cuts the metal.

b. The cut ends of the ring are spread using large hemostats and the ring is removed.

4. Do not cause further injury to the patient.

**Evaluation Preparation:** None.

### Performance Measures

	GO	NO GO
1 Lubricated the digit with a water-soluble lubricant and applied traction on the ring while turning in a circular motion.	_____	_____
2 Attempted to remove the ring using the string-wrap method.	_____	_____
3 Attempted to remove the ring using a ring cutter.	_____	_____
4 Did not cause further injury to the patient.	_____	_____



**Evaluation Guidance:** Score each Soldier according to the performance measures. Unless otherwise stated in the task summary, the Soldier must pass all performance measures to be scored GO. If the Soldier fails any steps, show what was done wrong and how to do it correctly.

**References**

**Required**  
None

**Related**  
None

## Subject Area 16: CBRN

### Provide Treatment for a Blood Agent (Hydrogen Cyanide) Casualty in the Field

081-833-0276

**CAUTION:** Blood agent (hydrogen cyanide) causes symptoms ranging from convulsions to coma. After inhaling a high concentration of blood agent, a person may become unconscious and die within minutes. Blood agents in high concentration act quickly and death may result in 15 seconds. These agents release an odor of bitter almonds or peach kernels; however, approximately 50% of the population is genetically unable to detect the odor of cyanide. Anyone smelling the odors should mask immediately.

**Conditions:** You are in a chemical environment and have a casualty who is lying on the ground wearing protective overgarments, overboots, and mask carrier. You are wearing MOPP level 4. The casualty is displaying the signs and symptoms of blood agent poisoning. You will need ventilation equipment (if available), and DD Form 1380 US Field Medical Card (FMC).

**Standards:** Complete all the steps necessary to treat a blood agent casualty in the field, without causing further injury to the casualty.

#### Performance Steps

1. Check for signs and symptoms of blood agent poisoning.

*NOTE:* Cyanide causes very few signs and symptoms in man.

- a. Moderate, from low concentration.

- (1) Vertigo.
- (2) Nausea and vomiting.
- (3) Transient increase in rate and depth of breathing.
- (4) Headache.
- (5) Eye irritation.

*NOTE:* Above symptoms may progress to severe effects if exposure continues. The time of onset of these effects depends on the concentration, but is often within minutes after exposure.

- b. Severe, from high concentration.

- (1) Intense irritation of the eyes, nose, and airways.
- (2) Transient increase in rate and depth of breathing, after 15 seconds of exposure.
- (3) Violent convulsions after 30 seconds of exposure.
- (4) Respiratory arrest after 2 to 4 minutes of exposure.
- (5) Coma.
- (6) Cardiac arrest after 4 to 8 minutes of exposure.

2. Manage a casualty exposed to blood agents.

*NOTE:* Management of cyanide poisoning begins with self protection.

- a. Immediately mask and remove the casualty from the contaminated site.
- b. With liquid exposure, wet clothing should be removed.
- c. Skin should be washed with soap and water.

*NOTE:* A casualty that has ingested cyanide does not require decontamination.

**CAUTION:** No device currently exists that can provide medical assistance in a contaminated environment.

3. Administer positive pressure ventilation, if available.
4. Record the treatment given on the FMC.
5. Evacuate the casualty.

**Evaluation Preparation:**

Setup: Tell the Soldier to state the signs and symptoms of blood agent poisoning, and then treat the casualty.

Brief Soldier: Tell the Soldier to state the signs and symptoms of blood agent poisoning, and then treat the casualty.

<b>Performance Measures</b>	GO	NO GO
1 Checked for the signs and symptoms of blood agent poisoning.	_____	_____
2 Managed a casualty exposed to blood agents.	_____	_____
3 Administered positive pressure ventilation, if available.	_____	_____
4 Recorded the treatment given on the FMC.	_____	_____
5 Evacuated the casualty.	_____	_____

**Evaluation Guidance:** Score each Soldier according to the performance measures. Unless otherwise stated in the task summary, the Soldier must pass all performance measures to be scored GO. If the Soldier fails any steps, show what was done wrong and how to do it correctly.

**References**

**Required**  
DD Form 1380

**Related**  
FM 4-02.285

## **Provide Treatment for a Choking Agent Casualty in the Field**

**081-833-0277**

**Conditions:** You are in a chemical environment and have a casualty who is lying on the ground wearing protective overgarments, overboots, and mask carrier. You are wearing MOPP level 4. The casualty is displaying the signs and symptoms of a choking agent poisoning. You will need ventilation equipment (if available), and DD Form 1380 US Field Medical Card (FMC).

**Standards:** Complete all the steps necessary to treat a choking agent casualty in the field, without causing further injury to the casualty.

**NOTE:** The treatment available for the choking agent casualty in the field is limited. It is essential that the casualty be masked and evacuated to increase the possibility of survival.

### **Performance Steps**

1. Check for the signs and symptoms of choking agent poisoning.

a. Immediate signs and symptoms.

**NOTE:** Although heavy concentrations of poison bring on these symptoms very quickly, small doses may take up to 2 to 6 hours before there is any sign of poisoning.

(1) Eye pain, tearing, and transient blindness.

(2) Coughing and sneezing.

(3) Choking.

(4) Tightness in the chest or inability to breathe.

(5) Nose and throat irritation.

(6) Prolonged periods of vomiting.

(7) Headache.

(8) Feeling of malaise.

(9) Increased salivation.

(10) Burning sensation on exposed mucous membranes and skin.

(11) Erythema.

b. Delayed signs and symptoms.

(1) Rapid shallow breathing.

(2) Cyanosis.

(3) Apprehension.

(4) Severe coughing, producing frothy fluid.

(5) Weak and rapid pulse.

(6) Chest wall retractions.

(7) Pulmonary edema.

c. Asymptomatic. The casualty has been exposed, but shows no signs or symptoms.

2. Mask the casualty, but do not fasten the hood.

3. Position the casualty.

- a. Supine.
- b. Seated.

4. Treat the casualty.

*NOTE:* Most effects from exposure will disappear in 15 to 30 minutes, although erythema may persist for an hour or longer.

a. Asymptomatic.

(1) Restrict the casualty's activities to light duties to avoid stress to the respiratory system.

(2) Monitor the casualty for the onset of symptoms.

b. Symptomatic.

(1) Keep the casualty at rest (seated or supine).

(2) If the eyes are irritated they should be carefully flushed with water or saline.

(3) To remove agent from casualty's skin, wash with soap and water.

(4) Manage airway secretions.

*NOTE:* Provide intermittent positive pressure ventilation if needed and equipment is available.

(5) Keep the casualty warm.

5. Record the treatment given on the FMC.

6. Evacuate the casualty.

**Evaluation Preparation:**

Setup: For training and evaluation, have another Soldier act as the casualty and exhibit signs such as choking or coughing (coach the casualty on how to answer the Soldier's questions on symptoms such as headache). Tell the medic the casualty is exhibiting symptoms such as cyanosis. You may decide whether the casualty is already masked or not.

Brief Soldier: Tell the Soldier to state the signs and symptoms of a choking agent casualty, and then treat the casualty.

**Performance Measures**

- 1 Checked for signs and symptoms of choking agent poisoning.
- 2 Masked the casualty but did not fasten the hood.
- 3 Positioned the casualty.
- 4 Treated the casualty.
- 5 Recorded the treatment given on the FMC.
- 6 Evacuated the casualty.

GO	NO GO
_____	_____
_____	_____
_____	_____
_____	_____
_____	_____
_____	_____

**Evaluation Guidance:** Score each Soldier according to the performance measures. Unless otherwise stated in the task summary, the Soldier must pass all performance measures to be scored GO. If the Soldier fails any steps, show what was done wrong and how to do it correctly.

**References**

**Required**  
DD Form 1380

**Related**  
None

## Provide Treatment for a Radiation Casualty

081-833-0280

**Conditions:** You encounter a casualty with symptoms consistent with radiological exposure. You will need a fully stocked aid bag, intravenous (IV) administration equipment and fluids, oxygen, suction and ventilation equipment (if available), selected medications, documentation forms, and personal chemical protective equipment. You are in a CBRN environment.

**Standards:** Provide treatment for a radiation casualty.

### Performance Steps

1. Perform an assessment of the casualty to identify any conventional injuries. (See task 081-833-0155.)

*NOTE:* When assessing casualties during nuclear detonation and radiation injuries, it is important to realize that this is a multiple-casualty incident and should be approached from a triage perspective.

2. Recognize the course of radiation sickness on various systems in the body.

a. Hematopoietic (bone marrow and blood cells).

(1) Initial stage (occurs 1 hour to 2 days after exposure) - symptoms are anorexia, nausea, vomiting, fatigue, malaise, clotting disorders, and possible uncontrolled hemorrhage.

(2) Latent stage (lasts 1 to 6 weeks) - casualty may appear and feel well, although stem cells are dying.

b. Gastrointestinal (bowel).

(1) Initial stage (lasts about 2 days) - nausea and vomiting, loss of appetite, diarrhea, fluid loss, malaise and dehydration.

(2) Latent stage (lasts less than 1 week) - casualty may appear and feel well, although cells lining the GI are dying.

c. Cardiovascular (CV)/central nervous system (CNS).

(1) Initial stage (occurs within minutes of exposure and lasts for minutes to hours) - rapid onset of incapacitation, cardiovascular collapse, confusion, burning or "on fire" sensation with high doses.

(2) Latent stage (may last for hours) - casualty may return to partial functionality.

d. Skin - symptoms reddening (erythema).

*NOTE:* Duration of symptoms vary with the level of exposure; at low doses incapacitation should not be severe enough to warrant evacuation.

e. Affect on overall body during clinical phase.

*NOTE:* Symptoms frequently occur in the whole-body irradiated casualties within the first few hours of post exposure.

(1) Nausea and vomiting occur with increasing frequency as the radiation exceeds 100-200 centigrays (cGy).

(a) Onset may be as long as 6 to 12 hours post exposure.

(b) Vomiting within the first hours is associated with fatal doses.

(2) Hyperthermia.

(a) Significant rise in body temperature within the first few hours of potentially lethal radiation injury.

(b) Fever and chills are associated with severe and life-threatening radiation dose.

(3) Erythema.

*NOTE:* Developed within the first day of post exposure if casualty received a whole-body dose of more than 1000-2000 cGy. Erythema is restricted to the affected area.

(4) Hypotension.

(a) A noticeable decline in systemic blood pressure if received a lethal dose of whole-body radiation.

(b) Severe hypotension after irradiation is associated with a poor prognosis.

(5) Neurologic dysfunction.

(a) Almost all persons who demonstrate obvious signs of damage to the central nervous system within the first hours post exposure have received a lethal dose.

(b) Symptoms include mental confusion, seizures, and coma.

3. Treat conventional injuries first.
4. Remove the casualty's clothing. (See task 081-833-0095.)
5. Wash exposed body surfaces with soap and water. (See task 081-833-0095.)
6. Start an IV. (See task 081-833-0033.)
7. Administer antibiotics as appropriate.
8. Provide supportive care for the casualty depending on the situation.

*NOTE:* The amount of supplies required by radiation casualties can exceed the capabilities of small clinics. Consider the chance of survival of the casualty and the amount of supplies on hand when providing supportive care for the casualties.

**Evaluation Preparation:**

The task is best evaluated by performance of the steps. Give the Soldier a simulated casualty and a scenario in which he must manage casualties exposed to ionizing radiation.

<b>Performance Measures</b>	GO	NO GO
1 Performed a casualty assessment.	_____	_____
2 Recognized the course of radiation sickness on various systems in the body.	_____	_____
3 Treated conventional injuries first.	_____	_____
4 Removed the casualty's clothing.	_____	_____
5 Washed exposed body surfaces with soap and water.	_____	_____
6 Started an IV.	_____	_____
7 Administered antibiotics as appropriate.	_____	_____
8 Provided supportive care for the casualty depending on the situation.	_____	_____

**Evaluation Guidance:** Score each Soldier according to the performance measures. Unless otherwise stated in the task summary, the Soldier must pass all performance measures to be scored GO. If the Soldier fails any steps, show what was done wrong and how to do it correctly.

**References**

**Required**  
None

**Related**  
FM 4-02.285



## Provide Treatment for a Nerve Agent Casualty in the Field

**081-833-0275**

**Conditions:** You are in a chemical environment and have a casualty who is lying on the ground wearing a chemical protective overgarment and mask carrier. The casualty is displaying the signs and symptoms of nerve agent poisoning. You are wearing MOPP level 4. You will need a medical aid bag, MARK I nerve agent antidote kits (NAAK) or antidote treatment, nerve agent, autoinjectors (ATNAA) and convulsant antidote for nerve agents (CANA) autoinjectors, a DD Form 1380 US Field Medical Card (FMC), and decontamination litter. You are in a CBRN environment.

**Standards:** Complete all steps necessary to provide treatment for a nerve agent casualty in the field without causing further injury to the casualty.

### Performance Steps

1. Assess the casualty for the signs and symptoms of nerve agent poisoning.

*NOTE:* If the casualty has been exposed to vapor or aerosol, the pupils will become pinpointed immediately. However, if the nerve agent is absorbed through the skin only or by ingesting contaminated food or water, the pinpointing of the pupils may be delayed or absent.

- a. Vapor exposure.

*NOTE:* Effects from vapor exposure will occur within seconds to minutes after being exposed. Some of the respiratory distress from a mild exposure will spontaneously decrease within 15 to 30 minutes after termination of exposure.

- (1) Mild (small exposure).

*NOTE:* Exposure to small amounts of vapor for a brief period usually causes effects in the eyes, nose, and lungs.

- (a) Unexplained runny nose.
- (b) Unexplained sudden headache.
- (c) Sudden and excessive salivation (drooling).
- (d) Difficulty in seeing (dimness of vision and miosis (constricted pupils)).
- (e) Tightness in the chest or difficulty in breathing.
- (f) Stomach cramps.
- (g) Nausea with or without vomiting.
- (h) Tachycardia or bradycardia.

- (2) Severe (large exposure).

*NOTE:* Effects may occur after one breath but normally take place within several seconds of a large vapor exposure.

- (a) All or most of the mild and moderate symptoms.
- (b) Fatigue and weakness.
- (c) Red eyes with tearing.
- (d) Convulsions (severe muscular twitching).
- (e) Copious secretions from nose, mouth and lungs.
- (f) Strange or confused behavior.

- (g) Wheezing, dyspnea, and coughing.
- (h) Severely pinpointed pupils.
- (i) Vomiting.
- (j) Involuntary urination and defecation.
- (k) Sudden loss of consciousness.
- (l) Respiratory failure.
- (m) Bradycardia.
- (n) Flaccid paralysis.

b. Skin (percutaneous) exposure.

*NOTES:* 1. It is difficult to separate this type of exposure into categories due to the continued absorption of nerve agent into skin layers. Due to continued absorption, the effects from the nerve agent may be progressive in nature. They may occur from minutes up to 18 hours after exposure and continue even after the skin has been decontaminated. 2. The greater the amount of exposure to nerve agent, the shorter the onset time of symptoms with increased severity.

(1) Mild exposure.

- (a) Localized sweating at the exposure site.
- (b) Muscular twitching at the exposure site.
- (c) Stomach cramps, nausea and vomiting.
- (d) Fatigue.
- (e) Weakness.

(2) Severe exposure.

- (a) All or most of the mild symptoms.
- (b) Sudden loss of consciousness.
- (c) Vomiting.
- (d) Convulsions and severe muscle twitching.
- (e) Flaccid paralysis.
- (f) Loss of bladder and bowel control.
- (g) Severe breathing difficulty or cessation of respiration.

*NOTE:* Death would be the result of complete respiratory system failure.

2. Mask the casualty.

- a. Instruct the casualty to mask self if they are able.

**CAUTION:** Do not kneel or come into unnecessary contact with the chemically-contaminated ground.

- b. Position the casualty face up and mask the casualty. Do not fasten the hood at this time.

3. Check the casualty's pocket flaps and the area around the casualty for expended autoinjectors.

- 4. Administer the antidote.

*NOTE:* Atropine is the drug of choice for treating nerve agent poisoning.

a. Mild symptoms. Instruct the casualty to administer one to two MARK I kits or one ATNAA depending on the severity of symptoms, followed by observation for several long hours.

*NOTE:* ATNAA contains dual chambers, which administer 2.1mg atropine and 600mg Pralidoxime (2-pyridine aldoxime methyl chloride,) or 2-Pam CI sequentially through one needle.

b. Severe symptoms. Administer three MARK I Kits or ATNAA and one CANA (diazepam) auto-injector to the casualty.

*NOTE:* Removal of any liquid nerve agent on the skin, on clothing, or in the eyes should be accomplished as soon as possible after administration of the antidote. Decontamination should be performed by the casualty, if able, or by a buddy.

5. Check the casualty for signs of effectiveness of treatment.

*NOTE:* The casualty should be observed for at least several hours and not returned to duty. Liquid exposures can cause symptoms with onset delayed by many hours.

a. Atropinization.

(1) Heart rate above 90 beats per minute.

(2) Reduced bronchial secretions and bronchial constriction (patient breathes easily without excess secretions complicating breathing).

(3) Reduced salivation.

(4) Decreased gastrointestinal motility.

b. Cessation of convulsions.

6. Administer additional atropine or CANA, if needed.

a. After the administration of the three Mark I Kits, additional auto-injectors are not administered until an hour later.

b. Administer additional atropine (2mg) at approximately 5 minute intervals until atropinization is achieved.

c. A total of 15 to 20mg of atropine may be required in the first 3 hours after the onset of symptoms to maintain atropinization or until the casualty is evacuated to a medical treatment facility (MTF).

**CAUTION:** Do not give more than two additional CANA injections for a total of three.

d. Administer a second and, if needed, a third CANA at 5 to 10 minute intervals to casualties suffering convulsions.

*NOTE:* Additional atropine and the two additional CANA injections can be administered by a Combat Lifesaver (CLS), the Soldier Medic or other medical personnel (diazepam is not for self-use). Ensure all expended auto-injectors are secured to the casualty's left upper pocket of the army combat uniform (ACU) or the left pocket on the sleeve of the joint service lightweight integrated suit technology (JSLIST) over garment (which has no pockets on the upper torso portion of the garment).

7. Provide assisted ventilation for severely poisoned casualties, if equipment is available.

*NOTE:* The resuscitation device, individual chemical (RDIC) is a hand-powered ventilator equipped with a CBRN filter. When the casualty reaches an MTF where oxygen and a positive pressure ventilator are available, these should be employed continuously until adequate spontaneous respiration is resumed.

8. Record the number of injections given and all other treatment provided on the FMC.
9. Evacuate the casualty.
10. Do not cause further injury to the casualty.

**Evaluation Preparation:**

Setup: For training and evaluation, have another Soldier act as the casualty. Tell the casualty not to assist the Soldier in any way. This task must be performed in MOPP4.

<b>Performance Measures</b>	GO	NO GO
1 Assessed the casualty for the signs and symptoms of nerve agent poisoning.	_____	_____
2 Masked the casualty.	_____	_____
3 Checked the casualty's pocket flaps and the area around the casualty for expended autoinjectors.	_____	_____
4 Administered the antidote (MARK I Kits or ATNAA).	_____	_____
5 Checked the casualty for signs of effectiveness of treatment.	_____	_____
6 Administered additional atropine or CANA, if needed.	_____	_____
7 Provided assisted ventilation for severely poisoned casualties, if equipment was available.	_____	_____
8 Recorded the number of injections given and all other treatment given on the FMC.	_____	_____
9 Evacuated the casualty.	_____	_____
10 Did not cause further injury to the casualty.	_____	_____

**Evaluation Guidance:** Score each Soldier according to the performance measures. Unless otherwise stated in the task summary, the Soldier must pass all performance measures to be scored GO. If the Soldier fails any steps, show what was done wrong and how to do it correctly.

**References**

**Required**  
DD Form 1380

**Related**  
None

## **Provide Treatment for a Blister Agent Casualty (Mustard, Lewisite, Phosgene Oxime) in the Field**

**081-833-0278**

**Conditions:** You are in a chemical environment and are treating a casualty who is lying on the ground wearing MOPP level 4. You are wearing MOPP level 4. The casualty is displaying the signs and symptoms of blister agent poisoning. You must treat the casualty. You will need the casualty's canteen and personal decontamination kit, and DD Form 1380 US Field Medical Card (FMC). You are in a CBRN environment.

**Standards:** Complete all the steps necessary to treat a blister agent casualty in the field, without causing further injury to the casualty. Do not kneel when providing treatment.

### **Performance Steps**

1. Check for the signs and symptoms of blister agent poisoning (Mustard, Lewisite and Phosgene Oxime).

*NOTE:* Moist areas of the body are highly susceptible to blister agents. Therefore, during hot weather, blister agents can cause a greater number of casualties. Lewisite and Phosgene Oxime, in contrast to Mustard, causes immediate pain or irritation to the eyes, skin or respiratory tract.

a. Skin (onset delayed from 2-24 hours if contaminated by mustard (HD)).

- (1) Itching.
- (2) Erythema (redness).
- (3) Blisters.
- (4) Pain.

b. Eyes (L-immediate, HD-1 hour).

- (1) Mild exposure (onset delayed from 4-12 hours).
  - (a) Tearing.
  - (b) Gritty feeling.
  - (c) Itchy.
  - (d) Burning.
- (2) Moderate exposure (onset delayed from 3-6 hours).
  - (a) Swelling and blistering of eyelids.
  - (b) Erythema (redness).
  - (c) Moderate pain.
- (3) Severe exposure (onset delayed from 1-2 hours).
  - (a) Marked swelling of lids.
  - (b) Possible cornea damage.
  - (c) Severe pain.
  - (d) Permanent blindness (direct contact).

c. Respiratory tract (L-immediate, HD-4 to 6 hours).

(1) Mild (onset delayed from 12-24 hours).

(a) Runny nose.

(b) Sneezing.

(c) Nosebleed.

(d) Hoarseness.

(e) Hacking cough.

(2) Severe (onset delayed from 2-4 hours).

(a) Severe productive cough.

(b) Shortness of breath.

d. Systemic.

(1) Malaise.

(2) Headache.

(3) Nausea and vomiting.

(4) Severe skin burns.

**CAUTION:** Seek overhead protection, or heavy foliage if available.

(5) Bloody diarrhea.

**CAUTION:** While the eyes are being irrigated, the breath should be held and the mouth kept closed to prevent contamination and absorption through mucous membranes.

2. Tell the casualty to take a deep breath, hold it, and close the eyes.

3. Lift the casualty's mask.

4. Irrigate the casualty's eyes.

a. Use water from the casualty's canteen.

**NOTE:** If the casualty's water has been contaminated, use sterile water or sterile normal saline from the aid bag.

b. Tilt the casualty's head to one side.

c. Tell the casualty to open the eyes as much as possible.

d. Pour water slowly into one eye.

e. To avoid spreading contamination, let the water run off the side of the face.

f. Repeat steps 4a through 4e for the other eye.

**NOTE:** It may be necessary for the casualty to re-mask and take additional breaths if unable to hold the breath until both eyes are irrigated.

5. Use the casualty's personal decontamination kit on both the face and the portion of the mask in contact with the face and exposed skin. (See STP 21-1-SMCT, task 031-COM-1013.)

6. Replace the casualty's mask.

7. Tell the casualty to clear and check the mask.

8. Tell the casualty to breathe normally.

*NOTE:* Further decontamination procedures will be performed by the casualty (self-aid) or buddy aid.

9. Record the treatment given on the FMC.
10. Evacuate the casualty, if necessary.
11. Do not kneel at any time.

**Evaluation Preparation:**

Setup: For training and evaluation, have another Soldier act as the casualty and exhibit signs such as coughing. Coach the casualty on how to answer the Soldier's questions on symptoms such as headache. Tell the Soldier that the casualty is exhibiting signs such as blisters. Training decontamination kits must be used.

Brief Soldier: Tell the Soldier to state the signs and symptoms of blister agent poisoning, and then treat the casualty. For step 4, have the Soldier tell you what should be done.

<b>Performance Measures</b>	GO	NO GO
1 Checked for signs and symptoms of blister agent poisoning.	_____	_____
2 Told the casualty to take a deep breath, hold it, and close the eyes.	_____	_____
3 Lifted the casualty's mask.	_____	_____
4 Irrigated the casualty's eyes.	_____	_____
5 Used the casualty's personal decontamination kit on both the face and the portion of the mask in contact with the face.	_____	_____
6 Replaced the casualty's mask.	_____	_____
7 Told the casualty to clear and check the mask.	_____	_____
8 Told the casualty to breathe normally.	_____	_____
9 Recorded the treatment given on the FMC.	_____	_____
10 Evacuated the casualty, if necessary.	_____	_____
11 Did not kneel at any time.	_____	_____

**Evaluation Guidance:** Score each Soldier according to the performance measures. Unless otherwise stated in the task summary, the Soldier must pass all performance measures to be scored GO. If the Soldier fails any steps, show what was done wrong and how to do it correctly.

**References**

**Required**  
DD Form 1380

**Related**  
STP 21-1-SMCT

## Provide Treatment for a Biological Exposed Casualty

081-833-0279

**Conditions:** You encounter a casualty with symptoms consistent with biological agent exposure. All other life-threatening injuries have been treated. You will need a fully stocked aid bag, intravenous (IV) administration equipment and fluids, oxygen, suction and ventilation equipment (if available), selected medications, documentation forms, and chemical personal protective equipment. You are in a CBRN environment.

**Standards:** Perform appropriate identification and treatment for a casualty exposed to a biological agent.

### Performance Steps

1. Determine the biological warfare (BW) agent.

*NOTE:* Ensure personal protective equipment is available for yourself and the casualty.

*NOTE:* All scene size-up, initial assessment, focused history, examination, detailed physical examination, on-going assessment, and transport assessment steps must be taken to ensure that injuries or illnesses are not overlooked resulting in further injury to the casualty.

- a. Pneumonia-like agents.

- (1) Anthrax.

- (2) Tularemia.

- (3) Plague.

- (4) Q fever.

- b. Encephalitis-like agents.

- (1) Smallpox.

- (2) Venezuelan equine encephalitis.

- c. Biological toxins.

- (1) Botulinum.

- (2) Staphylococcal enterotoxin B.

- (3) Ricin.

- (4) Mycotoxins.

- d. Other agents.

- (1) Cholera.

- (2) Viral hemorrhagic fevers.

- (3) Brucellosis.

2. Recognize findings.

- a. Pneumonia-like agents.

- (1) Inhalational Anthrax (*Bacillus anthracis*).

- (a) Symptoms: Malaise, fatigue, myalgia, headache, dyspnea, shortness of breath and chest pain.

- (b) Signs: Fever, cough, tachypnea, hypotension, meningitis, stridor, diaphoresis, cyanosis, shock, and lesions if skin is exposed.

- (2) Plague (*Yersinia pestis*).



(a) Symptoms: Fever, chills, malaise, chest pain, swollen and painful lymph nodes called buboes, headache and meningitis.

(b) Signs: High fever, buboes, severe pneumonia, cough with hemoptysis, cyanosis, convulsions, shock, hemorrhagic skin changes and blackening of skin at extremities, disseminated intravascular coagulation (DIC), and septic shock.

(3) Tularemia (*Francisella tularensis*).

(a) Symptoms: Fever, chills, malaise, fatigue and substernal chest discomfort.

(b) Signs: Fever, tachycardia, tachypnea, non-productive cough, mucous membrane lesions, hypotension, prostration, sepsis and respiratory distress.

(4) Q fever (*Coxiella burnetti*).

(a) Symptoms: Severe headache, chills, myalgia and fatigue. Less common symptoms are nausea, vomiting, diarrhea, abdominal and chest pain.

(b) Signs: High fever, dry cough and sweats. Physical examination of chest is usually normal, but inspiratory rales may be present and consolidation may be seen on chest x-ray.

b. Encephalitis-like agents.

(1) Smallpox (*Variola major*).

(a) Symptoms: Malaise, rigors, headache and backache.

(b) Signs: Fever, vomiting, macular-papular rash that progresses to characteristic vesicular pustules, which become scabs and scars, prostration and delirium.

(2) Venezuelan equine encephalitis.

(a) Symptoms: Fever, severe headache, photophobia, myalgia and nausea.

(b) Signs: Chills, vomiting and sore throat.

c. Biological toxins.

(1) Botulinum.

(a) Symptoms: Generalized musculoskeletal weakness, diplopia, blurred vision and difficulty breathing.

(b) Signs: Generalized paralysis, ptosis, difficulty breathing and respiratory failure.

(2) Staphylococcal enterotoxin B.

(a) Symptoms: Headache, myalgia, and abrupt-onset abdominal pain.

(b) Signs: Fever, chills, non-productive cough, shock, vomiting, and diarrhea.

(3) Ricin.

(a) Symptoms: Weakness.

(b) Signs: Fever, cough and hypotension.

(4) T-2 mycotoxins.

(a) Symptoms: Nose and throat pain, itching, dizziness and chest pain.

(b) Signs: Redness, lesions on exposed skin, runny nose, sneezing, bloody vomiting, diarrhea and shock.

d. Other agents.

(1) Cholera.

- (a) Symptoms: Abdominal cramping, malaise.
- (b) Signs: Diarrhea, vomiting.
- (2) Brucellosis.
  - (a) Symptoms: Fever, malaise, myalgia, arthralgias and back pain.
  - (b) Signs: Profuse sweating, cough, malaise, chills, and weight loss.
- (3) Viral hemorrhagic fevers (VHF).
  - (a) Symptoms: Fever, myalgia, malaise, fatigue, prostration, headache and easy bleeding.
  - (b) Signs: Fever, conjunctival infection, petechiae, hypotension, flushing of face and chest, edema, vomiting, and diarrhea.
- (4) Glanders.
  - (a) Symptoms: Fever, myalgia, headache, and pleuritic chest pain.
  - (b) Signs: Rigors, sweats, cervical lymphadenopathy, hepatosplenomegaly, and generalized papular/pustular eruptions.
- 3. Terminate exposure. Physically remove the casualty from the contaminated environment.
- 4. Provide generalized emergency care.
  - a. Recognition and identification.
    - (1) Differentiate between chemical and biological weapons.
    - (2) Call for additional resources.
      - (a) Medical officers will be needed to prescribe proper antibiotic coverage and/or antitoxin treatment.
      - (b) Laboratory support will be needed for positive identification of the agent.
  - b. Isolation of selected cases.
    - (1) Smallpox, plague, and ebola are highly transmissible.
    - (2) Isolate biological casualties from unaffected individuals.
    - (3) Enforce protective measures.
  - c. Supportive care.
    - (1) Secure and maintain the airway. (See tasks 081-831-0018 and 081-833-0158.)
    - (2) Initiate IV fluid or saline locks.
  - d. Arrange for antibiotic or antitoxin therapy.
    - (1) Ciprofloxacin.
    - (2) Doxycycline.
    - (3) Gentamycin.
    - (4) Oral tetracycline.
    - (5) Erythromycin.
- 5. Treat for specific exposure.
  - a. Pneumonia-like agents.
    - (1) Anthrax.

- (a) Aggressive respiratory and cardiovascular support.
- (b) Intravenous fluids to counteract septic shock.
- (c) High dose intravenous antibiotics combined with oral ciprofloxacin or oral doxycycline.
- (d) Contact isolation is required.

(2) Plague.

*NOTE:* Early admission of antibiotics is critical, as pneumonic plague is invariably fatal if antibiotic therapy is delayed more than 1 day after the onset of symptoms.

- (a) Aggressive fluid resuscitation.
- (b) Parenteral streptomycin or gentamicin, with doxycycline or ciprofloxacin representing alternatives for 10-14 days.
- (c) Contact isolation is required.

(3) Tularemia.

- (a) Respiratory and fluid support as needed.
- (b) Administration of antibiotics (streptomycin or gentamycin) with early treatment is very effective for naturally acquired disease.
- (c) Contact isolation is required.

(4) Q Fever-oral tetracycline or doxycycline for 14 to 21 days.

*NOTE:* Q Fever may be a self-limited illness; however, the potential for severe complications and relapse warrant that all cases be treated.

b. Encephalitis-like agents.

*NOTE:* At present, there is no effective chemotherapy, and treatment of a clinical case remains supportive.

(1) Smallpox.

- (a) Respiratory and contact isolation.
- (b) Consider immediate vaccination.

(2) Venezuelan equine encephalitis.

- (a) Provide supportive treatment.
- (b) Blood and body fluid precautions required.
- (c) Investigational live, attenuated vaccine available.

c. Biological toxins.

(1) Botulinum.

(a) Early intravenous administration of trivalent licensed antitoxin or heptavalent antitoxin may prevent or decrease progression to respiratory failure.

(b) Intubation and ventilator assistance is needed for respiratory failure.

(2) Staphylococcal Enterotoxin B.

- (a) Provide respiratory support.
- (b) Initiate saline lock for vascular access.

(c) Hypochlorite solution effectively inactivates toxin when applied to most nonporous surfaces.

(3) Ricin.

(a) Management is supportive and should include treatment for pulmonary edema.

(b) Gastric lavage and cathartics are indicated for ingestion.

(c) Consider initiation of intravenous fluids.

(4) Mycotoxins.

(a) Thorough decontamination with hypochlorite solution.

(b) Provide respiratory support.

(c) Consider intravenous fluid.

(d) Superactivated charcoal should be given orally if the toxin is swallowed.

d. Other agents.

(1) Cholera.

(a) Aggressive rehydration with oral rehydration solution or IV ringers lactate.

(b) Intravenous normal saline.

(c) Antibiotic treatment with tetracycline or doxycycline 100mg by mouth (PO), twice a day (BID) for 3 days.

(d) Consider ciprofloxacin or erythromycin for resistant strains of cholera.

(e) Treat children with tetracycline, erythromycin, or trimethoprim-sulfamethoxazole.

(2) Brucellosis.

(a) Intravenous fluid initiation.

(b) Oral doxycycline combined with rifampin or streptomycin for 6 weeks.

(c) Endocarditis or other serious complication (hepatitis, splenitis, meningoenzephalitis or osteomyelitis) may require triple antibiotic coverage.

(3) Viral hemorrhagic fevers.

(a) Judicious use of intravenous fluids.

(b) Consider antiviral therapy with intravenous ribavirin.

(c) Consider immediate vaccination.

6. Triage casualties based upon level of exposure. (See task 081-833-0281.)

*NOTE:* Most BW casualties will be triaged as "Delayed" or "Minimal".

a. Minimal: all ambulatory casualties.

b. Delayed: moderate to severe symptoms.

c. Immediate.

(1) Respiratory failure.

(2) Decompensated shock.

d. Expectant.

- (1) Pulseless.
- (2) Persistent decompensated shock despite adequate IV fluids.
- 7. Provide protection for biological agents.
  - a. Recognition and identification of agent.
  - b. Personal protective equipment.
    - (1) Protective masks.
      - (a) Medical high-efficiency particulate air (high-efficiency particulate air (HEPA), occupational safety and health administration (OSHA) N95 mask).
      - (b) Self-contained breathing apparatus.
    - (2) Protective overgarment.
      - (a) Hood.
      - (b) Gloves.
      - (c) Boots.
  - c. Immunization and prophylaxis.
    - (1) Immunizations.
      - (a) Anthrax.
      - (b) Plague.
      - (c) Q fever (experimental).
      - (d) Tularemia.
      - (e) Smallpox.
      - (f) Venezuelan equine encephalitis (experimental).
      - (g) Viral hemorrhagic fevers (experimental).
      - (h) Botulinum.
    - (2) Prophylaxis.
      - (a) Anthrax: Oral ciprofloxacin or doxycycline.
      - (b) Plague: Doxycycline 100mg is given orally twice daily for 7 days, (alternative antibiotics: ciprofloxacin, tetracycline or chloramphenicol).
      - (c) Q fever: Tetracycline or doxycycline should be started 8-12 days post-exposure and continued for at least 5-7 days.
      - (d) Brucellosis: Doxycycline and rifampin prophylaxis.
      - (e) Tularemia: 2-week course of doxycycline or ciprofloxacin.

**Evaluation Preparation:** None.

<b>Performance Measures</b>	GO	NO GO
1 Determined the biological warfare agent.	_____	_____
2 Recognized findings.	_____	_____

- |   |  |       |       |
|---|--|-------|-------|
| 3 | Terminated exposure.                       | _____ | _____ |
| 4 | Provided generalized emergency care.       | _____ | _____ |
| 5 | Treated for specific emergency care.       | _____ | _____ |
| 6 | Triaged casualties.                        | _____ | _____ |
| 7 | Provided protection for biological agents. | _____ | _____ |

**Evaluation Guidance:** Score each Soldier according to the performance measures. Unless otherwise stated in the task summary, the Soldier must pass all performance measures to be scored GO. If the Soldier fails any steps, show what was done wrong and how to do it correctly.

**References**

**Required**

None

**Related**

None

## Subject Area 17: Triage and Evacuation

### Load Casualties onto Nonstandard Vehicles, 5 Ton M-1085, M-1093, 2 1/2 Ton M-1081

081-833-0173

**Conditions:** You have completed treating and triaging multiple casualties. You are in charge of loading litter casualties onto a nonstandard transport vehicle. You will need litters, and an M-1085, M-1093, or M-1081 vehicle. You are not in a CBRN environment.

**Standards:** Load litter casualties in accordance with (IAW) the proper loading sequence without causing further injury.

#### Performance Steps

1. Determine vehicle load capacities.
  - a. Long Wheelbase, 5-Ton, M-1085.
    - (1) 12 litter.
    - (2) 22 ambulatory.
  - b. Light Vehicle Air Drop/Air Delivery, 5 Ton, M-1093.
    - (1) 8 litters.
    - (2) 14 ambulatory.
  - c. Light Vehicle Air Drop/Air Delivery, 2 1/2 Ton, M-1081.
    - (1) 7 litters.
    - (2) 12 ambulatory.
2. Direct nonmedical Soldiers to load an M-1085. (See Figure 3-14.)

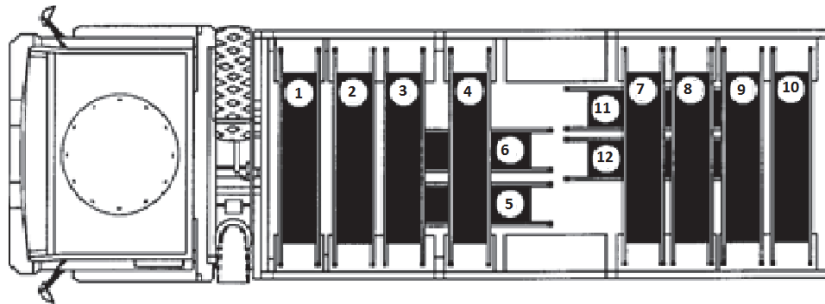

Figure 3-14. Load an M-1085

- a. Lower the seats and secure the vertical support brackets in place.
- b. Place four litters (litter numbers 1 through 4) crosswise on the seats, forward, next to the cab. Secure the litters individually to the seats.
- c. Place two litters (litter numbers 5 and 6) lengthwise on the floor, forward toward the cab, feet first, ensuring that casualty's' heads are exposed from under the upper litters. Secure the litters together and to the vertical seat supports.
- d. Place litter number 7 crosswise on the seats near the rear of the vehicle. Slide the litter as far forward as possible. Do not secure the litter at this time.
- e. Follow the same procedures in step 2d above for litter numbers 8 and 9.

f. Place litter number 10 crosswise on the furthest seat rearward. Secure the litter to the seat.

g. Slide litters (litter numbers 7, 8, and 9) rearward next to litter number 10. Secure the litters to the seats individually.

h. Place two litters lengthwise on the floor (litters 11 and 12), head first, ensuring that the casualty's head is exposed to the center opening, between the upper litters. Secure the litters together and to the vertical seat supports.

*NOTE:* The combat medic or combat lifesaver rides in the center of the vehicle to monitor the casualties. If the vehicle is loaded with the maximum number of casualties, the combat medic will not be able to attend to the casualties.

3. Direct nonmedical Soldiers to load an M-1093. (See Figure 3-15.)

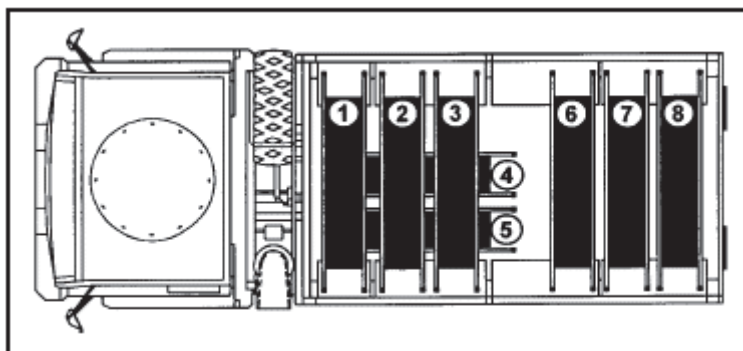

Figure 3-15. Load an M-1093

a. Lower the seats and secure the vertical support bracket into place.

b. Place three litters (litter numbers 1 through 3) crosswise on the seats, forward, next to the cab. Secure the litters individually to the seats.

c. Place two litters (litter numbers 4 and 5) lengthwise on the floor, forward toward the cab, feet first. Secure the litters together and to the vertical seat support.

d. Place litter number 6 crosswise on the seats near the rear of the vehicle. Slide the litter as far forward as possible. Do not secure the litter at this time.

e. Place litter number 7 crosswise on the seats near the rear of the vehicle and slide it forward as in step 3d above. Secure the litter to the seats.

f. Place litter number 8 crosswise on the seats as far rearward as possible. Secure the litter to the seats.

g. Glide litter numbers 6 and 7 rearward next to litter number 8. Secure the litters to the seats.

h. Raise and secure the tailgate.

*NOTE:* The combat medic or combat lifesaver rides in the center of the vehicle to monitor the casualties.

4. Direct nonmedical Soldiers to load an M-1081. (See Figure 3-16.)



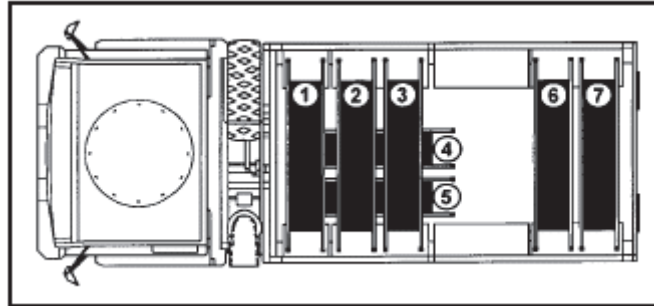

Figure 3-16. Load an M-1081

- a. Lower the seats and secure the vertical support bracket into place.
- b. Place three litters (litter numbers 1 through 3) crosswise on the seats, forward, next to the cab. Secure the litters individually to the seats.
- c. Place two litters (litter numbers 4 and 5) lengthwise on the floor, forward toward the cab, feet first. Secure the litters together and to the vertical seat support.
- d. Place litter number 6 crosswise on the seats near the rear of the vehicle. Slide the litter as far forward as possible. Do not secure the litter at this time.
- e. Place litter number 7 crosswise on the seats as far rearward as possible. Secure the litter to the seats.
- f. Slide litter number 6 rearward next to litter number 7. Secure the litter to the seats.
- g. Raise and secure the tailgate.

*NOTE:* The combat medic or combat lifesaver rides in the center of the vehicle to monitor the casualties.

**Evaluation Preparation:**

Setup: For training and evaluation, use other Soldiers as litter bearers and simulated casualties.

Brief Soldier: Tell the Soldier the simulated casualties require loading onto nonstandard vehicles. The Soldier will perform the task as the lead litter bearer and instruct the other litter bearers on the loading sequence of casualties.

**Performance Measures**

	GO	NO GO
1 Determined vehicle load capacity.	_____	_____
2 Directed nonmedical Soldiers to load an M-1085.	_____	_____
3 Directed nonmedical Soldiers to load an M-1093.	_____	_____
4 Directed nonmedical Soldiers to load an M-1081.	_____	_____

**Evaluation Guidance:** Score each Soldier according to the performance measures. Unless otherwise stated in the task summary, the Soldier must pass all performance measures to be scored GO. If the Soldier fails any steps, show what was done wrong and how to do it correctly.

**References**

**Required**  
None

**Related**  
FM 8-10-6

## Load Casualties onto Nonstandard Vehicles, 1 1/4 Ton, 4 x 4, M998

081-833-0171

**Conditions:** You have completed treating and triaging multiple casualties. You are in charge of loading litter or ambulatory patients onto a non-standard transport vehicle (M998). You will need litters and a non-standard vehicle. You are not in a CBRN environment.

**Standards:** Load litter casualties in accordance with (IAW) the proper loading sequence without causing further injury.

### Performance Steps

1. Determine vehicle load capacities.
  - a. M998 (four-seat configuration)- three litters.
  - b. M998 (two-seat configuration)- five litters.
2. Direct nonmedical Soldiers to load an M998 (four-seat configuration). (See Figure 3-17.)

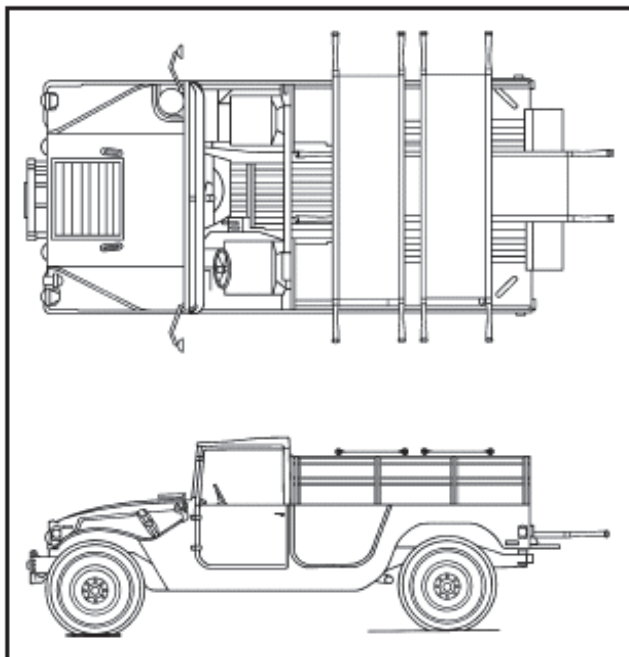

Figure 3-17. Load an M998

- a. Remove the cargo cover and metal bows. Secure them in the vehicle and lower the tailgate.
  - b. Place two litters side-by-side across the back of the truck with the litter handles resting on the sides of the truck.
  - c. Secure the litters to the vehicle with any available material.
  - d. Place one litter lengthwise, head first, in the bed of the truck. Secure it in place.
  - e. Leave the tailgate open and supported by the two tailgate chain hooks.
3. Direct nonmedical Soldiers to load a M998 (two-seat configuration). (See Figure 3-18.)

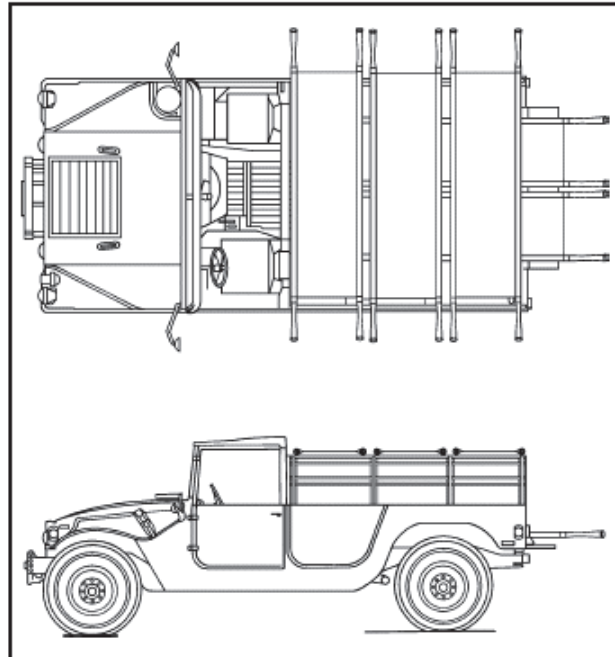

Figure 3-18. Load an M998

- a. Fold the fabric cover and metal bows forward and together as an assembly. Secure them in place. Lower the tailgate.
- b. Place three litters side-by-side across the sideboards. Secure them in place with any material available.
- c. Place two litters lengthwise, head first, in the bed of the truck. Secure them in place with any material available.
- d. Leave the tailgate open and supported by the two tailgate chain hooks.

**Evaluation Preparation:**

Setup: For training and evaluation, use other Soldiers as litter bearers and simulated casualties.

Brief Soldier: Tell the Soldier the simulated casualties require loading onto nonstandard vehicles. The Soldier will perform the task as the lead litter bearer and instruct the other litter bearers on the loading sequence of casualties.

**Performance Measures**

	GO	NO GO
1 Determined vehicle load capacities.	_____	_____
2 Directed nonmedical Soldiers to load an M998 (four-seat configuration).	_____	_____
3 Directed nonmedical Soldiers to load an M998 (two-seat configuration).	_____	_____

**Evaluation Guidance:** Score each Soldier according to the performance measures. Unless otherwise stated in the task summary, the Soldier must pass all performance measures to be scored GO. If the Soldier fails any steps, show what was done wrong and how to do it correctly.

**References**

**Required**

None

**Related**

FM 8-10-6

## Load Casualties Onto a CH-47 Series Helicopter

081-833-0287

**Conditions:** You have completed treating and triaging multiple casualties. You are in charge of loading litter and ambulatory patients onto a standard CH-47 helicopter. You will need a CH-47 helicopter, a medical evacuation litter installation kit, and litters. You are not in a CBRN environment.

**Standards:** Load and secure casualties onto the evacuation platform, in the correct sequence, without causing further injury.

### Performance Steps

1. Follow principles of loading casualties aboard a rotary-wing aircraft.

*NOTE:* The CH-47 has a number of possible seating or cargo configurations. In order to prepare the CH-47 to carry litter patients, a medical evacuation litter installation kit must be installed. The medical evacuation litter installation kit is installed only by the Crew Chief and not the medical personnel. This kit consists of 12 litter poles each with 4 litter support brackets attached to one litter strap.

- a. Responsibility for loading and securing patients on a rotary-wing aircraft.

- (1) The pilot in command has the overall responsibility for the proper loading and securing of litter and ambulatory casualties and related equipment on board the aircraft.

- (2) The final decision regarding how many casualties may be safely loaded rests with the pilot in command.

- (3) The crew members are responsible for ensuring that the litter squad follows the prescribed methods for loading litter or ambulatory casualties and securing litters and related medical equipment.

- (4) If there is a medic onboard, the medic will determine where each ambulatory and litter patient is placed in the aircraft to better facilitate in-flight medical treatment.

- b. Safety measures.

- (1) Litter bearers must present as low a silhouette as possible when approaching the aircraft at all times.

- (2) The helicopter must not be approached until a crew member signals to do so.

- (3) The litter bearers should approach the aircraft from the rear.

- (4) If the helicopter is on a slope and conditions permit, loading personnel should approach the aircraft from the downhill side.

- (5) Directions given by the crew members must be followed, and litters must be carried parallel to the ground.

- (6) All patient equipment such as blankets should be secured to the litter to prevent any potential damage to the aircraft.

- (7) Smoking is not permitted within 50 feet of the aircraft.

2. Determine CH-47 rotary wing aircraft load capabilities.

- a. The helicopter's maximum capacity is 24 litter patients or 31 ambulatory patients.

- b. Combinations of casualty litter /ambulatory capability:

- (1) 31 ambulatory / 0 litter.

- (2) 25 ambulatory / 4 litter.
- (3) 19 ambulatory / 8 litter.
- (4) 16 ambulatory / 12 litter.
- (5) 10 ambulatory / 16 litter.
- (6) 4 ambulatory / 20 litter.
- (7) 1 ambulatory / 24 litter.

3. Assess the litter casualties to determine the loading sequence.

a. The most seriously injured casualties are loaded last. If it is anticipated that a casualty's medical condition may require in-flight emergency medical care (such as cardiopulmonary resuscitation), he should be loaded onto the bottom litter support brackets.

b. Casualties in traction splits should be loaded on the bottom litter support brackets.

c. The CH47 should be loaded from the front to the rear with the most critical casualties loaded on last so they can be the first to be off loaded at the medical treatment facility.

d. When there are large amounts of litter and ambulatory casualties, the litter casualties should be loaded on the same side of the aircraft and the ambulatory casualties on the opposite side.

4. Prepare the aircraft to receive litter casualties. Pull down the locking handles of all of the litter support brackets.

5. Direct nonmedical Soldiers to load and secure litter casualties.

a. Have the litter bearer team carry the least critical litter casualties on first towards the front of the aircraft.

b. When loading the litter casualties onto a tier (stack of four litters) load from the top of the tier to the bottom.

c. Place the litter handles into the litter support brackets.

d. When all four litter handles are in place, reengage the handle clip in the locking bar and lock the bracket by moving the locking handle upward.

e. Once all four litter handles are in place, attach the fitting on the bottom of each litter support strap to the proper stud on the cargo floor. Press inward on the spring lever, slipping the catch over the stud and release the spring lever when it is centered over the proper stud.

f. Tighten the litter support strap by pulling on the free end of the strap until the strap is sufficiently tight.

g. Repeat these steps for each litter casualty.

**Evaluation Preparation:**

Setup: For training and evaluation, use a CH-47 with air crew and multiple simulated casualties, both ambulatory and litter.

Brief Soldier: Tell the Soldier the simulated casualties require being loaded onto the CH-47.

**Performance Measures**

GO NO GO

- |   |   |       |       |
|---|---|-------|-------|
| 1 | Followed the principles of loading casualties on a rotary-wing aircraft and determined load capabilities. | _____ | _____ |
| 2 | Determined CH-47 load Capacities.   | _____ | _____ |
| 3 | Assessed the litter casualties to determine loading sequence.   | _____ | _____ |
| 4 | Prepared the aircraft to receive litter casualties.   | _____ | _____ |
| 5 | Directed nonmedical Soldiers to load and secure casualties.   | _____ | _____ |

**Evaluation Guidance:** Score each Soldier according to the performance measures. Unless otherwise stated in the task summary, the Soldier must pass all performance measures to be scored GO. If the Soldier fails any steps, show what was done wrong and how to do it correctly.

**References**

**Required**  
None

**Related**  
None

## Load Casualties onto a Stryker Armored Ambulance

**081-833-0226**

**Conditions:** You have completed treating and triaging multiple casualties. You are in charge of loading litter and ambulatory casualties on a STRYKER armored ambulance. You will need a STRYKER armored ambulance and litters. You are not in a CBRN environment.

**Standards:** Configure the STRYKER properly and load casualties in the correct sequence for the transport platform.

### Performance Steps

1. Configure the casualty compartments for litter casualties.
  - a. Move the medical attendant's center seat to the configure position.
  - b. Remove litters from the stowed position.
  - c. Remove the platform from the stowage mount.
    - (1) Position one person at each translation beam.
    - (2) Remove the quick release pins that hold the translation beams in place on the stowage mount.
    - (3) Holding the translation beam with two hands, both people push out and lift up to disengage the translation beam from the stowage mounts.
    - (4) Rotate platform so it is horizontal and translation beams are lined up with support mounts on sponson wall.
    - (5) Insert translation beams into support mounts.
    - (6) Push down on each translation beam until it is fully engaged in support mount.
    - (7) Insert quick release pins to hold translation beams in place.
    - (8) Unlatch forward and rear platform latches and move platform out towards sponson wall approximately 1 inch so that platform latch will not engage detent and hold platform in configure position.
    - (9) Turn down platform hatch handles and continue to move platform out until both latches engage detent, locking platform in transport position.
  - d. Retrieve the lift arms from stowage.
  - e. Attach lift arms.
    - (1) Open the litter latches.
    - (2) Pull out and hold the locking pin on the underside of the lift arm.
    - (3) Hold out the locking pin and position the lift arm over the lift arm mount so the litter latch pin is on the outside.
    - (4) Push down on the lift arm until it is fully engaged on the lift arm mount.
    - (5) Release the locking pin to lock the lift arm on the lift arm mount.
    - (6) Repeat steps 1e(1) through 1e(5) to attach the lift arm to the other lift arm mount.

- f. Lower the lift arm.
  - (1) Pull the E-Stop switch on the litter control box out and up to RUN.
  - (2) Press and hold the litter control switch in the DOWN position until the lift arm is lowered.
  - (3) Push the E-Stop switch down to DISABLE.
2. Load an upper litter casualty.
  - a. Lower the ramp.
  - b. If the lift arms are lowered, proceed to step 2c. If the lift arms are raised, do the following:
    - (1) Unlatch the forward and rear platform latches and move the platform towards the center of the vehicle.
    - (2) Re-engage the forward and rear latches to hold the platform in the load position.
  - c. Load the casualty.
    - (1) Slide the casualty head first along the litter tracks.
    - (2) Unlatch the forward and rear platform latches and slide the platform toward the wall.
    - (3) Lock the forward and rear platform latches with the platform in the transport position.
  - d. Lock the litter latches of the lift arms on all four litter handles.
  - e. Raise the casualty to the upper position.
    - (1) Pull the E-Stop switch on the litter control box out and up to RUN.
    - (2) Press and hold the litter control switch in the up position until the lift arm reaches MAX HEIGHT position.
    - (3) Push the E-Stop switch down to DISABLE.
3. Load a lower litter casualty.
  - a. Unlatch forward and rear platform latches and move platform towards center of vehicle, re-engage forward and rear latches to hold platform in load position.
  - b. Slide casualty head first along litter tracks, unlatch forward and rear platform latches and slide platform toward wall, lock forward and rear platform latches with platform in transport position.
  - c. Insert litter locking pins into all four litter stirrups.
4. Load ambulatory casualties.
  - a. Seat ambulatory casualties on the bench and secure them with seat restraints.
  - b. Raise the ramp making sure there are no obstructions.

**Evaluation Preparation:**

Setup: For training and evaluation, use other Soldiers as litter bearers and casualties.

Brief Soldier: Tell the Soldier that the simulated Soldiers require loading onto the STRYKER. The graded Soldier will be the primary litter bearer and decide loading priorities.



<b>Performance Measures</b>	GO	NO GO
1 Configured the casualty compartments for litter casualties.	_____	_____
2 Loaded an upper litter casualty and properly secured the litter to the lift arm.	_____	_____
3 Loaded a lower litter casualty and properly secured the litter to the platform.	_____	_____
4 Loaded and secured ambulatory casualties.	_____	_____

**Evaluation Guidance:** Score each Soldier according to the performance measures. Unless otherwise stated in the task summary, the Soldier must pass all performance measures to be scored GO. If the Soldier fails any steps, show what was done wrong and how to do it correctly.

### References

**Required**  
None

**Related**  
081-MEV1  
TM 9-2355-311-10-1-1

## Unload Casualties From a Stryker Armored Ambulance

081-833-0296

**Conditions:** You have completed transporting multiple litter and/or ambulatory casualties to a medical treatment facility (MTF). You are in charge of unloading litter and/or ambulatory casualties from a STRYKER MEV ambulance. You will need a STRYKER MEV armored ambulance and litters. You are not in a CBRN environment.

**Standards:** Unload the STRYKER MEV in the correct sequence for the transport platform.

### Performance Steps

1. Unload ambulatory casualties.
  - a. Lower the ramp making sure that there are no obstructions.
  - b. Release the restraints and have the ambulatory casualties exit the STRYKER MEV by way of the ramp.
2. Unload the lower litter casualty.
  - a. The proper unloading sequence for the STRYKER MEV is the bottom left, top left, bottom right and top right.
  - b. Remove the litter locking pins from all four litter stirrups.
  - c. Unlock the forward and rear platform latches and slide the platform toward the center of the vehicle.
  - d. Re-engage the forward and rear latches to hold the platform in the load position.
  - e. Have one litter bearer support the litter and slide it toward the ramp, simultaneously position a litter bearer on each side of the litter to support the litter prior to the litter clearing the litter tracks.
  - f. Unload the litter by sliding it along the litter tracks until the litter is clear of the platform and carry the casualty out of the STRYKER MEV by way of the ramp.
  - g. Slide the empty platform toward the wall and engage the forward and rear platform latches to hold the platform in place.
3. Unload the upper litter casualty.
  - a. Pull the E-Stop switch on the litter control box out and up to RUN.
  - b. Press and hold the litter control switch in the down position until the lift arm reaches the lowest level position.
  - c. Push the E-Stop switch down to DISABLE.
  - d. Remove the litter locking pins from all four litter stirrups.
  - e. Unlock the forward and rear platform latches and slide the platform toward the center of the vehicle.
  - f. Re-engage the forward and rear latches to hold the platform in the load position.
  - g. Have one litter bearer support the litter and slide it toward the ramp, simultaneously position a litter bearer on each side of the litter to support the litter prior to the litter clearing the litter tracks.
  - h. Unload the litter by sliding it along the litter tracks until the litter is clear of the platform and carry the casualty out of the STRYKER MEV by way of the ramp.

4. Store the litter transport platform.

a. Replace the litters in the stowed position.

b. Remove lift arms.

(1) Open the litter latches.

(2) Pull out and hold the locking pin on the underside of the lift arm.

(3) Pull up on the lift arm until it is fully disengaged from the lift arm mount.

(4) Hold the locking pin to remove the lift arm from the lift arm mount.

c. Replace the platform into the stowage mount.

(1) Position one person at each translation beam.

(2) Unlatch the forward and rear platform latches and move the platform out towards the center of the patient compartment approximately 1 inch so that the platform latch will not engage the detent and hold the platform in the configure (middle) position.

(3) Turn up the platform hatch handles and continue to move the platform out until both latches engage the detent, locking the platform in the middle stowage position.

(4) Replace the translation beams to the stowage mounts.

(a) Support the platform and remove the four translation beam pins.

(b) Grab the platform with one hand and the translation beam with the other and pull up until the platform slides up and separates from the horizontal mounts.

(c) Rotate the platform vertically and allow the pan to fall into place on the stowage mounts.

(d) Seat the translation beams into the stowage mounts and secure the platform with the four translation beam pins.

(e) Wiggle the platform back and forth until the four translation beam pins seat completely.

(5) Raise the seatback in the vertical position and secure by turning the seat back lock into the locked position.

(6) Raise the bench seat and stow the lift arms in the stowage areas.

(7) Secure the bench seat by locking the bench seat latches.

**Evaluation Preparation:**

Setup: For training and evaluation, use a STRYKER MEV and multiple Soldiers to be simulated casualties and litter bearers.

Brief Soldier: Tell the Soldier the simulated patients require off loading the STRYKER MEV.

**Performance Measures**

- 1 Unloaded the ambulatory casualties.
- 2 Unloaded the lower litter casualties.
- 3 Unloaded the upper litter casualties.
- 4 Stored the litter transport platform.

GO	NO GO
_____	_____
_____	_____
_____	_____
_____	_____

**Evaluation Guidance:** Score each Soldier according to the performance measures. Unless otherwise stated in the task summary, the Soldier must pass all performance measures to be scored GO. If the Soldier fails any steps, show what was done wrong and how to do it correctly.

**References**

**Required**  
None

**Related**  
081-MEV1

## Establish a Helicopter Landing Point

**071-334-4002**

**Conditions:** As a squad leader of an Infantry squad, given smoke grenades, strobe lights, flashlights or vehicle lights, marker panels, and the equipment and personnel to clear the site. You have been directed to establish a location for a helicopter to land.

**Standards:** Select a landing site, establish security for the landing site, and mark the landing site and touchdown point. Ensure the landing site is large enough for a helicopter to land and take off without exposing it to unneeded risks.

**NOTE:** Comply with unit standard operating procedure (SOP) and or local environmental regulations concerning the cutting of live vegetation, digging holes, and or erosion prevention.

### Performance Steps

1. Select a landing site.
  - a. Determine the size of the landing site.

**NOTE:** A helicopter requires a relatively level landing point. Most helicopters cannot go straight up or down when fully loaded. Therefore, a larger landing site and better approach and departure routes are required.

(1) Select an area at least 30 meters in diameter for a UH-60 series aircraft and 80 meters in diameter for a CH-47 series aircraft.

(2) Use a 10 to 1 ratio to lay out the landing site, when obstacles are in the approach or departure routes.

**NOTE:** For example, during the approach and departure, if the helicopter must fly over trees that are 15 meters high, the landing site must be at least 150 meters long ( $10 \times 15 = 150$  meters).

- b. Select a ground slope that does not exceed 7 degrees.

**NOTE:** Helicopters cannot safely land on a slope of more than 15 degrees. When the ground slope is under 7 degrees, the helicopter should land up slope. When the ground slope is 7 to 15 degrees, the pilot is advised and the helicopter must land side slope.

**CAUTION:** Never land an aircraft downslope, if possible.

- c. Determine surface conditions.

(1) Ensure the ground is firm enough that the helicopter does not bog down during loading or unloading.

**NOTE:** If firm ground cannot be found, issue the pilot an advisory. The pilot can hover at the landing site during the loading or unloading.

(2) Avoid areas which may cause loss of visual contact with the ground such as rotor wash on dusty, sandy, or snow-covered surfaces.

**CAUTION:** Loose debris can cause damage to the blades or engines.

- (3) Remove loose debris that can be kicked up by the rotor wash from the landing site.

- d. Identify all obstacles within the landing site.

**NOTE:** Obstacles are any object that are 18 inches high, wide, or deep.

- (1) Remove all obstacles such as stumps, rocks, or holes.

- (2) Clearly mark unmovable obstructions and advise the pilot.

2. Establish security for the landing site.

*NOTE:* Landing sites should offer some security from enemy observation and direct fire. Good landing sites will allow the helicopter to land and depart without exposing it to unneeded risks. Security is normally established around the entire landing site.

3. Mark the landing site and touchdown point.

- a. Use color smoke to give pilot information on the wind direction and speed.
- b. Use a signalman.

**CAUTION:** Do not use any closer than 50 feet to the touchdown point.

- c. Use VS-17 marker panels to mark the landing site.
- d. Conduct night operations.

*NOTE:* Pilot's NVGs have filtered lenses that do not allow them to see blue or green chem-lights.

- (1) Mark landing site by an inverted "Y" composed of four lights.
- (2) Use strobe lights, or chem-lights, flashlights, or vehicle lights to mark the landing site.
- (3) Fully explain the marking system to the pilot when contact is made.

**Evaluation Preparation:**

Set up: Provide the Soldier with the equipment and/or materials described in the condition statement.

Brief the Soldier: Tell the Soldier what is expected of him by reviewing the task standards. Stress to the Soldier the importance of observing all cautions and warnings to avoid injury to personnel and, if applicable, damage to equipment.

<b>Performance Measures</b>	GO	NO GO
1 Selected a landing site.	_____	_____
2 Established security for the landing site.	_____	_____
3 Marked the landing site and the touchdown point.	_____	_____

**Evaluation Guidance:** Score the Soldier GO if all performance measures are passed. Score the Soldier NO-GO if any performance measure is failed. If the Soldier scores NO-GO, show the Soldier what was done wrong and how to do it correctly.

**References**

**Required**  
None

**Related**  
FM 21-60  
FM 3-21.8

## Unload Casualties From a CH-47 Series Helicopter

081-833-0295

**Conditions:** A CH-47 series helicopter has arrived at your medical treatment facility (MTF) with multiple casualties. You are in charge of unloading litter and ambulatory patients from a standard CH-47 helicopter. You will need a CH-47 series helicopter that includes a medical evacuation litter installation kit, and litters. You are not in a CBRN environment.

**Standards:** Unload the CH-47 series helicopter in the correct sequence without causing further injury.

### Performance Steps

1. Follow principles of unloading casualties from a rotary-wing aircraft.
  - a. Responsibility for unloading and securing patients from a rotary-wing aircraft.
    - (1) The pilot in command has the overall responsibility for the proper unloading of the aircraft, as well as, all safety considerations inside and around the aircraft.
    - (2) The Crew Chief is responsible for ensuring that the litter squad follows the prescribed methods for unloading litter and ambulatory casualties and securing litters and related medical equipment.
    - (3) The crew members are responsible for ensuring that the litter squad follows the prescribed methods for loading litter or ambulatory casualties and securing litters and related medical equipment.
    - (4) If there is a medic onboard, the medic will determine which casualties are unloaded first.
  - b. Safety measures.
    - (1) Litter bearers must present as low a silhouette as possible when approaching the aircraft at all times.
    - (2) The helicopter must not be approached until a crew member signals to do so.
    - (3) The litter bearers should approach the aircraft from the rear.
    - (4) If the helicopter is on a slope and conditions permit, loading personnel should approach the aircraft from the downhill side.
    - (5) Directions given by the crew members must be followed, and litters must be carried parallel to the ground.
    - (6) All patient equipment such as blankets should be secured to the litter to prevent any potential damage to the aircraft.
    - (7) Smoking is not permitted within 50 feet of the aircraft.
2. Direct nonmedical Soldiers to unsecure and unload litter casualties.
  - a. Have the litter bearer team approach the litters located at the rear of the aircraft first.
  - b. Each litter tier (stack of four litter casualties) should be unloaded from bottom to the top.
  - c. Have the litter bearer team unsecure the litter by pulling down on all four of the locking handles that was securing one litter to the litter support brackets.
  - d. Carefully have the litter bearer team move the litter to the center of the aircraft and then proceed to carry the litter down the aft ramp and out of the aircraft.

e. Have the litter bearer team repeat steps 3a-3d until all litter casualties have been unloaded from the aircraft.

3. Escort ambulatory casualties from aircraft.

**Evaluation Preparation:**

Setup: For training and evaluation, use a a CH-47 with air crew and multiple simulated casualties, both ambulatory and litter.

Brief Soldier: Tell the Soldier the simulated casualties require being offloaded from the CH-47.

<b>Performance Measures</b>	<b>GO</b>	<b>NO GO</b>
1 Followed the principles of unloading casualties on a rotary-wing aircraft.	_____	_____
2 Directed the nonmedical Soldiers to unsecure and unload all litter casualties.	_____	_____
3 Escorted the ambulatory casualties from the aircraft.	_____	_____

**Evaluation Guidance:** Score each Soldier according to the performance measures. Unless otherwise stated in the task summary, the Soldier must pass all performance measures to be scored GO. If the Soldier fails any steps, show what was done wrong and how to do it correctly.

**References**

**Required**  
None

**Related**  
None



**Load Casualties onto Nonstandard Vehicles, 2 1/2 Ton, 6X6 or 5 Ton, 6X6, Cargo Truck  
081-833-0172**

**Conditions:** You have completed treating and triaging multiple casualties. You are in charge of loading litter casualties onto a non-standard transport vehicle. You will need litters, four Soldiers, 550 cord or rope and a 2 1/2 ton or 5 ton cargo truck. You are not in a CBRN environment.

**Standards:** Load litter casualties without causing further injury.

**Performance Steps**

1. Determine vehicle load capacities.
  - a. 12 litters.
  - b. 16 ambulatory.
2. Prepare the vehicle to receive casualties.
  - a. Remove the canvas cover. (The cover can be rolled toward the front of the truck and secured.)
  - b. Lower the bench seats on both sides of the truck bed.
3. Direct nonmedical Soldiers to load the vehicle.
  - a. Place three litters crosswise on the seats as far forward as possible and three litters lengthwise in the bed of the truck as far forward as possible.
  - b. Secure the litters individually to the seats.
  - c. Place three additional litters crosswise on the seats and three additional litters lengthwise in the bed of the truck.
  - d. Secure the litters individually to the seats.
  - e. Raise and secure the tailgate as high as possible to help secure the litters in place.

**NOTE:** The casualties with the most serious wounds should be loaded last to ensure that they are the first to be unloaded upon arrival at the military treatment facility (MTF). All treatment must be performed prior to loading and transport due to no medical care provided while the vehicle is en-route. Once the bed of the truck is fully loaded with 12 litters, there is not enough room for a medic to provide treatment en-route.

**Evaluation Preparation:**

Setup: For training and evaluation, use other Soldiers as litter bearers and simulated casualties.

Brief Soldier: Tell the Soldier the simulated casualties require loading onto nonstandard vehicles. The Soldier will perform the task as the leadlitter bearer and instruct the other litter bearers on the loading sequence of casualties.

**Performance Measures**

	GO	NO GO
1 Determined vehicle load capacity.	_____	_____
2 Prepared the vehicle to receive casualties.	_____	_____
3 Directed nonmedical Soldiers to load the vehicle.	_____	_____

**Evaluation Guidance:** Score each Soldier according to the performance measures. Unless otherwise stated in the task summary, the Soldier must pass all performance measures to be scored GO. If the Soldier fails any steps, show what was done wrong and how to do it correctly.

**References**

**Required**  
None

**Related**  
None

**Unload Casualties From Nonstandard Vehicles, 5 Ton M-1085, M-1093, 2 1/2 Ton M-1081  
081-833-0289**

**Conditions:** A nonstandard vehicle has arrived at your MTF with multiple casualties. You are in charge of unloading litter casualties from a non-standard transport vehicle. You will need a litter team of four Soldiers and a 5 ton M-1085 / M-1093 or a 2 1/2 ton M-1081 cargo truck. You are not in a CBRN environment.

**Standards:** Unload litter casualties in accordance with (IAW) with the proper sequence without causing further injury.

*NOTE:* When unloading litters from the vehicle bed, take care not to cause further injury to the casualty by allowing the litter stirrups to slide off of the vehicle bed which could cause the casualty to hit his head on the edge of the vehicle bed.

**Performance Steps**

1. Prepare the vehicle for unloading litter casualties.
  - a. Open the tailgate.
  - b. Unsecure the litters that are lying crosswise on the seats.
2. Direct nonmedical Soldiers to unload casualties from the non-standard vehicle.
  - a. Unload the M-1085.
    - (1) Remove the first two litters that are lying on the bed of the vehicle (litters 12 and 11).
    - (2) Remove litters 10, 9, 8 and 7 (the first four litters loaded crosswise on the seats closest to the tailgate).
    - (3) Remove the litters 6 and 5 (loaded on the bed of the vehicle closest to the vehicle cab).
    - (4) Remove litters 4, 3, 2 and 1 (the last four litters loaded crosswise on the seats).
  - b. Unload the M-1093.
    - (1) Remove litters 8, 7 and 6 (that were loaded crosswise on the seats nearest to the tailgate).
    - (2) Remove litters 5 and 4 (that were loaded lengthwise on the bed).
    - (3) Remove litters 3, 2 and 1 (which were loaded crosswise on the seats closest to the vehicle cab).
  - c. Unload a M-1081.
    - (1) Remove litters 7 and 6 (that were loaded crosswise on the seats closest to the tailgate).
    - (2) Remove litters 5 and 4 (that were loaded lengthwise on the bed of the vehicle).
    - (3) Remove litters 3, 2 and 1 (which were loaded crosswise on the seats closest to the vehicle cab).
3. Do not cause further injury to the casualties.

**Evaluation Preparation:**

Setup: For training and evaluation, have a group of casualties and other Soldiers and the appropriate vehicles along with the Soldier that is to be evaluated.

Brief Soldier: Tell the Soldier unload the casualties from the non-standard vehicle.

<b>Performance Measures</b>	<b>GO</b>	<b>NO GO</b>
1 Prepared the vehicle for unloading litter casualties.	_____	_____
2 Directed nonmedical Soldiers to unload the casualties from the non-standard vehicle.	_____	_____
3 Did not cause further injury to the casualties.	_____	_____

**Evaluation Guidance:** Score each Soldier according to the performance measures. Unless otherwise stated in the task summary, the Soldier must pass all performance measures to be scored GO. If the Soldier fails any steps, show what was done wrong and how to do it correctly.

**References**

**Required**  
None

**Related**  
None

**Unload Casualties From Nonstandard Vehicles, 1 1/4 TON, 4 x 4, M998**

**081-833-0290**

**Conditions:** A non-standard vehicle (1 1/4 ton, 4 x 4, M998) has arrived at your medical treatment facility. You are in charge of unloading litter or ambulatory patients from a non-standard transport vehicle (M998). You will need litters, litter straps, securing material and a non-standard vehicle. You are not in a CBRN environment.

**Standards:** Unload litter casualties in accordance with (IAW) the proper unloading sequence without causing further injury.

**Performance Steps**

1. Unsecure litters by removing all securing materials from all the litters.
2. Direct nonmedical Soldiers to remove litter/litters from the bed of the truck.
3. Direct nonmedical Soldiers to remove the litters from the sideboards of the truck.
4. Close the tail gate and secure with the tail gate chain hooks.

**Evaluation Preparation:**

Setup: Evaluate this task during a training exercise or simulate it by creating a scenario, and provide the equipment needed for the evaluation.

Brief Soldier: Tell the Soldier the scenario to include the end result desired.

**Performance Measures**

	GO	NO GO
1 Unsecured litters.	_____	_____
2 Directed nonmedical Soldiers to remove the litter/litters from the bed of the truck.	_____	_____
3 Directed nonmedical Soldiers to remove the litters from the sideboards of the truck.	_____	_____
4 Closed the tail gate and secure with the tail gate chain hooks.	_____	_____

**Evaluation Guidance:** Score each Soldier according to the performance measures. Unless otherwise stated in the task summary, the Soldier must pass all performance measures to be scored GO. If the Soldier fails any steps, show what was done wrong and how to do it correctly.

**References**

**Required**  
None

**Related**  
None

## Unload Casualties From Nonstandard Vehicles, 2 1/2 Ton, 6X6 or 5 Ton, 6X6 Cargo Truck

081-833-0288

**Conditions:** A non-standard vehicle has arrived at your MTF with multiple casualties. You are in charge of unloading litter casualties from a non-standard transport vehicle. You will need a litter team of four Soldiers and a 2 1/2 ton or 5 ton cargo truck. You are not in a CBRN environment.

**Standards:** Unload litter casualties in reverse order from the proper loading sequence without causing further injury.

### Performance Steps

1. Prepare the casualties for off loading.
  - a. Unsecure and lower the tailgate.
  - b. Remove securing rope or 550 cord from each litter.
2. Direct nonmedical Soldiers to unload the vehicle in reverse sequence.
  - a. Remove the first three litters that are placed lengthwise on the bed of the truck.
  - b. Remove the first three litters that are crosswise supported by the bench seats.
  - c. Remove the last three litters that were placed lengthwise on the bed of the truck.
  - d. Remove the last three litters that were placed crosswise and supported by the bench seats.

**NOTE:** Ensure that there is no further injury when off loading the casualties from the truck, by preventing the litter from dropping when the stirrups clear the truck bed.

3. Secure the tailgate.

### Evaluation Preparation:

Setup: For training and evaluation use a 2 1/2 ton vehicle and four Soldiers to assist.

Brief Soldier: Tell the Soldier there are casualties that require being unloaded from the vehicle.

### Performance Measures

	GO	NO GO
1 Prepared the casualties for off loading.	_____	_____
2 Directed nonmedical Soldiers to unload the vehicle in reverse sequence.	_____	_____
3 Secured the tailgate.	_____	_____

**Evaluation Guidance:** Score each Soldier according to the performance measures. Unless otherwise stated in the task summary, the Soldier must pass all performance measures to be scored GO. If the Soldier fails any steps, show what was done wrong and how to do it correctly.

### References

**Required**  
None

**Related**  
None

## **Establish an Ambulance Exchange Point**

**081-833-0184**

**Conditions:** You need to establish an ambulance exchange point (AXP). You will need combat service support and operation overlays. You are not in a CBRN environment.

**Standards:** Establish an ambulance exchange point to facilitate evacuation of casualties.

### **Performance Steps**

1. Select the site for an ambulance exchange point (AXP) based on the tactical mission.
  - a. The location of the AXP will depend on the location and number of units being supported.
  - b. This location should provide the required support to reduce ambulance turnaround time to supported units.
  - c. When supporting tracked vehicles the AXP should be located as close as possible to the supported unit to reduce the time and distance requirements for the tracked vehicles.
  - d. The AXP may be an established point in an ambulance shuttle or it may be designated independently.
2. Establish the AXP.
  - a. AXPs may be staffed or unstaffed.
    - (1) Points that are not staffed may serve as rendezvous points for the rapid transfer of a patient from one transportation mode to another.
    - (2) In most cases AXPs will not be staffed.
    - (3) The ambulance platoon leader/sergeant coordinates/establishes the AXPs as required by the medical evacuation mission.
  - b. The medical evacuation plan should include an overlay depicting (at a minimum) the location of supported units, casualty collection points, Role I facilities, and AXPs.
    - (1) The platoon leader should also obtain the combat service support and operations overlays for the tactical operation. These overlays provide valuable information on:
      - (a) Mine fields.
      - (b) Obstacles and barriers.
      - (c) Artillery target reference points.
      - (d) Air corridors.
    - (2) Supported units.
      - (a) An AXP may serve two to three battalions/squadrons (brigade support medical company/medical troop) or a specific number of non divisional Role I facilities (area support medical company).
      - (b) In these cases the AXP should be centrally located to reduce ambulance turnaround and enhance the timely execution of the medical evacuation mission.

**Evaluation Preparation:** Setup: At the test site, provide all equipment, information, and personnel given in the task conditions statement. Brief Soldier: Tell the Soldier that they are to select and prepare an AXP.

**Performance Measures**

GO      NO GO

- 1 Selected a site for an AXP based on the tactical mission.
- 2 Established the AXP.

\_\_\_\_    \_\_\_\_  
\_\_\_\_    \_\_\_\_

**Evaluation Guidance:** Score each Soldier according to the performance measures. Unless otherwise stated in the task summary, the Soldier must pass all performance measures to be scored GO. If the Soldier fails any steps, show what was done wrong and how to do it correctly.

**References**

**Required**  
None

**Related**  
ATTP 4-02

FM 8-10-6



**Subject Area 18: Medication Administration****Administer Ear Medications****081-833-0020**

**WARNING:** Instillation of eardrops containing hydrocortisone is contraindicated if the patient has herpes, another viral infection or a fungal infection.

**CAUTION:** Instillation of eardrops is usually contraindicated if the patient has a perforated eardrum, but it may be permitted with certain medications and adherence to sterile technique.

**Conditions:** You have a patient requiring ear medication to be instilled. You will need the ear medication, a patient's clinical records, light source, facial tissue or cotton-tipped applicator, gauze pads (2 x 2 or 4 x 4) gloves, waterproof pad (chux), medicine dropper, normal saline solution. You have performed a patient care handwash and you are not in a CBRN environment.

**Standards:** Instill ear medications without causing harm to patient.

**Performance Steps**

1. Ask the patient about allergies.
2. Explain the procedure.
  - a. Instruct the patient that it will be necessary for them to lie still for 5 to 10 minutes after procedure.
  - b. Explain possible side effects after medication is instilled.
    - (1) Change in hearing.
    - (2) Itching or rash.
    - (3) Stinging or burning of the ear.
    - (4) Dizziness.
    - (5) Ringing in ear(s).
3. Prepare medication.
  - a. Ensure medication's color has not changed, does not look cloudy or has any floating particles in it.
  - b. Ensure medication is warmed to body temperature.
    - (1) Place in warm water.
    - (2) Carry the medication in your pocket for 30 minutes.
    - (3) Hold the bottle in between your hands for a few minutes.
  - c. Test the temperature of the medication on your wrist before instilling to ensure it is not too hot nor too cold.
4. Provide privacy for the patient.
5. Place the patient in a supine position with the head turned toward the unaffected side.

**NOTE:** If necessary, cleanse the external ear with saline solution and cotton balls or gauze squares.

6. Place waterproof pad (chux) under the affected ear.

7. Put on gloves.

**CAUTION:** Ensure you keep the tip of the dropper pointed downward to prevent medication from back flowing into the bulb and potentially contaminating the medication.

8. Remove cap from medication container.

*NOTE:* If a dropper is to be used, draw up the correct amount of medication. Do not contaminate the container cap.

9. Straighten patient's external canal with your non-dominant gloved hand.

a. Adult patient pull the auricle of the ear up and back.

b. Infant or child patient pull the auricle down and back.

10. Examine the ear canal for drainage using a light source.

*NOTE:* If you find any drainage, clean the ear canal before instilling medication as the drainage will reduce the medication's effectiveness.

11. Support the hand holding the dropper against the patient's head.

*NOTE:* Do not allow the dropper or the tip of the bottle to touch the patient's ear.

12. Instill the prescribed amount of medication one drop at a time using your dominant hand.

*NOTE:* Do not squeeze the bulb of the dropper too hard.

a. Direct the flow of medication toward the sides of the ear canal.

b. Hold the ear canal into position until you see the medication disappear down the canal.

13. Release the external canal gently.

*NOTE:* If ordered, place a cotton ball loosely into the opening of the patient's ear canal to prevent the medication from leaking out. Ensure that you don't place the cotton ball too deeply as this may prevent drainage of secretions and increase pressure on the eardrum.

14. Replace the cap (or dropper) on the medication bottle.

15. Clean and dry outer ear.

16. Instruct patient to remain on their side for 5 to 10 minutes.

*NOTE:* This will allow the medication time to absorb.

17. Instill medication in other ear if ordered.

18. Discard used supplies in container in accordance with (IAW) local policy and infection control guidelines.

19. Store medication IAW local standard operating procedure (SOP).

20. Record procedure on appropriate form.

a. Document amount and time medication was administered on DA Form 4678 (Therapeutic Documentation Care Plan (Medications) Record).

b. Document procedure and patient's tolerance of procedure on SF 510 (Nursing Notes).

**Evaluation Preparation:**

Setup: For training and evaluation, use another Soldier as a simulated patient.

Brief Soldier: Tell the Soldier the simulated patient requires ear medication to be administered.

<b>Performance Measures</b>	<b>GO</b>	<b>NO GO</b>
1 Asked the patient about allergies.	_____	_____
2 Explained the procedure.	_____	_____
3 Prepared medication.	_____	_____
4 Provided privacy for the patient.	_____	_____
5 Placed patient in a supine position and turned head toward the unaffected side.	_____	_____
6 Placed a waterproof pad (chux) under the affected ear.	_____	_____
7 Put on gloves.	_____	_____
8 Removed cap from medication container.	_____	_____
9 Straightened patient's external canal with non-dominant hand.	_____	_____
10 Examined ear canal for drainage using a light source.	_____	_____
11 Supported the hand holding the dropper against the patient's head.	_____	_____
12 Instilled the prescribed amount of medicine one drop at a time using dominant hand.	_____	_____
13 Released the external canal gently.	_____	_____
14 Replaced the cap (or dropper) on the medication bottle.	_____	_____
15 Cleaned and dried outer ear.	_____	_____
16 Instructed patient to remain on their side for 5 to 10 minutes.	_____	_____
17 Instilled medication in other ear if ordered.	_____	_____
18 Discarded used supplies in container IAW local policy and infection control guidelines.	_____	_____
19 Stored medication IAW local SOP.	_____	_____
20 Recorded procedure on DA Form 4678 or SF 510.	_____	_____

**Evaluation Guidance:** Score each Soldier according to the performance measures. Unless otherwise stated in the task summary, the Soldier must pass all performance measures to be scored GO. If the Soldier fails any steps, show what was done wrong and how to do it correctly.

### References

**Required**  
DA Form 4678  
SF 510

**Related**  
None

## Administer Eye Medications

081-833-0015

**Conditions:** You have a patient requiring eye medication to be administered. You will need tissues, sterile gauze, sterile normal saline, the prescribed medication, DA Form 4678 (Therapeutic Documentation Care Plan), and the patient's clinical record. You have performed a patient care handwash. You are not in a CBRN environment.

**Standards:** Administered eye medications without contamination and causing harm to the patient.

### Performance Steps

1. Check the medication sheet (DA Form 4678) against the medical officer's orders.
  - a. Name of the medication.
  - b. Amount (dose) of medication.
  - c. Route of administration.
  - d. Time to be administered.
  - e. Patient allergies.
2. Select the medication.

**WARNING:** Do not instill any medication in the eye unless it is labeled ophthalmic.

a. Check the medication label three times to ensure that the correct medication is being prepared for administration.

- (1) First time-when removing the medication container from the storage shelf.
- (2) Second time-when preparing the medication dose.
- (3) Third Time-when returning the container to the storage shelf.

b. Check the expiration date of the medication.

**NOTE:** If unfamiliar with a medication, look it up to determine contraindications, precautions, and side effects before preparing it for administration.

3. Take medication and other supplies to the patient.
4. Identify the patient and explain the procedure.
5. Position the patient.
  - a. Supine in bed.
  - b. Sitting, with the head tilted backward and slightly to the side into which the medication will be instilled.
6. Remove eye dressings, if present.
  - a. Glove.
  - b. Gently pull the dressing away from the forehead and then pull it down and away from the eye area.
  - c. Discard the contaminated dressing in accordance with local standard operating procedure (SOP).
7. Remove accumulation of secretions, if present.

a. Apply sterile gauze, moistened with sterile normal saline, to the closed eyes to soften the debris.

b. Wipe gently from the inner canthus to the outer canthus.

c. If needed, remove excess loosened debris by blotting with additional moistened gauze.

d. Remove gloves and discard in accordance with local SOP.

8. Prepare the medication.

a. Ointment tube.

(1) Remove the cap from the tube and place the cap on a piece of sterile gauze to prevent contamination.

(2) Squeeze a small amount of ointment onto a piece of sterile gauze to remove any crust that may have formed.

(3) Discard this gauze.

b. Eye dropper.

(1) Draw the prescribed amount of the medication into the dropper.

(2) Do not invert the dropper after withdrawing the solution.

c. Squeeze vial.

(1) Remove the cap and place it on a piece of sterile gauze.

(2) Invert the vial.

9. Administer the medication.

a. Instruct the patient to tilt the head back and look upward with the eyes open.

b. Steady the hand holding the medication container against the patient's forehead.

**WARNING:** Do not press on the eyeball.

c. Gently retract the lower eyelid with the first two fingers of your non-dominant hand.

d. Instill the correct number of drops or amount of ointment into the lower conjunctival sac.

e. Apply ointment in a thin ribbon from the inner aspect to the outer aspect of the lower conjunctival sac.

*NOTE:* Do not instill medication directly onto the eyeball.

10. Instruct patient to close the eyes gently and "roll" them to distribute the medication.

*NOTE:* Instruct the patient not to tightly squeeze the eyes shut.

11. Remove any excess solution or ointment by gently blotting with a clean tissue or gauze pad.

12. Apply fresh dressings or patches, if required.

13. Remove all equipment used.

14. Record the administration of all medications on the appropriate medical forms.

*NOTE:* Administration of all scheduled and nonscheduled (PRN) medication must be documented.

a. Initial the medication sheet (DA Form 4678).

b. Annotate in the nursing notes when administering nonscheduled medications and any other medications as required by local policy.

- (1) Name of the medication.
- (2) Time the medication was administered.
- (3) Reason for the medication.

15. Record the omission of a medication on the appropriate medical forms whenever a scheduled medication is not administered.

- a. Annotate on the medication sheet (DA Form 4678) by placing a circle in the initial block.
- b. Annotate in the nursing notes.
  - (1) Name of the medication.
  - (2) Time it should have been administered.
  - (3) Reason it was not administered.
  - (4) Follow-up action taken.

**Evaluation Preparation:**

Setup: For training and evaluation, use a simulation device capable of having eye drops administered.

Brief Soldier: Tell the Soldier the simulated patient requires eye medication to be administered.

<b>Performance Measures</b>	GO	NO GO
1 Checked the medication sheet (DA Form 4678) against the medical officer's orders.	_____	_____
2 Selected the medication.	_____	_____
3 Took medication and other supplies to the patient.	_____	_____
4 Identified the patient and explained the procedure.	_____	_____
5 Positioned the patient.	_____	_____
6 Removed eye dressings, if present.	_____	_____
7 Removed accumulation of secretions, if present.	_____	_____
8 Prepared the medication.	_____	_____
9 Administered the medication.	_____	_____
10 Instructed patient to close the eyes gently and "roll" them to distribute the medication.	_____	_____
11 Removed any excess solution or ointment by gently blotting with a clean tissue or gauze pad.	_____	_____
12 Applied fresh dressings or patches, if required.	_____	_____
13 Removed all equipment used.	_____	_____
14 Recorded the administration of all medications on the DA Form 4678.	_____	_____
15 Recorded the omission of a medication on the appropriate medical	_____	_____

**Performance Measures**

GO

NO GO

form whenever a scheduled medication was not administered.

**Evaluation Guidance:** Score each Soldier according to the performance measures. Unless otherwise stated in the task summary, the Soldier must pass all performance measures to be scored GO. If the Soldier fails any steps, show what was done wrong and how to do it correctly.

**References**

**Required**  
DA Form 4678

**Related**  
None

## Administer Topical Medications

081-835-3020

**Conditions:** You need to apply topical medications to a patient. You will need a tray, prescribed medication, medicated pads or patches, application papers, tape, gloves, DA Form 4678 (Therapeutic Documentation Care Plan), and the patient's clinical record. A patient care hand wash has been performed. You are not in a CBRN environment.

**Standards:** Prepared and administered topical medications without causing harm to the patient.

### Performance Steps

1. Check the DA Form 4678 against the medical officer's orders.
  - a. Name of the medication.
  - b. Amount (dose) of medication.
  - c. Route of administration.
  - d. Time to be administered.
2. Select the medication.
  - a. Check the medication label three times to ensure that the correct medication is being prepared for administration.
    - (1) First time-when removing the medication from the storage shelf.
    - (2) Second time-when preparing the medication dose.
    - (3) Third time-when returning the medication to the storage shelf.
  - b. Check the expiration date of the medication.
  - c. Handle only one medication at a time.

**NOTE:** If unfamiliar with a medication, look it up to determine contraindications, precautions, and side effects before preparing it for administration.

3. Prepare the prescribed dose of topical medication.
  - a. Obtain single dose packets of topical medication.
  - b. Obtain the required number of medicated patches or pads.
  - c. Apply the prescribed size ribbon of ointment to an application paper.
  - d. Obtain the jar or tube of medication identified for that individual patient's use.
  - e. Aseptically transfer the required amount of topical medication from the bulk storage container to a sterile, disposable container.
4. Place all the prepared medications on a tray or the medication cart.

**NOTE:** When preparing medication for more than one patient, mark the prepared medications with the patient's identification.

5. Correctly identify the patient and explain the procedure.
6. Don gloves.
7. Prepare the skin.
  - a. Provide privacy or screen the patient, as necessary.
  - b. Expose the prescribed area of the patient's skin.



- c. Clean the skin IAW the medical officer's orders, if required.
- 8. Apply the medication to the patient.
  - a. Locate the correct medication.
  - b. Apply the medication to the prescribed area IAW the medical officer's orders or local standard operating procedure.
    - (1) Secure patches, pads, and application paper with tape.
    - (2) Cover topical applications with sterile dressings IAW the medical officer's orders, if required.

*NOTE:* If a patient refuses the application of a medication, offer it again in five minutes. If refused a second time, record the omission on DA Form 4678, document the reason for the omission in the nursing notes and inform the nursing staff and/or medical officer.

- 9. Record the administration of all medications on the appropriate medical forms.

*NOTE:* Administration of all scheduled and nonscheduled (PRN) medications must be documented.

- a. Initial the DA Form 4678.
  - b. Make a nursing note entry describing the location of the application topical medication and the condition of the skin at the time of application.
  - c. Annotate the nursing notes when administering controlled drugs, nonscheduled (PRN) medications, and other medications as required by local policy.
    - (1) Name of the medication.
    - (2) Time the medication was administered.
    - (3) Reason for the medication.
- 10. Record the omission of a medication on the appropriate medical forms whenever a scheduled medication is not administered.
  - a. Annotate DA Form 4678 by placing a circle in the initial block.
  - b. Annotate the nursing notes.
    - (1) Name of the medication.
    - (2) Time it should have been administered.
    - (3) Reason it was not administered.
    - (4) Follow-up action taken.

**Evaluation Preparation:**

Setup: For training evaluation, this task is best performed utilizing another Soldier as the patient.

Brief Soldier: Tell the Soldier the simulated patient requires a medication to be topically administered.

<b>Performance Measures</b>	GO	NO GO
1 Checked DA Form 4678 against the medical officer's order.	_____	_____
2 Selected the medication.	_____	_____
3 Prepared the prescribed dose of topical medication.	_____	_____

<b>Performance Measures</b>	GO	NO GO
4 Placed the prescribed medications on a tray or the medication cart.	_____	_____
5 Identified the patient and explained the procedure.	_____	_____
6 Donned gloves.	_____	_____
7 Prepared the skin.	_____	_____
8 Applied the medication to the patient.	_____	_____
9 Recorded the administration of all medications on the appropriate medical forms.	_____	_____
10 Recorded the omission of a medication on the DA Form 4678 whenever a scheduled medication was not administered.	_____	_____

**Evaluation Guidance:** Score each Soldier according to the performance measures. Unless otherwise stated in the task summary, the Soldier must pass all performance measures to be scored GO. If the Soldier fails any steps, show what was done wrong and how to do it correctly.

**References**

**Required**  
DA Form 4678

**Related**  
None

**Subject Area 19: Force Health Protection**

**Disinfect Water for Drinking**

**081-831-0037**

**Conditions:** You are a member of a field sanitation team. You have just filled a lyster bag or water buffalo from a source that is not safe for drinking. You will need calcium hypochlorite, mess kit spoon, a canteen cup, and a field chlorination kit. You are not in a CBRN environment.

**Standards:** Disinfect water to a chlorine residual of 5 parts per million (ppm) or as ordered by the commander.

**Performance Steps**

1. Mix the stock disinfecting solution.
  - a. Add the prescribed dosage of calcium hypochlorite to 1/2 canteen cup of water.
    - (1) 3 ampules per 36 gallons of water.
    - (2) 22 ampules or 3 plastic meals ready to eat (MRE) spoonfuls (from a bulk container) in 400 gallons of water.
  - b. Stir the stock solution.
2. Add the stock solution to the water container.
  - a. Pour the stock solution into the water container.
  - b. Mix the solution vigorously with a clean implement.
  - c. Cover the container.
3. Flush the faucets.
4. Test the chlorine residual after 10 minutes.
  - a. Follow the manufacturer's instructions on the color comparator in the chlorination kit to test the chlorine residual.
  - b. Add more calcium hypochlorite as needed to maintain 5 ppm/mg/l.
  - c. Retest the chlorine residual after 20 minutes.
5. Retest the water two or three times daily.

**Evaluation Preparation:**

You must evaluate the students on their performance of this task in a field condition related to the actual task.

**Performance Measures**

	GO	NO GO
1 Mixed the stock disinfecting solution.	_____	_____
2 Added the stock solution to the water container.	_____	_____
3 Flushed the faucets.	_____	_____
4 Tested the chlorine residual after 10 minutes.	_____	_____
5 Retested the water two or three times daily.	_____	_____

**Evaluation Guidance:** Score each Soldier according to the performance measures in the evaluation guide. Unless otherwise stated in the task summary, the Soldier must pass all

performance measures to be scored GO. If the Soldier fails any step, show what was done wrong and how to do it correctly.

**References**

**Required**  
None

**Related**  
None

## Apply Restraining Devices to Patients

081-833-0076

**WARNING:** Restraints can cause numerous problems, including limited mobility, skin breakdown, impaired circulation, incontinence, psychological distress, and strangulation. Do not restrain a patient in the prone position. This position limits their field of vision, intensifies feelings of helplessness and impairs respiration, especially if the patient has been sedated.

**Conditions:** You have a patient that needs to be restrained. You will need a bed, restraints (limb, vest, or mitt, as needed), padding if needed, restraint flow sheet DA Form 4700 Medical Record-Supplemental Medical Data, flexible gauze (Kerlix/Kling), cravats, pen, SF 510 Nursing Notes, bed alarm if bed has one, minimum of three coworkers, and sheets. You are not in a CBRN environment.

**Standards:** Apply restraining devices to a patient without causing injury to the patient or yourself.

**NOTE:** Restraint is a method of physically restricting a person's freedom of movement, physical activity, or normal access to their body. This includes not only traditional restraints, such as limb restraints, but also tightly tucked sheets or the use of side rails to prevent a patient from getting out of bed.

### Performance Steps

1. Assess and verify the need for restraint usage.
  - a. Follow the Joint Commission (TJC) and central material service (CMS) standards for applying restraints.
  - b. Make sure that less-restrictive measures have been tried before applying restraints.
2. Obtain a written or verbal order from a medical officer for the restraints.
3. Tell the patient what you are about to do, and describe the restraints to them.

**NOTE:** Assure them that they're being used to protect them from injury, not to punish them.

4. Obtain adequate assistance if necessary to restrain the patient before entering their room.
  - a. Enlist the aid of several coworkers.
  - b. Organize their effort.
  - c. Give each person a specific task.

**WARNING:** Never secure restraints to the side rails because someone might inadvertently lower the rail before noticing the attached restraint. This may jerk the patient's limb or body, causing them discomfort and trauma.

**CAUTION:** Never secure all four restraints to one side of the bed because the patient may fall out of bed.

5. Apply restraining device to patient.

**NOTE:** Do not apply a limb restraint above an intravenous (IV) site because the constriction may occlude the infusion or cause infiltration into surrounding tissue.

- a. Limb restraint.
  - (1) Wrap the patient's wrist or ankle with a padded restraint.
  - (2) Pass the strap on the narrow end of the restraint through the slot in the broad end, and adjust for snug fit.

(3) Alternatively, fasten the buckle or Velcro cuffs to fit the restraint.

(4) You should be able to slip one or two fingers between the restraint and the patient's skin.

(5) Avoid applying the restraint too tightly because it may impair circulation distal to the restraint.

(6) Tie all restraints securely to the frame of the bed, chair, or wheelchair and out of the patient's reach.

**WARNING:** Never secure the restraint to a bedrail or other movable part of the equipment.

(7) Use a bow or knot that can be released quickly and easily in an emergency.

*NOTE:* Never tie a regular knot to secure the straps.

(8) Leave 1 inch to 2 inches (2.5 to 5 cm) of slack in the straps to allow room for movement.

(9) After application, be alert for signs of impaired circulation, movement, or sensation in the extremity distal to the restraint.

*NOTE:* Check skin color, condition, temperature and check pulse. If the restraints are too tight or the patient is complaining of numbness and tingling, loosen the restraints.

(10) Release the restraints every 2 hours to assess the skin and perform range of motion (ROM) exercises to stimulate circulation and prevent contractures and loss of mobility.

b. Vest restraint.

(1) Assist the patient to a sitting position if their condition permits.

(2) Slip the vest over their gown.

(3) Crisscross the cloth flaps at the front, placing the V-shaped opening at the patient's throat.

**WARNING:** Never crisscross the flaps in the back because this may cause the patient to choke if they try to squirm out of the vest.

(4) Pass the tab on one flap through the slot on the opposite flap.

(5) Adjust the vest for the patient's comfort.

(6) You should be able to slip your fist between the vest and the patient.

**CAUTION:** Avoid wrapping the vest too tightly because it may restrict respiration.

(7) Tie the restraint.

(8) After applying the vest, check the patient's respiratory rate and breath sounds regularly.

(9) Be alert for signs of respiratory distress.

(10) Make sure the vest has not tightened with the patient's movement.

(11) Loosen the vest frequently, if possible, so the patient can stretch, turn, and breathe deeply.

c. Mitt restraint.

(1) Wash and dry the patient's hands.

(2) Roll up a washcloth or gauze pad, and place it in the patient’s palm.

(3) Have the patient form a loose fist, if possible; then pull the mitt over it and secure the closure.

(4) To restrict the patient’s arm movement, attach the strap to the mitt and tie it securely, using a bow or a knot that can be released quickly and easily in an emergency.

**WARNING:** When using mitts made of transparent mesh, check hand movement and skin color frequently to assess circulation.

(5) Remove the mitts regularly to stimulate circulation, and perform passive ROM exercises to prevent contractures.

6. Inform the medical officer within 12 hours of placing the patient in restraints.

*NOTE:* The patient must be examined by the medical officer within 24 hours of the initiation of restraints.

7. Evaluate and assist the restrained patient IAW local facility policies.

a. If patient is at high risk of aspiration, ensure they are restrained on their side.

b. The restrained patient has limited mobility, therefore their nutrition, elimination and positioning becomes your responsibility.

c. Assess and monitor the condition of the restrained patient continually.

*NOTE:* Ensure skin color, condition, temperature and pulse are monitored continually. Loosen restraints per local standard operating procedures and perform range of motion exercises to keep patient’s circulation in tact and to avoid permanent injury.

8. Document the procedure on the DA Form 4700 and SF 510.

**Evaluation Preparation:**

Setup: For training and evaluation, use another Soldier to simulate a patient requiring restraints.

Brief Soldier: Tell the Soldier the simulated patient requires restraints to be applied. Use other Soldiers to assist you with this task.

<b>Performance Measures</b>	GO	NO GO
1 Assessed and verified the need for restraint usage.	_____	_____
2 Obtained a written or verbal order from a medical officer for the restraints.	_____	_____
3 Told the patient what you were about to do and described the restraints to them.	_____	_____
4 Obtained adequate assistance if necessary to restrain the patient before entering into the room.	_____	_____
5 Applied appropriate restraining device to patient.	_____	_____
6 Informed medical officer within 12 hours of placing the patient in restraints.	_____	_____
7 Evaluated and assisted the restrained patient IAW local facility policies.	_____	_____
8 Documented the procedure on the DA Form 4700 and SF 510.	_____	_____

**Evaluation Guidance:** Score each Soldier according to the performance measures. Unless otherwise stated in the task summary, the Soldier must pass all performance measures to be scored GO. If the Soldier fails any steps, show what was done wrong and how to do it correctly.

**References**

**Required**  
DA Form 4700  
SF 510

**Related**  
None



**Skill Level SL3**  
**Subject Area 20: Medical Treatment**  
**Perform a Digital Block Anesthesia**  
**081-833-0036**

**Conditions:** You have a patient who needs an anesthetic digital block. You will need 2% lidocaine solution without epinephrine, 3 to 5 ml syringe, 18 gauge needle, 23 gauge needle, alcohol pad and gauze pad, draping, sterile gloves and SF 600 (Medical Record - Chronological Record of Medical Care). You are not in a CBRN environment.

**Standards:** Perform an anesthetic digital block without causing injury to patient.

**Performance Steps**

1. Solicit a patient history.
2. Gather equipment.

*NOTE:* Local anesthetics are to be used without epinephrine in the digits to avoid vasoconstriction of adjacent arteries, which may lead to ischemia or infarction of local tissues.

3. Perform a patient care handwash.
4. Prepare an injection for administration. (See task 081-833-0088.)

*NOTE:* Prepare the injection by drawing up 3 milliliters of 2% lidocaine from the vial.

5. Put on gloves.
6. Prepare the site.
  - a. Position the patient with the effected digit easily accessible.
  - b. Clean the injection site at the base of the digit just above the bottom knuckle on both sides of the digit with an alcohol pad or antimicrobial solution.

*NOTE:* Do not touch the injection site after cleansing.

7. Perform the digital block anesthesia.
  - a. Insert the needle perpendicularly into the web space, at the base of the finger, just distal to the metacarpal-phalangeal joint.

*NOTE:* Be careful not to push the needle out of the bottom of the finger or through the volar aspect of the web space.

- b. Advance the needle into the layer of fat under the skin. This can easily be determined by the "give" you will feel when you have penetrated the skin.
- c. Inject about one milliliter of lidocaine into the fatty layer under the skin while withdrawing the needle back to the skin surface (the nerve you are numbing runs through this space and must be surrounded by lidocaine to prevent the transmission of nerve signals).
- d. Allow 10-20 minutes for the anesthetic to take effect.
- e. Repeat the procedure on the opposite side of the digit. Wait about five minutes and check the digit for sensation, (Pressure is a normal sensation but if any pain is felt, the process can be repeated with another milliliter of lidocaine on each side of the digit).
- f. All digits except the great toe can be effectively anesthetized in the same manner. The three-sided digital block technique is most effective on the great toe.

- (1) Place the patient's extremity plantar side down.

(2) Insert the needle at a 90-degree angle at the medial aspect of the digit, just distal to the metatarsal-phalangeal joint.

(3) Slowly inject the anesthetic as the needle is advanced toward the plantar side, without piercing the volar skin.

(4) Slowly withdraw the needle and redirect it medially.

(5) Advance the needle slowly from medial to lateral side while the anesthetic is injected.

(6) Withdraw the needle.

(7) Make another injection over the already anesthetized skin at the lateral aspect of the digit, with the needle at 90 degrees, advancing it from the dorsal to ventral aspect, as was done medially.

8. Remove gloves.

9. Document the procedure on SF 600.

a. Consent.

b. Description of the area of interest prior to performing the procedure.

c. Give a description of the procedure; to include the type and quantity of anesthesia used.

d. How the patient tolerated the procedure.

e. Any follow-up care or instructions given to the patient.

**Evaluation Preparation:**

This task is best evaluated by verbalization and demonstration of the steps. Give the Soldier a scenario in which he must perform a digital block.

<b>Performance Measures</b>	GO	NO GO
1 Solicited a patient history.	_____	_____
2 Gathered equipment.	_____	_____
3 Performed a patient care handwash.	_____	_____
4 Prepared the injection for administration.	_____	_____
5 Put on gloves.	_____	_____
6 Prepared the site.	_____	_____
7 Performed the digital block anesthesia.	_____	_____
8 Removed gloves.	_____	_____
9 Documented the procedure on SF 600.	_____	_____

**Evaluation Guidance:** Score each Soldier according to the performance measures in the evaluation guide. Unless otherwise stated in the task summary, the Soldier must pass all performance measures to be scored GO. If the Soldier fails any step, show what was done wrong and how to do it correctly.

**References**

**Required**  
SF 600

**Related**  
None

## Perform Suture Removal

**081-833-0026**

**Conditions:** You have a patient requiring suture removal and a medical officer's order. You will need a suture removal kit, 4 x 4 gauze, a patient drape, antiseptic cleaning solution, adhesive strips, cotton tipped applicator (CTA), and an emesis basin. You are not in a CBRN environment.

**Standards:** Remove sutures without reopening the wound site and causing further injury to the casualty.

### Performance Steps

1. Gather equipment.
2. Explain procedure to patient.
3. Take appropriate body substance isolation (BSI) precautions.
4. Clean the wound site.

*NOTE:* This should be done in order to remove any dried blood and crusting from wound.

- a. Drape patient as necessary.
  - b. Pour antiseptic cleaning solution into emesis basin.
  - c. Dip cotton tipped applicator (CTA) into solution.
  - d. Gently rub wound with cotton tipped applicator (CTA).
  - e. Repeat process until wound is generally free of blood and crusting.
5. Remove sutures.

*NOTE:* Patient may feel some slight pain or tingling at extraction site.

- a. Pick up first suture with forceps, cut with scissors and pull suture out of wound.
- b. Repeat process until all sutures have been removed.

*NOTE:* Large incisions will require removal of every other suture due to tension along incision site. Carefully inspect the wound edges after removal of each suture. If there is any evidence of the wound edges pulling apart, stop the procedure immediately and inform the medical officer.

6. Have medical officer inspect the wound site.

*NOTE:* Perform any additional care as directed by the medical officer.

7. Apply adhesive strips if directed by medical officer.
  - a. Open adhesive strip package.
  - b. Remove inner adhesive strip sheet.
  - c. Cut adhesive strip sheet to desired length.

*NOTE:* Adhesive strips should extend 1/2 to 1 inch on either side of wound.

- d. Apply adhesive to the noninjured area on opposing sides of the incision.
- e. Apply adhesive strips evenly over entire incision.

8. Document procedure per local SOP.

**Evaluation Preparation:** None.

<b>Performance Measures</b>	GO	NO GO
1 Gathered equipment.	_____	_____
2 Explained procedure to patient.	_____	_____
3 Took appropriate body substance isolation precautions (BSI).	_____	_____
4 Cleaned wound site.	_____	_____
5 Removed sutures.	_____	_____
6 Had medical officer inspect wound site.	_____	_____
7 Applied adhesive strips if directed by medical officer.	_____	_____
8 Documented procedure per local SOP.	_____	_____

**Evaluation Guidance:** Score each Soldier according to the performance measures in the evaluation guide. Unless otherwise stated in the task summary, the Soldier must pass all performance measures to be scored GO. If the Soldier fails any step, show what was done wrong and how to do it correctly.

**References**

**Required**  
None

**Related**  
None

## Establish a Sterile Field

**081-833-0007**

**Conditions:** You need to establish a sterile field. You will need sterile packs, sterile drapes and towels, a small solution basin, sterile liquids, sterile needles and syringes, sterile gloves, and a flat, clean, dry surface. You have performed a patient care handwash. You are not in a CBRN environment.

**Standards:** Establish a sterile field without violating aseptic technique.

### Performance Steps

1. Obtain sterile equipment and supplies IAW local SOP.
2. Select a flat, clean, dry surface.

*NOTE:* Choose a surface away from drafts, if possible.

3. Create a sterile field with a double-wrapped sterile package.
  - a. Lift the top flap of the sterile pack away from the body without crossing your hand or arm over the sterile field.
  - b. Lift the remaining flaps, one at a time, away from the center without crossing your hand or arm over the sterile field.
4. Introduce sterile items onto the sterile field.

*NOTE:* The outer two inch border of the sterile field is considered contaminated. Items that fall into that area are considered contaminated and should not be used. If an item rolls from the two inch border onto the sterile field, the sterile field is considered contaminated and the procedure must be stopped immediately and the procedure must be repeated using a new sterile pack.

- a. Commercially prepacked items (syringes, sutures, needles, etc.).
  - (1) Keeping your hands on the outside of the sterile wrapper, grasp the opening edge of the package.
  - (2) Carefully fold (roll) each end of the wrapper back toward your wrists.
  - (3) Without contaminating the contents, drop them onto the sterile field.

*NOTE:* If the wrapper has been punctured, torn, or has water marks, the item is no longer sterile.

- b. Centralized materiel service (CMS) items (wrapped in double muslin wrappers).
  - (1) Remove the outer wrapper.
  - (2) Grasp the edge of the item being unwrapped, keeping your hand on the outside of the inner wrapper.
  - (3) Fold each edge of the wrapper slowly back over your wrist of the hand holding the item.
  - (4) Drop the item onto the sterile field.

5. Open sterile liquids.

*NOTE:* 1. Liquids prepared in CMS are considered sterile if a vacuum release sound is heard when the bottle is opened. If there is no sound, the bottle is considered unsterile, and a new

bottle must be obtained before continuing the procedure. 2. Some commercially prepared bottles of sterile solution may not make a vacuum release sound.

- a. Remove the outer protective bottle seal, if necessary, and remove the cap.
- b. Hold the cap in one hand, or place the cap so the top rests on the table.

*NOTE:* The bottle rim and inside of the cap are considered sterile.

**CAUTIONS:** Discard the sterile solution under any of the following conditions: 1. Anyone touches the bottle rim. 2. The lip of the bottle touches non-sterile items. 3. Someone touches the inside of the cap or the part of the cap that touches the container is placed on the table.

6. Pour sterile liquids.
  - a. Hold the bottle with the label against your palm.
  - b. Pour a small amount of the liquid from the bottle into a waste receptacle.
  - c. Hold the bottle about 6 inches above the container into which the liquid is to be poured.
  - d. Slowly pour a steady stream to avoid splashing, thus preventing contamination.
  - e. Replace the cap without contaminating the bottle.
  - f. Write the date and time the bottle was opened and your initials on the label. Return the bottle to the storage area or discard it IAW local SOP.

*NOTE:* If the sterile field is contaminated at any time, the procedure must be stopped immediately. Repeat all steps using new sterile equipment.

7. Do not violate aseptic technique.

**Evaluation Preparation:**

Setup: Place all necessary materials and equipment including sterile packs, sterile drapes and towels, a small solution basin, sterile liquids, sterile needles and syringes, and sterile gloves on a table. Place another table adjacent to the first table for the sterile field. Have a waste receptacle in place to receive the sterile liquid poured.

<b>Performance Measures</b>	GO	NO GO
1 Obtained sterile equipment and supplies IAW local SOP.	_____	_____
2 Selected a flat, clean, dry surface.	_____	_____
3 Created a sterile field with a double-wrapped sterile package.	_____	_____
4 Introduced sterile items onto the sterile field.	_____	_____
5 Opened sterile liquids.	_____	_____
6 Poured sterile liquids.	_____	_____
7 Did not violate aseptic technique.	_____	_____

**Evaluation Guidance:** Score each Soldier according to the performance measures. Unless otherwise stated in the task summary, the Soldier must pass all performance measures to be scored a GO. If the Soldier fails any steps, show what was done wrong and how to do it correctly.

**References**

**Required**  
None

**Related**  
None

## Perform Staple Removal

**081-833-0027**

**Conditions:** You have a patient requiring staple removal and a medical officer's order. You will need a staple remover, 4 x 4 gauze, a patient drape, antiseptic cleaning solution, adhesive strips, cotton tipped applicator (CTA), and an emesis basin. You are not in a CBRN environment.

**Standards:** Remove staples without reopening the wound site and causing further injury to the casualty.

### Performance Steps

1. Gather equipment.
2. Explain procedure to patient.
3. Take appropriate body substance isolation (BSI) precautions.
4. Clean the wound site.

**NOTE:** This should be done in order to remove any dried blood and crusting from wound.

- a. Drape patient as necessary.
  - b. Pour antiseptic cleaning solution into emesis basin.
  - c. Dip cotton tipped applicator (CTA) into solution.
  - d. Gently rub wound with cotton tipped applicator (CTA).
  - e. Repeat process until wound is generally free of blood and crusting.
5. Remove staples.

**NOTE:** Patient may feel some slight pain or tingling at extraction site.

- a. Insert staple remover's lower jaw under the first staple.
- b. Depress remover handle until staple retracts from skin.

**NOTE:** Large incisions will require removal of every other staple due to tension along incision site. Carefully inspect the wound edges after removal of each staple. If there is any evidence of the wound edges pulling apart, stop the procedure immediately and inform the medical officer.

- c. Repeat process until all staples are removed.

6. Have medical officer inspect the wound site.

**NOTE:** Perform any additional care as directed by the medical officer.

7. Apply adhesive strips if directed by medical officer.
  - a. Open adhesive strip package.
  - b. Remove inner adhesive strip sheet.
  - c. Cut adhesive strip sheet to desired length.

**NOTE:** Adhesive strips should extend 1/2 to 1 inch on either side of wound.

- d. Apply adhesive to the noninjured area on opposing sides of the incision.
  - e. Apply adhesive strips evenly over entire incision.
8. Document procedure per local SOP.

**Evaluation Preparation:** None.

<b>Performance Measures</b>	<b>GO</b>	<b>NO GO</b>
1 Gathered equipment.	_____	_____
2 Explained procedure to patient.	_____	_____
3 Took appropriate body substance isolation precautions (BSI).	_____	_____
4 Cleaned wound site.	_____	_____
5 Removed staples.	_____	_____
6 Had medical officer inspect wound site.	_____	_____
7 Applied adhesive strips if directed by medical officer.	_____	_____
8 Documented procedure per local SOP.	_____	_____

**Evaluation Guidance:** Score each Soldier according to the performance measures in the evaluation guide. Unless otherwise stated in the task summary, the Soldier must pass all performance measures to be scored GO. If the Soldier fails any step, show what was done wrong and how to do it correctly.

**References**

**Required**  
None

**Related**  
None



## Perform Abscess Incision and Drainage

**081-833-0192**

**Conditions:** You have a patient with an abscess that needs incision and drainage (I&D). You will need povidone-iodine (1% betadine) antimicrobial solution, 10ml syringe, 25 gauge needle, 1/2 inch plain or iodoform sterile gauze packing, 4 x 4 inch sterile gauze sponge, adhesive tape, No. 11 or No. 15 scalpel blade with handle, hemostat (curved), tissue forceps, surgical scissors, cotton-tipped sterile applicators, gloves, a culture swab, draping, lidocaine and SF 600 (Medical Record-Chronological Record of Medical Care) and a patient consent form. You are not in a CBRN environment.

**Standards:** Perform an abscess I&D without causing further injury to the patient.

### Performance Steps

1. Solicit a patient history to assess if the abscess requires urgent attention (abscesses found on the extremities, buttocks, breast, perianal area, or those that occur from infected hair follicles).

*NOTE:* Smaller (<5mm in diameter) abscesses may resolve with conservative measures (warm soaks) to promote drainage. Larger abscesses will require incision to drain them. As the increased inflammation, pus collection and walling off of the abscess cavity diminishes, so does the effectiveness of conservative measures.

2. Gather equipment.
3. Perform a patient care handwash. (See task 081-831-0007.)
4. Put on sterile gloves. (See task 081-831-0008.)
5. Prepare the site.
  - a. Position the patient with the abscess easily accessible.
  - b. Prepare the abscess and surrounding area with the antimicrobial solution.
  - c. Apply sterile drapes to completely surround the abscess and to cover all unprepared areas adjacent to the abscess.
  - d. Perform a field block by anesthetizing the perimeter surrounding the abscess with 1%-2% lidocaine with epinephrine.

*NOTE:* Do not inject the anesthetic directly into the abscess because it will not be effective in the acidic medium.

- e. Hold the syringe parallel to the skin and insert a 25-gauge needle into the middle of the dome of the abscess so the needle is just slightly under the skin (the anesthetic will spread within the subcutaneous plane of the entire abscess).
  - f. Wait 2-3 minutes for the anesthetic to take effect.
6. Perform the incision, drainage, and packing of abscess.
  - a. Using the No. 11 or No. 15 blade, incise the abscess deeply from one side of the fluctuant area, to the opposite side of the fluctuant area. This is necessary to ensure complete evacuation of the purulent drainage.
  - b. Allow the material to drain, using the 4 x 4 gauze sponges to soak up any purulence and blood. Use the sterile cotton-tipped applicator to swab the inside of the abscess cavity for culture.

c. Use the hemostat, wrapped with gauze, to gently explore the abscess cavity and to break up any sacs or adhesions within the abscess.

*NOTE:* Do not use a gloved finger to break up loculations in an abscess that may contain a sharp or jagged foreign body.

d. Clean the cavity with 4-6 sterile cotton-tipped applicators soaked with 3% hydrogen peroxide. You may also irrigate the cavity with 0.9% normal saline solution under moderate pressure.

e. Loosely pack the abscess with 1/4 to 1 inch iodoform or plain sterile gauze packing allowing a small portion of the packing to protrude outside the cavity and dress the incision site with sterile gauze.

7. Remove gloves.

8. Document the procedure on SF 600.

a. Consent.

b. Description of the abscess prior to performing the procedure.

c. Give a description of the procedure (type and quantity of anesthesia used, length of incision, approximate amount of material exuded and culture if made).

d. Type of packing and dressing material.

e. How the patient tolerated the procedure.

f. Any follow-up care or instructions given to the patient.

(1) Stress the importance of keeping the area dry for the first 24 hours. Have the patient leave the packing in place and the initial dressing should not be disturbed until the following day. Elevate the affected extremity when possible.

(2) On the second day, the patient should remove the outside dressing, leaving the packing undisturbed and apply warm water compresses or submerge the site in a warm water bath for 20-30 minutes. This will hasten resolution of the inflammatory process and promote rapid healing.

(3) The patient should return as soon as possible if he develops a fever, if the area of erythema increases in size or if flu-like symptoms develop.

(4) The patient may require medications for pain (rarely) and possibly antibiotics.

9. Re-evaluate the patient in 24-72 hours after the I&D procedure.

*NOTE:* Most lesions are reevaluated 48 hours after the procedure; with the first packing change occurring at this time, if drainage is present, (facial abscesses should be reevaluated within 24 hours, after which, warm soaks should be started). Small abscesses can be cleaned with a cotton swab swirled in the cavity that is left open.

a. Perform a patient care handwash.

b. Put on gloves.

c. Remove the external dressing.

d. Gently remove the packing material from the abscess site.

e. Cleanse the abscess site with a sterile cotton-tipped applicator soaked in hydrogen peroxide 3%.

*NOTE:* Anesthesia is rarely necessary.

- f. Do not repack the cavity, especially if it is clean and pain and tenderness are significantly diminished.
- g. Re-apply a sterile dressing to the open abscess site.
- h. Remove gloves.
- i. Document your findings and any follow-on care plan on SF 600.

**Evaluation Preparation:**

This task is best evaluated by verbalization and demonstration of the steps. Give the Soldier a scenario in which he must perform an I&D of an abscess.

<b>Performance Measures</b>	GO	NO GO
1 Solicited a patient history.	_____	_____
2 Gathered equipment.	_____	_____
3 Performed a patient care handwash.	_____	_____
4 Put on sterile gloves.	_____	_____
5 Prepared the site.	_____	_____
6 Performed the incision, drainage, and packing.	_____	_____
7 Removed gloves.	_____	_____
8 Documented the procedure on SF 600.	_____	_____
9 Re-evaluated patient in 24-72 hours after the I&D procedure.	_____	_____

**Evaluation Guidance:** Score each Soldier according to the performance measures in the evaluation guide. Unless otherwise stated in the task summary, the Soldier must pass all performance measures to be scored GO. If the Soldier fails any step, show what was done wrong and how to do it correctly.

**References**

**Required**  
SF 600

**Related**  
None

## Subject Area 21: Trauma Treatment

### Suture a Laceration

#### 081-833-0071

**Conditions:** You have a casualty with a minor laceration requiring closure. The laceration does not involve the face, hands, feet, or genitalia. You will need sterile suture set, appropriate type and size of suture, staples, skin adhesive, steri strips, lidocaine 1% with and without epinephrine, saline irrigation solution, antiseptic solution, sterile gloves, antibiotic ointment, sterile dressing, and SF 600 (Medical Record-Chronological Record of Medical Care). You are not in a CBRN environment.

**Standards:** Properly clean, anesthetize, and suture the laceration without causing further harm.

#### Performance Steps

1. Prepare the site. (See task 081-833-0087.)
2. Anesthetize the area. (See task 081-833-0090.)
3. Select the method of closure.

##### a. Skin adhesive.

(1) Hold the wound edges together and slightly everted with tissue forceps.

(2) Apply adhesive with the applicator tip by lightly wiping along the long axis of the wound.

**NOTE:** Three to four thin layers should be applied successively. Avoid droplets or a single thick layer.

(3) Hold the wound edges together for approximately 1 minute.

(4) Instruct the casualty not to apply ointment or dressing to the wound.

##### b. Steri strips.

(1) Apply benzoin to a 2 to 3 cm area beyond the wound edges. Do not allow benzoin to enter the wound.

(2) Using forceps, attach the strip to the skin on one side and then pull the steri strip across the wound to close the wound edges.

(3) Start in the center and progress toward each end. Leave some space between individual strips.

(4) Instruct the casualty not to get the area wet.

##### c. Staples.

(1) Hold the wound edges together with tissue forceps.

(2) Place the stapling device gently against the skin surface.

(3) Slowly squeeze the trigger.

(4) Evenly place only the necessary amount of staples to close the wound.

**NOTE:** There is little to no benefit to locally infiltrating an area for one to two staples to be placed. The anesthetic is more discomforting than the procedure.

##### d. Suture.

(1) Select the proper size and type of material.

(2) Check for adequate anesthesia by grasping the wound edges with tissue forceps. Note if the casualty can feel pain.

(3) Grasp the needle with the needle holder about 1/2 to 1/3 the distance from where the suture is attached.

(4) Hold the needle holder in the palm, using the index finger for fine control.

(5) Enter the skin at approximately a 90 degree angle on the far side of the wound and exit on the near side.

*NOTE:* You should enter and exit the skin about 2 mm from the edge. Entry and exit points should be directly across from each other.

(6) Pull the suture through the wound until approximately a 2 cm tail remains on the far side of wound.

(7) Hold the end of the suture attached to the needle in the non-dominant hand.

(8) Hold the needle holder in the dominant hand.

(9) Loop the suture twice around the needle holder.

(10) Grasp the free end of the suture with the blades of the needle holder.

(11) Cross the hands so that the hand holding the swaged end is on the far side and the hand holding the needle holder and free end are on the near side of the wound.

(12) Pull upward on the suture ends when clinching the first throw.

(13) Adjust the tension of the first throw so that the wound edges come together snugly but not tightly.

(14) For the second throw of the knot, the needle end is on the far side of the wound and the free end on the near side.

(15) Hold the needle end of the suture in the non-dominant hand and lay the needle holder on top.

(16) Loop the suture only once around the needle holder.

(17) Grasp the free ends with the blades of the holder.

(18) Cross the hands so that the sutures smoothly intertwine.

**CAUTION:** Take care not to cinch down too tightly on the second throw because the tightness will be transmitted to the wound.

(19) Cinch down the throw.

(20) Pull the knot to the side so that it will not directly overlie the laceration.

(21) The pattern of looping the suture around the holder on alternate sides of the wound is repeated until the desired number of throws are completed.

(22) Cut the ends of the suture material to approximately 3 to 5 cm length.

4. Apply antibiotic ointment to the site.

5. Apply a sterile dressing to the site.

6. Remove gloves.

7. Document the procedure on SF 600.

**Evaluation Preparation:**

Setup: For training and evaluation, use a simulation device that accepts different types of suturing to be performed on it.

Brief Soldier: Tell the Soldier the simulated patient requires a laceration to be sutured.

<b>Performance Measures</b>	GO	NO GO
1 Prepared the site.	_____	_____
2 Anesthetized the area.	_____	_____
3 Selected the method of closure and sutured the laceration.	_____	_____
4 Applied antibiotic ointment.	_____	_____
5 Applied a sterile dressing.	_____	_____
6 Removed gloves.	_____	_____
7 Documented the procedure on SF 600.	_____	_____

**Evaluation Guidance:** Score each Soldier according to the performance measures. Unless otherwise stated in the task summary, the Soldier must pass all performance measures to be scored GO. If the Soldier fails any steps, show what was done wrong and how to do it correctly.

**References**

**Required**  
SF 600

**Related**  
Textbook of Basic Nursing

## Prepare Suture Site

**081-833-0087**

**Conditions:** You have a patient requiring sutures. You will need, PPE (personal protective equipment), trash receptacle with biohazard bag in place for contaminated or bloody/blood soaked waste materials, waterproof pads (chux), gauze (4 x 4 or 4 x 8) squares, sterile normal saline solution or sterile water solution, betadine swabs, antiseptic soap solution, surgical drape, tape, bandage scissors, patient's chart, pen, gloves, and SF 510 Nursing Notes. You are not in a CBRN environment.

**Standards:** Prepare suture site without causing injury to patient.

*NOTE:* Check expiration dates on items.

### Performance Steps

1. Assemble all needed items.
2. Explain the procedure to the patient and ask about allergies.

*NOTE:* Ask the patient about drug, betadine/povidone-iodine/cleanser and adhesive/tape allergies.

3. Take and record patient's vital signs.
4. Provide privacy for the patient.
  - a. Ask patient to remove necessary clothing.
  - b. Have patient put on disposable gown.
  - c. Place belongings in a safe place.
  - d. Assist patient getting into bed or on a litter if needed.
5. Assist the patient into the appropriate position for skin prep of the suture site.
  - a. Have patient tell and show you the suture site area.
  - b. Place the patient in a comfortable position.
  - c. Drape the patient appropriately.
  - d. Expose the preparation area.

*NOTE:* For most suture sites, this area extends 12 inches (30.5cm) in each direction from the expected suture site.

- (1) Assess the patient's skin condition in the preparation area.
- (2) Report and document on SF 510:
  - (a) Rash in the area.
  - (b) Abrasion(s) in the area.
  - (c) Color (i.e. redness).
  - (d) Condition (i.e dirt, debris, warm to touch).
  - (e) Drainage (i.e. purulent, greenish or yellowish).
  - (f) Odor (i.e. foul smelling).

e. Position a chux (waterproof pad) beneath the patient to catch spills and avoid linen changes.

f. Adjust the light to illuminate the preparation area.

6. Position receptacle with biohazard bag within reach to dispose of contaminated waste materials.

7. Put on personal protective equipment (PPE) and sterile gloves.

8. Arrange the instruments and other sterile items in the order that the medical officer will use them.

*NOTE:* Do not reach, cough, sneeze, wave, talk or cross over the sterile field or it can become contaminated. Carefully cover the sterile field with a sterile towel until the medical officer is ready to begin.

9. Remove hair from the suture site, as indicated per medical officer's orders.

*NOTE:* Perform this procedure as near to the time of suturing as possible so that microorganisms will have minimal time to proliferate.

10. Proceed with a 10 minute scrub to ensure a clean preparation area.

a. Wash the area with a guaze pad dipped in the antiseptic soap solution.

*NOTE:* Use a benzalkonium chloride antiseptic cleaning agent solution, in case the patient has an allergy to betadine or iodine.

b. Using a circular motion, start at the suture site and work outward toward the periphery of the area to avoid recontaminating the clean area.

c. Apply light friction while washing to improve the antiseptic effect of the solution.

d. Replace the gauze pads as necessary.

11. Remove gloves, discard in the biohazard container and wash hands.

12. Inform the medical officer that the suture site is ready for suturing.

13. Document the procedure on SF 510.

**Evaluation Preparation:**

Setup: For training and evaluation, use a Soldier as a simulated patient.

Brief Soldier: Tell the Soldier the simulated patient has a laceration that requires suturing.

<b>Performance Measures</b>	GO	NO GO
1 Assembled all needed items.	_____	_____
2 Explained procedure to patient and asked about allergies.	_____	_____
3 Took and recorded patient's vital signs.	_____	_____
4 Provided privacy for the patient.	_____	_____
5 Assisted the patient into the appropriate position for skin prep of the suture site.	_____	_____
6 Positioned receptacle with biohazard bag within reach to dispose of contaminated waste materials.	_____	_____
7 Put on PPE and sterile gloves.	_____	_____



<b>Performance Measures</b>	GO	NO GO
8 Arranged the instruments and other sterile items in the order that the medical officer will use them.	_____	_____
9 Removed hair from the suture site, as indicated per medical officer's orders.	_____	_____
10 Proceeded with a 10 minute scrub to ensure a clean preparation site.	_____	_____
11 Removed gloves, discarded in biohazard container and washed hands.	_____	_____
12 Informed the medical officer that the suture site was ready for suturing.	_____	_____
13 Documented the procedure on the SF 510.	_____	_____

**Evaluation Guidance:** Score each Soldier according to the performance measures. Unless otherwise stated in the task summary, the Soldier must pass all performance measures to be scored GO. If the Soldier fails any steps, show what was done wrong and how to do it correctly.

**References**

**Required**  
SF 510

**Related**  
None

## Apply Local Anesthesia

081-833-0090

**Conditions:** You have a patient requiring local anesthesia. You will need the ordered anesthetic, sterile needle and syringe, patient's chart, pen, and sterile gloves. You are not in a CBRN environment.

**Standards:** Apply local anesthesia without causing injury to the patient.

### Performance Steps

1. Prepare the site. (See task 081-833-0087.)
2. Anesthetize the area.
  - a. Cryoanesthesia.
    - (1) Apply a moistened ice cube to the skin for about 5 minutes.
    - (2) Spray the area with commercial refrigerants, as directed.
  - b. Topical applications.
    - (1) Apply the agent directly to the mucus membrane, serous surface, or onto the open wound.
    - (2) Slightly saturate a gauze with the appropriate agent and place it on the wound for 5 to 10 minutes.
    - (3) Check the area for tissue blanching which indicates adequate anesthesia.
  - c. Simple infiltration.
    - (1) Ensure the casualty does not have an allergy to the agent.
    - (2) Using a needle and syringe, draw up an adequate amount of 1% lidocaine.
3. Document the procedure on SF 510.

**WARNING:** Lidocaine with epinephrine is never used on the tip of the nose, ears, fingers, toes or genitalia due to vasoconstriction.

- (3) The anesthetic solution is injected near the wound edge extending approximately 1 cm around the wound margin.
- (4) Aspirate prior to injecting the solution to ensure the needle is not in a vessel. (If blood returns into the syringe, withdraw, change the needle, and try a new site.
- (5) Slowly inject solution beneath the skin surface, raising a wheal in the area to be anesthetized.
- (6) Repeat steps 2c(3) through 2c( 5) depending on the size of the laceration.

### Evaluation Preparation:

Setup: For training and evaluation, use a simulation device capable of having anesthesia administered and sutures placed.

Brief Soldier: Tell the Soldier the simulated patient has a laceration that requires local anesthesia to be administered.

**Performance Measures**

	GO	NO GO
1 Prepared the site.	_____	_____
2 Anesthetized the area.	_____	_____
3 Documented the procedure on SF 510.	_____	_____

**Evaluation Guidance:** Score each Soldier according to the performance measures. Unless otherwise stated in the task summary, the Soldier must pass all performance measures to be scored GO. If the Soldier fails any steps, show what was done wrong and how to do it correctly.

**References****Required**

None

**Related**

SF 510

## Subject Area 22: Airway Management

### Insert a Chest Tube

081-833-0168

**Conditions:** You have a casualty suffering from a hemothorax or pneumothorax who requires the insertion of a chest tube. You will need a chest tube (16-36 French), sterile gloves, one-way valve, scalpel handle and blades (No. 10 and No. 15), Kelly forceps, large hemostat, betadine solution, suture material (size 0 silk), lidocaine 1% for injection, needle, syringe, and DD Form 1380 US Field Medical Card (FMC). You are not in a CBRN environment.

**Standards:** Insert a chest tube without causing further injury to the casualty.

#### Performance Steps

1. Explain the procedure to casualty if the casualty is conscious.
2. Record baseline vital signs and respiratory assessment.
3. Prepare the casualty.
  - a. Position the casualty appropriately.
  - b. Raise the arm on the affected side above the casualty's head.
  - c. Select the insertion site at the anterior axillary line over the 4th or 5th intercostal space.

*NOTE:* Identify safe triangle and insertion site, 5th intercostal space in the midaxillary line. The point of insertion in the chest most commonly occurs on the side (lateral thorax), at a line drawn from the armpit (anterior axillary line) to the side (lateral) of the nipple in males, or to the side (about 2 to 5 cm) above the sternoxiphoid junction (lower junction of the sternum, or chest bone) in females.

- d. Cleanse the site with antiseptic solution.
- e. Put on sterile gloves.
- f. Drape the area.
- g. Liberally infiltrate the area with the 1% lidocaine solution.

*NOTE:* Keep the total amount of Lidocaine used below 0.5 mL/kg (milliliters/kilogram), (5 milligrams/kilograms).

- h. Make an incision into the skin that is parallel to the rib.

*NOTE:* Incision should be 2 to 3 centimeters (cm) transverse incision over the selected site and extend it down to the intercostal muscles and 1 to 2 cm below the interspace through which the tube will be placed.

4. Insert the tube.
  - a. Insert the Kelly forceps through the intercostal muscles in the next intercostal space.

**CAUTION:** Avoid puncturing the lung. Always use the superior margin of the rib to avoid the intercostal nerves and vessels.

- b. Puncture the parietal pleura with the tip of the forceps and slightly enlarge the hole by opening the clamp 1.5 to 2 cm.

- c. Immediately insert a gloved finger into the pleural cavity to clear any adhesions, clots, etc.

d. Grasp the tip of the chest tube with Kelly forceps. Insert the tip of the tube in the incision as you withdraw your finger.

e. Advance the tube until the last side hole is 2.5 to 5 cm inside the chest wall.

*NOTE:* Advance insertion of tube until the pleural cavity is reached. Drain insertion and positioning (aim apically for the pneumothorax or basally for hemothorax (fluid)).

f. Connect the end of the tube to a one-way drainage valve (e.g., Heimlich valve).

g. Secure the tube using the suture materials.

h. Apply an occlusive dressing.

*NOTE:* Open the packages containing the petroleum gauze, 4 x 4 drain dressings, and gauze pads, then place the petroleum gauze and two 4 x 4 drain dressings around the insertion site, one from the top and the other from the bottom. Place several 4 x 4 gauze pads on top of the drain dressings. Tape the dressings, covering them completely to form an occlusive dressing.

i. Check the status of the drainage tubing.

j. Radiograph the chest to confirm placement, if available.

5. Reassess the casualty.

a. Check for bilateral breath sounds.

b. Monitor and record vital signs every 15 minutes.

6. Document the procedure on an FMC.

**Evaluation Preparation:**

Setup: For training and evaluation, use a simulation device capable of having a chest tube inserted.

Brief Soldier: Tell the Soldier a simulated patient requires a chest tube to be inserted.

<b>Performance Measures</b>	GO	NO GO
1 Explained the procedure to casualty if the casualty is conscious.	_____	_____
2 Recorded baseline vital signs and respiratory assessment.	_____	_____
3 Prepared the casualty.	_____	_____
4 Inserted the tube.	_____	_____
5 Reassessed the casualty.	_____	_____
6 Documented the procedure on an FMC.	_____	_____

**Evaluation Guidance:** Score each Soldier according to the performance measures in the evaluation guide. Unless otherwise stated in the task summary, the Soldier must pass all performance measures to be scored GO. If the Soldier fails any step, show what was done wrong and how to do it correctly.

**References**

**Required**  
DD Form 1380

**Related**  
None

## Insert an Endotracheal Tube

081-833-0100

**Conditions:** You have an unconscious, non-breathing casualty with no gag reflex in a field environment. You will need an assistant, batteries (appropriate for laryngoscope size), laryngoscope with blades (straight and curved, sizes 1-4), extra light bulb for laryngoscope blade, endotracheal tube (7 mm), bag-valve-mask, nonsterile gloves, suction equipment, pulse oximeter, 10 cc syringe, 1/2 inch adhesive tape, scissors, stethoscope and a DD Form 1380 US Field Medical Card (FMC) or DA Form 7656 Tactical Combat Casualty Care Card (TCCC). You are not in a CBRN environment.

**Standards:** Insert an endotracheal (ET) tube in the airway and verify tube placement by checking for bilateral breath sounds.

### Performance Steps

1. Put on gloves.
2. Open the airway manually.
3. Elevate the tongue, insert simple airway adjunct (either oropharyngeal airway (OPA) or nasopharyngeal airway (NPA)).
4. Ventilate casualty with a bag-valve-mask device.
5. Attach oxygen reservoir to bag-valve-mask device and connect to high-flow regulator (12-15 lpm if available).
6. Ventilate casualty at a rate of 10-12/minute.
7. Direct assistant to pre-oxygenate casualty.
8. Inspect and prepare equipment for intubation, (laryngoscope, ET tube, stylet).
  - a. Attach the laryngoscope blade to the laryngoscope.
    - (1) Hook the blade to the connector on the top of the laryngoscope.
    - (2) Lift the blade at a 90 degree angle to lock the blade in place.
  - b. Select the appropriate size of ET tube for the casualty (average adult male-8.0-8.5 cm; average adult female - 7.0-7.5 cm).
  - c. Fill the 10 cubic centimeter (cc) syringe with air and attach the syringe to the ET tube cuff valve (pilot balloon), inflate the cuff, and inspect for leaks.

*NOTE:* If you detect a leak, discard ET tube in trash container and get a new one.
  - d. Deflate cuff by pulling back on the plunger until all the air is out.
  - e. Insert stylet into ET tube.
    - (1) The stylet should be inserted into the ET tube so the tip of the stylet is recessed ½ inch from the tip of the ET tube.
    - (2) Bend the other end of the stylet at a 90 degree angle to prevent it from going further into the ET tube.
9. Position the casualty's head by hyperextending the neck.

*NOTE:* This will allow for visualization of the vocal cords.

10. Open the casualty's mouth and hold it open by pushing down on the jaw. Remove the airway adjunct.
11. Insert the laryngoscope blade into mouth and visualize vocal cords.
  - a. Stand or kneel at the top of the casualty's head.
  - b. Hold the laryngoscope with your left hand.
  - c. Open and lock the blade at a 90 degree angle.
  - d. Place the blade into the right side of the casualty's mouth.
  - e. Move the laryngoscope to the center of the mouth by sliding the laryngoscope to the left side of the mouth; this will in turn move the patient's tongue out of the way.
  - f. Advance the blade a short distance to observe the epiglottis.
  - g. Retract the epiglottis and observe the vocal cords.
    - (1) If using a Macintosh blade (curved), apply anterior pressure to the vallecula with the tip of the laryngoscope blade. This will fold back the epiglottis and expose the vocal cords.
    - (2) If using a Miller blade (straight), hook the blade tip under the epiglottis and pull up to fold back the epiglottis and expose the vocal cords.
12. Insert the ET tube into the trachea.
  - a. Grasp the ET tube with your right hand.
  - b. Carefully guide the tip of the tube between the vocal cords until the cuff is just below the level of the vocal cords.
13. Remove the laryngoscope from the airway.
14. Remove the stylet from the ET tube.
15. Inflate the cuff of the ET tube by injecting the required amount of air (5 to 10 cc) to create seal by pressing the plunger of the syringe.
16. Check placement of the ET tube.
  - a. Instruct assistant to auscultate the casualty's lung fields and epigastric area while you manually ventilate the casualty.
  - b. If casualty has strong bilateral breath sounds and no sounds of air movement are heard over the epigastric area, proceed to step 17.
  - c. If sound is heard over one lung field only, you must partially deflate the cuff, withdraw the ET tube slightly, reinflate the cuff, and listen again.
  - d. If a rushing sound is heard over the epigastric area, and breath sounds are not heard, deflate the cuff, withdraw the ET tube completely, reoxygenate the casualty, and repeat procedure.
17. Secure the ET tube with 1/2 inch adhesive tape.
18. Manually ventilate casualty.
19. Discard trash and gloves in trash can.
20. Perform a patient care hand wash.
21. Record procedure on FMC or TCCC Card.

**Evaluation Preparation:**

Setup: For training and evaluation, use a simulation device that allows endotracheal intubation.

Brief Soldier: Tell the Soldier the simulated patient requires an endotracheal tube to be inserted.

<b>Performance Measures</b>	<b>GO</b>	<b>NO GO</b>
1 Put on gloves.	_____	_____
2 Opened the airway manually.	_____	_____
3 Elevated the tongue and inserted a simple airway adjunct.	_____	_____
4 Ventilated the patient with a bag-valve-mask.	_____	_____
5 Attached oxygen reservoir to bag-valve-mask device and connected to high-flow regulator.	_____	_____
6 Ventilated casualty at a rate of 10-12 per minute.	_____	_____
7 Directed assistant to pre-oxygenate casualty.	_____	_____
8 Inspected and prepared equipment for intubation.	_____	_____
9 Positioned casualty's head.	_____	_____
10 Opened the casualty's mouth.	_____	_____
11 Inserted the laryngoscope blade into mouth and visualized vocal cords.	_____	_____
12 Inserted the ET tube into the trachea.	_____	_____
13 Removed the laryngoscope from the casualty's airway.	_____	_____
14 Removed the stylet from the ET tube.	_____	_____
15 Inflated the cuff of the ET tube.	_____	_____
16 Checked placement of the ET tube.	_____	_____
17 Secured the ET tube with ½ inch adhesive tape.	_____	_____
18 Manually ventilated the casualty.	_____	_____
19 Discarded trash and gloves in trash can.	_____	_____
20 Performed a patient care hand wash.	_____	_____
21 Recorded procedure on FMC or TCCC Card.	_____	_____

**Evaluation Guidance:** Score each Soldier according to the performance measures in the evaluation guide. Unless otherwise stated in the task summary, the Soldier must pass all performance measures to be scored GO. If the Soldier fails any step, show what was done wrong and how to do it correctly.

**References**

**Required**  
DA Form 7656  
DD Form 1380

**Related**  
None



## Subject Area 23: Venipuncture and IV Therapy

### Administer Blood

#### 081-835-3000

**Conditions:** You have verified a medical officer's order requiring the administration of blood. You have identified the patient and explained the procedure. A patient care handwash has been performed. You will need a blood pack with SF 518 (Medical Record - Blood or Blood Component Transfusion), thermometer, blood pressure cuff, stethoscope, blood transfusion recipient set ("Y" type), intravenous (IV) stand, tourniquet, needle and syringe, IV catheter, tape, alcohol and betadine prep pads, gloves, a container of 0.9% normal saline for injection, and the patient's clinical records. You are not in a CBRN environment.

**Standards:** Administer the blood IAW the medical officer's orders and without causing injury to the patient.

#### Performance Steps

1. Verify and inspect the blood pack received from the laboratory.

a. Note the time the blood pack was received and record the time on the SF 518.

*NOTE:* Infusion of a blood pack should be initiated within 30 minutes of being issued.

b. Two people must verify and match the information on the blood pack label with the data on the requisition form (SF 518).

*NOTE:* One of the verifiers must be a Registered Nurse when directed by local policy.

c. Inspect the blood for abnormalities such as gas bubbles or black or gray colored sediment (indicative of bacterial growth).

*NOTE:* Return the blood pack to the blood bank if any abnormality is present or suspected.

d. Match the blood pack with the patient's identification.

(1) The same two people must compare the information on the blood unit with the data on the patient's wristband. Ensure the patient's name, blood type, and hospital number positively match the data on the blood pack.

(2) Sign the SF 518 IAW local policy when all the data has been confirmed as a positive match.

2. Establish baseline data.

a. Reconfirm data from the patient's history regarding allergies or previous reactions to blood or blood products.

b. Measure and evaluate the vital signs.

c. Record the vital signs on the SF 518 and in the nursing notes.

3. Prepare the blood and the blood recipient set.

*NOTE:* Use only tubing that is designed for the administration of blood products. It is equipped with a filter designed for the fine filtration required for blood products.

a. Close all three clamps on the "Y" tubing.

b. Aseptically insert one of the tubing spikes into the container of normal saline. Invert and hang this container about 3 feet above the level of the patient.

c. Open the clamp on the normal saline line and prime the upper line and the blood filter.

d. Open the clamp on the empty line on which you will eventually hang the blood.

Normal saline will flow up the empty line to prime that portion of the tubing.

**NOTE:** Use only 0.9% normal saline for injection with blood. Other solutions are not compatible.

- e. Once the blood line is primed with saline, close the clamp on the blood line.
- f. Leave the clamp on the normal saline line open.
- g. Open the main roller clamp to prime the lower infusion tubing.
- h. Close the main roller clamp.
- i. Aseptically expose the blood port on the blood pack.
- j. Aseptically insert the remaining spike into the blood port and hang the blood at the same level as the normal saline container.

**NOTE:** If Y type recipient tubing is not available, use regular infusion tubing for the normal saline and the available blood recipient tubing for the blood pack. Prime each set. Attach a sterile, large bore (16 or 18 gauge) needle to the end of the blood tubing and piggyback the blood into the normal saline line below the level of the roller clamp. Hang the blood pack at least 6 inches higher than the normal saline.

4. Perform the venipuncture. (See task 081-833-0033.)

**NOTE:** Insert a large gauge IV catheter (14, 16, or 18) for administering blood to an adult patient. This will enhance the flow of blood and prevent hemolysis of the cells.

5. Begin the infusion of blood.
  - a. Attach the primed infusion set to the catheter, tape it securely, and open the main roller clamp.

**NOTE:** If a preexisting catheter is being used, run in 50 cc of normal saline to flush out any incompatible solution. If a new catheter was inserted, this step is not required.

- b. Close the roller clamp to the normal saline and open the roller clamp to the blood.
- c. Adjust the flow rate with the main roller clamp.

(1) Set the flow rate to deliver approximately 10 to 25 cc of blood over the first 15 minutes.

**NOTE:** When delivering blood by piggyback, begin the infusion by opening the roller clamp on the normal saline line and setting it to keep open (TKO) rate. Adjust the roller clamp on the blood line to deliver 10 to 25 cc of blood over the first 15 minutes.

**CAUTION:** Any time an adverse reaction is suspected, immediately stop the blood and infuse normal saline. Notify the charge nurse and medical officer immediately.

(2) Monitor the vital signs closely for the first 15 minutes and observe for indications of an adverse reaction to the blood.

(3) Set the main roller clamp to deliver the prescribed flow rate if, after the first 15 minutes, no adverse reaction is suspected and the vital signs are stable.

**NOTE:** Use the correct formula to calculate flow rate. (See Figure 3-18.)

$$\text{gtt/min} = \frac{\text{volume to be infused X gtt/cc of administration set}}{\text{infusion time in minutes}}$$

Figure 3-18. IV Flow rate calculation

6. Monitor and evaluate the patient throughout the procedure.
  - a. Monitor vital signs every hour or more frequently IAW local SOP.
  - b. Compare the vital signs with previous and baseline vital signs.
  - c. Observe for changes that indicate an adverse reaction to the blood.

**CAUTION:** When a transfusion reaction occurs or is suspected, the unused blood and recipient tubing must be sent to the laboratory along with a 10 ml specimen of the patient's venous blood and a post transfusion urine specimen.

- d. Stop the blood, infuse normal saline, and notify the charge nurse and medical officer if a reaction is suspected.

7. Discontinue the infusion of blood.

- a. When the blood pack has emptied, close the clamp to the blood and open the clamp to the normal saline.

- b. Flush the tubing and filter with approximately 50 cc of normal saline to deliver the residual blood.

- c. After the residual blood has been delivered, run the normal saline at a TKO rate or hang another solution, if one has been prescribed.

- d. Take and record the vital signs at the completion of the transfusion and 1 hour after completion.

*NOTE:* As a rule, a unit of blood should be infused within 2 to 4 hours unless contraindicated by risk of circulatory overload. If the prescribed flow rate will deliver the blood within a shorter or longer period of time, verify the order with the charge nurse or prescribing medical officer.

8. Dispose of the used blood pack IAW local SOP.

- a. Return it to the laboratory blood bank with a copy of SF 518.
  - b. Discard it in a container for contaminated waste.

9. Document the procedure and significant nursing observations on the appropriate forms IAW local SOP.

- a. Complete the SF 518.

- (1) Return one copy to the laboratory blood bank.

(2) Place one copy in the patient's chart.

b. Record the procedure and the patient's response in a nursing note entry.

**Evaluation Preparation:** None.

<b>Performance Measures</b>	GO	NO GO
1 Verified and inspected the blood pack.	_____	_____
2 Established baseline data.	_____	_____
3 Prepared the blood and blood recipient sets.	_____	_____
4 Performed the venipuncture.	_____	_____
5 Began the infusion of blood.	_____	_____
6 Monitored and evaluated the patient.	_____	_____
7 Discontinued the infusion of blood.	_____	_____
8 Disposed of the used blood pack IAW local SOP.	_____	_____
9 Documented the procedure on the appropriate forms IAW local SOP.	_____	_____

**Evaluation Guidance:** Score each Soldier according to the performance measures. Unless otherwise stated in the task summary, the Soldier must pass all performance measures to be scored GO. If the Soldier fails any steps, show what was done wrong and how to do it correctly.

**References**

**Required**  
SF 518

**Related**  
Textbook of Basic Nursing  
Techniques in Clinical Nursing: Basic to Intermediate Skills

## Administer Blood Products

**081-835-3054**

**Conditions:** Your assigned patient has an order requiring the administration of a specific blood product. You will need the prescribed blood component, appropriate administration set, clean gloves, the patient's medical record, and SF 518 (Medical Record-Blood or Blood Component Transfusion). You are not in a CBRN environment.

**Standards:** Safely and correctly administer a prescribed blood component.

### Performance Steps

1. Verify the medical officer's order and ensure the patient has a current signed informed consent for transfusion.

**CAUTION:** The administration of blood and blood products is generally outside the scope of practice of the 68WM6 Practical Nurse. Administration of blood and blood products is restricted to the domain of a medical officer. However, this task is an expected skill of the 68WM6 Practical Nurse in a combat field environment.

2. Review the procedure for administering a blood transfusion. (See task 081-835-3000.)
3. Obtain the blood component from the blood bank.
4. Obtain the appropriate administration set.
5. Review the directions and facility protocol for administration of the blood product.
  - a. Rate of administration.
  - b. Route.
  - c. Risk factors.
  - d. Possible complications.
6. Obtain a positive identification of the patient and provide privacy.
7. Wash your hands and follow standard precautions.
8. Explain the procedure to the patient/family.
9. Administer the prescribed blood product.

**NOTE:** When using an infusion control device (pump), review the manufacturer's instructions for use to ensure you are using the correct pump, configured correctly, with the proper tubing and filter.

- a. Fresh plasma-rapid administration with straight line administration set.
- b. Platelets-administer at a rate of 10 minutes per unit, using the platelet infusion set and filter.
- c. Granulocytes-slow administration over 2 to 4 hours with Y-type blood tubing and normal saline. Do not use a microaggregate filter.
- d. Serum albumin-slow administration at 1 ml/min using the special tubing supplied with the solution.
- e. Gamma globulin-given IM 0.25 to 0.5 ml.
- f. Coagulation factors-administer with standard syringe or component drip set.
  - (1) Factor VIII-1 unit/5 min.

(2) Factor IX-reconstitute 10 to 20 ml of diluent.

10. Monitor the patient for unexpected outcomes and report abnormal findings to the medical officer.

11. Conduct patient education based on specific patient needs.

12. Document the nursing activity.

a. Type and amount of blood product administered.

b. Volume of saline or diluent used.

c. Patient's response to the procedure.

d. Unexpected outcomes and interventions.

e. Patient education provided.

**Evaluation Preparation:** None.

<b>Performance Measures</b>	<b>GO</b>	<b>NO GO</b>
1 Verified the medical officer's order and the presence of a current signed informed consent.	_____	_____
2 Reviewed the procedure for administering a blood transfusion.	_____	_____
3 Obtained the prescribed blood component from the blood bank.	_____	_____
4 Obtained the correct administration set.	_____	_____
5 Reviewed the directions and facility protocol for administration of the blood product.	_____	_____
6 Obtained positive patient identification and provided privacy.	_____	_____
7 Washed hands and followed standard precautions.	_____	_____
8 Explained the procedure to the patient/family.	_____	_____
9 Correctly administered the prescribed blood product.	_____	_____
10 Monitored the patient for unexpected outcomes and reported abnormal findings to the medical officer.	_____	_____
11 Provided patient education based on individual needs.	_____	_____
12 Documented the nursing activity.	_____	_____

**Evaluation Guidance:** Score each Soldier according to the performance measures in the evaluation guide. Unless otherwise stated in the task summary, the Soldier must pass all performance measures to be scored GO. If the Soldier fails any step, show what was done wrong and how to do it correctly.

**References**

**Required**  
SF 518

**Related**  
Procedure Manual for Critical Care  
Clinical Nursing Skills: Basic to Advanced Skills

## Remove an EZ Intraosseous Device

**081-833-0236**

**Conditions:** You have a medical officer's order to discontinue (DC) a patient's EZ intraosseous (IO) device. You will need disposable gloves, alcohol or povidone-iodine wipes, scissors, sterile 2 x 2 gauze, sterile 10cc syringe, adhesive bandage, waterproof pad (chux), pen, puncture-resistant biohazard (sharps) container, biohazard contamination bag, and SF 510 Nursing Notes. You have performed a patient care hand wash and you are not in a CBRN environment.

**Standards:** Remove an EZ IO device without causing harm or injury to the patient.

*NOTE:* Do not leave an EZ IO device in for more than 24 hours or in accordance with (IAW) medical officer's order.

### Performance Steps

1. Place receptacle with biohazard contamination bag within easy access.
2. Put on personal protective equipment (PPE) and take body substance isolation (BSI) precautions.

*NOTE:* At a minimum, eye protection and gloves should be worn. Use a gown and shoe covers if needed.

3. Place waterproof pad (chux) underneath extremity where insertion site is located.
4. Stabilize patient's extremity.
5. Turn off the source of fluid and medication if applicable.
  - a. Ensure that the clamps controlling the IV fluid and extension set are clamped off.
  - b. Disconnect the IV line with extension set attached.
6. Remove EZ IO catheter.
  - a. Rotate catheter clockwise while pulling straight back.

**WARNING:** Do not rock or bend catheter during removal.

- b. Continuously rotate clockwise while slowly and gently applying traction to catheter.
- c. When catheter has been removed, immediately place in appropriate biohazard (sharps) container.
- d. Discard all soiled/contaminated materials in biohazard contamination bag.
7. Dress site as appropriate, IAW local standard operating procedure (SOP) and policies.
8. Remove PPE and BSI, discard and perform handwashing IAW local facility's protocol and infection control guidelines.
9. Document procedure on SF 510.

### Evaluation Preparation:

Setup: For training and evaluation, utilize a simulation device that will accept an EZ IO device being placed and removed. For EZ IO removal, place an EZ IO device into the simulator.

Brief Soldier: Tell the Soldier that the casualty requires his EZ IO device to be removed.

<b>Performance Measures</b>	GO	NO GO
1 Placed receptacle with biohazard contamination bag within easy access.	_____	_____
2 Put on PPE and took BSI precautions.	_____	_____
3 Placed waterproof pad (chux) underneath extremity where insertion site is located.	_____	_____
4 Stabilized patient's extremity.	_____	_____
5 Turned off source of fluid and medication (if applicable).	_____	_____
6 Removed EZ IO catheter.	_____	_____
7 Dressed site as appropriate.	_____	_____
8 Removed PPE and BSI, discarded and performed handwashing IAW local facility's protocol and infection control guidelines.	_____	_____
9 Documented procedure on SF 510.	_____	_____

**Evaluation Guidance:** Score each Soldier according to the performance measures. Unless otherwise stated in the task summary, the Soldier must pass all performance measures to be scored GO. If the Soldier fails any steps, show what was done wrong and how to do it correctly.

**References**

**Required**  
SF 510

**Related**  
None



## Initiate an EZ Intraosseous Device

**081-833-0237**

**WARNING:** It is contraindicated for fracture of the tibia or femur, previous orthopedic procedures, i.e. knee replacement, any infection over the insertion site, the inability to locate the anatomical landmarks, and excessive tissue over the insertion, intraosseous (IO) in the past 24 hours, prosthetic limb or joint.

**Conditions:** You have a medical officer's order for intraosseous access along with patient's clinical records. You have verified the physician's order and the patient. You have performed a patient care handwash. You will need an EZ (IO) driver, EZ IO cartridge, alcohol prep pads, betadine/iodine prep pads, waterproof pads (chux), 10cc sterile syringe, sterile NS flush, Intravenous (IV) pole, IV fluid (Normal Saline or Lactated Ringers), IV tubing administration set, a sharps container, Luer lock extension set, gauze pads 2 x 2's, biohazard bag, pressure infuser, pen and SF 510 Nursing Notes. You are not in a CBRN environment.

**Standards:** Initiate an EZ Intraosseous device without causing harm or injury to the patient.

### Performance Steps

1. Provide privacy for the patient.
2. Put on gloves and personal protective equipment (PPE).
  - a. Eye protection.
  - b. Gown.
  - c. Shoe covers, if needed.
3. Locate proper site for EZ IO insertion.

**NOTE:** The provider identifies the insertion site and landmarks.

- a. Anterior tibia.

**NOTE:** For tibial insertion, the insertion site is usually located at the anterior-medial distal tibia. For pediatric patients, the insertion site is the anterior-medial proximal tibia just below the tibial tuberosity.

- b. Distal tibia.
- c. Proximal humerus (used in adult patients only).

4. Assemble IV infusion fluid and tubing using aseptic technique. (See task 081-833-0033.)
5. Clean the insertion site using aseptic technique.
6. Prepare the EZ IO driver and needle set.
  - a. Remove the driver and one EZ IO cartridge from the case.
  - b. Open the EZ IO cartridge and attach the needle set to the driver, (you should feel a 'snap' as the small magnet connects).

**NOTE:** Ensure that the driver and needle set are securely seated.

- c. Remove the needle set from the cartridge.

**NOTE:** Only handle needle set by the plastic hub.

- d. Remove and discard the safety cap from the needle set.
- e. Remove the cap by momentarily powering the driver while holding the cap.

**NOTE:** This will break the 'seal' and allow you to remove the cap once the driver and needle set have stopped turning.

7. Insert EZ IO needle set.

a. Holding the driver in your dominant hand, stabilize the leg near the insertion site with your non-dominant hand.

**NOTE:** Control the patient's movement prior to and during needle insertion.

b. Position the driver at the insertion site with the needle at a 90 degree angle to the surface of the bone.

c. Gently power or press needle set until needle set tip touches bone.

**WARNING:** Do not use excessive force. Allow the needle set rotation and gentle downward pressure to provide the penetrating action.

**CAUTION:** Make sure the driver is maintained at a 90 degree angle at all times.

d. Penetrate bone cortex by squeezing the driver's trigger and applying gentle, steady, downward pressure.

e. Release driver's trigger and stop insertion process when a sudden "give" or "pop" will be felt upon entry into the medullary space or when the desired depth is obtained.

**NOTE:** If the driver stalls and will not penetrate the bone, you may be applying too much downward pressure. In the unlikely event of a driver failure, remove the power driver, grasp the needle set by your dominant hand and advance the needle set into the medullary space while twisting the needle set.

8. Stop when the needle flange touches the skin or a sudden decrease in resistance is felt.

9. Remove the power driver and stylet.

a. While grasping the hub gently with non-dominant hand, unscrew the stylet with dominant hand, counter clockwise from the catheter and place it in a sharps container.

b. Do not replace or attempt to 'recap' the stylet.

10. Confirm catheter stability.

**WARNING:** Do not attach a syringe directly to the EZ IO catheter hub when drawing blood for laboratory analysis, with the needle set stabilized.

11. Attach the extension set to the EZ IO hub.

12. Attach the syringe with the saline to the extension set.

a. Open the clamp on the extension set.

**CAUTION:** Do not aspirate marrow past the extension set 90 degree elbow, as occlusion may occur.

b. Draw back with the syringe plunger slightly, looking for fluid from the marrow cavity to mix with the saline.

c. "Dry" taps are not uncommon.

d. Inject 5 to 10 ml of the saline, observing for signs of infiltration.

e. If there are no signs of infiltration, clamp extension tubing and remove the syringe.

- f. Attach the IV tubing, open clamps on extension tubing and set the flow rate per physician's orders.
- g. Secure the needle and IV tubing.
- 13. Apply dressing and EZ IO wristband.
- 14. Discard all contaminate waste in biohazard bag in accordance with (IAW) local standard operating procedure (SOP) and infection control guidelines.
- 15. Clean and disinfect power driver according to manufacturer's guidelines.
- 16. Remove and discard gloves and PPE IAW local SOP.
- 17. Perform a patient care handwash.
- 18. Document procedure on SF 510.

**Evaluation Preparation:**

Setup: For training and evaluation, use a simulation device capable of accepting an EZ IO device  
 Brief Soldier: Tell the Soldier the simulated casualty requires an EZ IO device to be placed in a lower extremity.

<b>Performance Measures</b>	GO	NO GO
1 Provided privacy for the patient.	_____	_____
2 Put on gloves and PPE.	_____	_____
3 Located proper site for EZ IO insertion.	_____	_____
4 Assembled IV infusion fluid and tubing using aseptic technique. (See task 081-833-0033)	_____	_____
5 Cleaned the insertion site using aseptic technique.	_____	_____
6 Prepared the EZ IO driver and needle set.	_____	_____
7 Inserted the EZ IO needle set.	_____	_____
8 Stopped when the needle flange touches the skin or a sudden decrease in resistance is felt.	_____	_____
9 Removed the power driver and stylet.	_____	_____
10 Confirmed catheter stability.	_____	_____
11 Attached the extension set to the EZ IO hub.	_____	_____
12 Attached the syringe with the saline to the extension set.	_____	_____
13 Applied dressing and EZ IO wristband.	_____	_____
14 Discarded all contaminate waste in biohazard bag in accordance with (IAW) local standard operating procedure (SOP) and infection control guidelines.	_____	_____
15 Cleaned and disinfected power driver according to manufacturer's guidelines.	_____	_____
16 Removed and discarded gloves and PPE.	_____	_____
17 Performed a hand wash.	_____	_____

**Performance Measures**

GO      NO GO

18 Documented procedure on SF 510.      \_\_\_\_\_

**Evaluation Guidance:** Score each Soldier according to the performance measures. Unless otherwise stated in the task summary, the Soldier must pass all performance measures to be scored GO. If the Soldier fails any steps, show what was done wrong and how to do it correctly.

**References**

**Required**  
SF 510

**Related**  
None

**Subject Area 24: Triage and Evacuation**  
**Coordinate Casualty Treatment and Evacuation**  
**081-833-0227**

**Conditions:** You are deployed to a unit in a forward area. There are casualties that must be treated and evacuated to receive medical aid. You will need a military vehicle (ground vehicle or rotary-wing aircraft), litters, and straps (or materials to improvise them). You are not in a CBRN environment.

**Standards:** Ensure that medical and/or self-aid/buddy aid is provided to the casualties, as appropriate. Ensure that the casualties are transported to medical aid or to a pickup site using an appropriate carry or, if other Soldiers are available, by litter. Ensure that the litters are properly loaded onto a military vehicle (ground vehicle or rotary-wing aircraft) without dropping or causing further injury to the casualties.

**Performance Steps**

1. Evaluate the casualties according to the tactical situation. (See task 081-833-0281.)

*NOTE:* Tactical combat casualty care (TC-3) can be divided into three phases.

- \* Care under fire-you are under effective hostile fire and are very limited as to the care you can provide.
- \* Tactical field care-you and the casualty are relatively safe and no longer under effective hostile fire, and you are free to provide casualty care to the best of your ability.
- \* Tactical evacuation care-care is rendered during casualty evacuation (CASEVAC).

2. Coordinate treatment of the casualties according to the tactical situation and available resources.

3. Request medical evacuation (MEDEVAC). (See task 081-831-0283.)

- a. Make contact.

- b. Determine whether casualties must be moved or will be picked up at the current location. If they must be moved, continue with step 4. If they will not be moved, continue to monitor communications and go to step 6.

4. Move a casualty, if necessary, using a four-man litter squad.

*NOTE:* If military vehicles and litter materials are not available, continue with step 5.

*NOTE:* Four-man litter squad bearers should be designated with a number from 1 to 4. The litter bearer designated as #1 is the leader of the squad.

- a. Prepare the litter.

- (1) Open a standard litter.

- (2) Lock the spreader bars at each end of the litter with your foot.

- b. Prepare the casualty.

- (1) Place the casualty onto the litter.

- (2) Secure the casualty to the litter with litter straps.

- c. Lift the litter.

- (1) Position one squad member at each litter handle with the litter squad leader at the casualty's right shoulder.

*NOTE:* The leader should be at the right shoulder to monitor the casualty's condition.

(2) On the preparatory command, "Prepare to lift," the four bearers kneel beside the litter and grasp the handles.

(3) On the command, "Lift," all bearers rise together.

(4) On the command, "Four man carry, move," all bearers walk forward in unison.

(a) If the casualty does not have a fractured leg, carry the casualty-

\* Feet first on level ground.

\* Head first when going uphill.

(b) If the casualty has a fractured leg, carry the casualty-

\* Head first on level ground.

\* Feet first when going uphill.

5. Coordinate transportation of casualties using appropriate carries, if necessary.

6. Coordinate loading of casualties onto a military vehicle.

a. Ground ambulance.

*NOTE:* Ground ambulances have medical personnel to take care of the casualties during evacuation. Follow any special instructions for loading, securing, or unloading casualties.

(1) Secure each litter casualty to his litter.

(2) Load the most serious casualty last.

(3) Load the casualty head first (head in the direction of travel) rather than feet first.

(4) Secure each litter to the vehicle.

b. Air ambulance.

*NOTE:* Air ambulances have medical personnel to take care of the casualties during evacuation. Follow any special instructions for loading, securing, or unloading casualties.

(1) Secure each litter casualty to his litter.

(2) Remain 50 yards from the helicopter until the litter squad is signaled to approach the aircraft.

(3) Approach the aircraft in full view of the aircraft crew, maintaining visual confirmation that the crew is aware of the approach of the litter party. Ensure that the aircrew can continue to visually distinguish friendly from enemy personnel at all times. Maintain a low silhouette when approaching the aircraft.

(4) Approach UH-60/UH-1 aircraft from the sides. Do not approach from the front or rear. If you must move to the opposite side of the aircraft, approach from the side to the skin of the aircraft. Then, hug the skin of the aircraft, and move around the front of the aircraft to the other side.

(5) Load the most seriously injured casualty last.

(6) Load the casualty who will occupy the upper berth first, then load the next litter casualty immediately under the first casualty.

*NOTE:* This is done to keep the casualty from accidentally falling on another casualty if his litter is dropped before it is secured.

(7) When casualties are placed lengthwise, position them with their heads toward the direction of travel.

(8) Secure each litter to the aircraft.

(9) After loading the casualty onto the aircraft, the litter squad departs at the same time as one unit.

c. Ground military vehicles.

*NOTE:* Nonmedical military vehicles may be used to evacuate casualties when no medical evacuation vehicles are available.

*NOTE:* FM 4-02.2 (Medical Evacuation) contains suggested loading plans for many common nonmedical vehicles. You should become familiar with the plans for vehicles assigned to your unit.

(1) When loading casualties into the vehicle, load the most seriously injured casualty last.

(2) When a casualty is placed lengthwise, load the casualty with his head pointing forward, toward the direction of travel.

(3) Secure each litter casualty to his litter.

(4) Secure each litter to the vehicle as it is loaded into place.

(5) Watch the casualties closely for life-threatening conditions and provide treatment, as necessary, during CASEVAC.

*NOTE:* CASEVAC refers to the movement of casualties aboard nonmedical vehicles or aircraft. Care is rendered while the casualty is awaiting pickup or is being transported. A Soldier accompanying an unconscious casualty should monitor the casualty's airway, breathing, and bleeding.

**Evaluation Preparation:**

Setup: Evaluate this task during a training exercise involving a MEDEVAC aircraft or vehicle, or simulate it by creating a scenario, and provide the equipment needed for the evaluation.

Brief Soldiers: Tell the Soldier the scenario to include the end result desired.

<b>Performance Measures</b>	GO	NO GO
1 Evaluated the casualties according to the tactical situation.	_____	_____
2 Coordinated treatment of the casualties according to the tactical situation and available resources.	_____	_____
3 Requested medical evacuation.	_____	_____
4 Moved a casualty using a four-man litter squad, if necessary.	_____	_____
5 Coordinated transportation of casualties using appropriate carries, if necessary.	_____	_____
6 Coordinated loading of casualties onto a military vehicle.	_____	_____

**Evaluation Guidance:** Score each Soldier according to the performance measures. Unless otherwise stated in the task summary, the Soldier must pass all performance measures to be scored GO. If the Soldier fails any steps, show them what was done wrong and how to do it correctly.

STP 8-68W13-SM-TG

**References**

**Required**

None

**Related**

FM 4-02.2

STP 21-1-SMCT



**Subject Area 25: Medication Administration**  
**Administer Medication Through Endotracheal Tube**  
**081-833-0309**

**Conditions:** You have a medical officer's order to give medication via an endotracheal tube (ET). You will need an end-tidal carbon dioxide (CO<sub>2</sub>) detection device or esophageal detection device, handheld resuscitation bag, prescribed medication, syringe or adapter, sterile water or normal saline solution, pen, DA Form 4678 Therapeutic Documentation Care Plan, patient's clinical record, and SF 510 Nursing Notes. You have verified the medical officer's order, the medication (using the six rights) and the patient. You have performed a patient care hand wash and taken body substance isolation (BSI) precautions. You are not in a CBRN environment.

**Standards:** Administer medication through an endotracheal tube, using aseptic technique and without causing harm/injury to the patient.

**Performance Steps**

**WARNING:** Before injecting any drug, check proper placement of the ET tube, using an end-tidal CO<sub>2</sub> detector or an esophageal detection device.

1. Explain procedure and provide privacy for patient.

*NOTE:* In an emergency, some drugs may be given through an ET tube, if intravenous (IV) access is not available. They may be given using the syringe method or adapter method.

2. Position patient in the supine position.

*NOTE:* Make sure their head is level with or slightly higher than their trunk.

3. Ventilate the patient.

*NOTE:* Three to five times with the resuscitation bag and then remove the bag.

4. Administer medication.

- a. Syringe method.

- (1) Remove the needle before injecting medication into the ET tube.

- (2) Insert the tip of the syringe into the ET tube and inject the drug deep into the tube.

- b. Adapter method.

*NOTE:* An adapter for ET drug administration provides a more closed system of drug delivery than the syringe method.

- (1) A special adapter placed on the end of the ET tube allows needle insertion and drug delivery through the closed stopcock.

**WARNING:** Beware that the drug's onset of action may be quicker than it would be by IV administration.

**CAUTION:** Potential complications of ET drug administration results from the prescribed drug, not the administration route.

- (2) After injecting the drug, reattach the resuscitation bag and ventilate the patient briskly.

*NOTE:* This propels the drug into the lungs, oxygenates the patient and clears the tube.

5. Discard syringe in an appropriate sharps container.

6. Document the procedure on SF 510.

- a. Date of administration.

- b. Time of administration.
- c. Route of administration.
- d. Name of medication administered.
- e. Amount of medication given.
- f. Patient's response to procedure.

**Evaluation Preparation:**

Setup: For training and evaluation, use an airway manikin to be the simulated patient. Use 0.9% normal saline for the medication to be administered.

Brief Soldier: Tell the Soldier the simulated patient requires medication to be given via ET tube.

<b>Performance Measures</b>	<b>GO</b>	<b>NO GO</b>
1 Explained procedure and provided privacy for patient.	_____	_____
2 Positioned patient in the supine position.	_____	_____
3 Ventilated the patient.	_____	_____
4 Administered medication.	_____	_____
5 Discarded syringe in an appropriate sharps container.	_____	_____
6 Documented the procedure on SF 510.	_____	_____

**Evaluation Guidance:** Score each Soldier according to the performance measures. Unless otherwise stated in the task summary, the Soldier must pass all performance measures to be scored GO. If the Soldier fails any steps, show what was done wrong and how to do it correctly.

**References**

**Required**  
DA Form 4678  
SF 510

**Related**  
None

**GLOSSARY****Section I****Acronyms & Abbreviations**

AED	automatic external defibrillator
ATNAA	antidote treatment, nerve agent, autoinjector
AVPU	alertness, responsiveness to vocal stimuli, responsiveness to painful stimuli, unresponsiveness
BAS	battalion aid station; Bradley Acquisition System
BDO	battle dress overgarment; blanket delivery order
BDU	battle dress uniform
BSA	body surface area
BSI	body substance isolation; Base Support Installation
BVM	bag-valve-mask
C-A-T	combat application tourniquet
CAM	chemical agent monitor; computer aided manufacturing; camera; Content-Addressable Memory; crisis action module
CANA	convulsant antidote for nerve agent
CASEVAC	casualty evacuation
CBRN	chemical, biological, radiological, and nuclear
CC	cubic centimeter
CCP	casualty collection point;communications checkpoint
cGy	centigray
CM	centimeter(s)
CMS	central material service
CO2	carbon dioxide
CPR	cardiopulmonary resuscitation
CSF	cerebrospinal fluid
CTA	cotton tipped applicator
DA FORM	Department of the Army Form
DCAP-BTLS	deformities, contusions, abrasions, punctures or penetration, burns, tenderness, lacerations, and swelling
EKG	electrocardiogram/electrocardiograph
EPW	enemy prisoner of war
ETD	emergency trauma dressing

F	fahrenheit
FAS	Foreign Agricultural Service (USDA); frequency assignment subcommittee; fueling at sea; functional account symbol; forward aid station
FM	field manual
FMC	full mission-capable; field medical card
FROPVD	flow-restricted oxygen-powered ventilation device
HEPA	high efficiency particle air filter
HTH	high test hypochlorite
I&O	intake and output
IAW	in accordance with
ICS	Incident Command System; intercostal space; internal communications system; inter-service chaplain support
ID	identification; infantry division; internal diameter; intradermal; interface device; Identifier
IM	intramuscular
IV	intravenous
JSLIST	joint service lightweight integrated suit technology
JVD	jugular vein distention
KED	Kendrick Extrication Device
KVO	keep the vein open
L/min	liters per minute
LCE	load-carrying equipment; logistics capability estimator
LCV	load-carrying vest
LOC	line of communications; level of consciousness
LPM/lpm	liters per minute
MCL	mission configured load; midclavicular line
MDI	metered dose inhaler
MEDEVAC	medical evacuation
MES	medical equipment set(s)
MOI	message of interest; Material of Interest; memorandum of instruction; mechanism of injury
MOPP	mission-oriented protective posture
MTF	medical treatment facility
NAAK	nerve agent antidote kit
NATO	North Atlantic Treaty Organization

NBC	nuclear, biological, and chemical
NG	Nitroglycerin; National Guard; nasogastric
NPA	nasopharyngeal airway
NPO	nothing by mouth
OPA	oropharyngeal airway
OSHA	Occupational Safety and Health Administration
PASG	pneumatic anti-shock garments
PMS	pulse, motor function, and sensation
PPE	protective posture equipment; personal protective equipment
PVC	premature ventricular contraction
RN	registered nurse
RTO	radio/telephone operator
SMCT	Soldier's Manual of Common Tasks
SOAP	subjective, objective, analysis, plan
SOI	signal operating/operation instructions
SOP	standing operating procedure
SSN	social security number
STAT	immediately
STB	supertropical bleach; Special Troops Battalion
STP	Soldier's Training Publication
SURG	surgeon
SpO2	blood oxygen saturation
TBSA	total body surface area
TCCC	Tactical combat casualty care
TIC	toxic industrial chemical; tenderness, instability, or crepitus
TKO	to keep open
TRD	tenderness, rigidity, and distension; Transition Director
TSOP	tactical standing operating procedure
US	United States; ultrasound
WP	white phosphorus; work package
cc/hr	cubic centimeters of fluid per hour
cm	centimeter
cont	continued; continuous; continuous fire; controlled substance
g*	gram

STP 8-68W13-SM-TG

gtts	drops
kg	kilogram(s)
mg	milligram(s)
min(s)	minute(s)
ml or mL	milliliter
mm Hg	millimeters of mercury
mm/sec	millimeters per second
pnt	patient
prn	as necessary
psi	pounds per square inch

## Section II

### Terms

HD	symbol for distilled Levinstein mustard, a blister agent; hemostatic dressing; high definition
METT-TC	A memory aid used in two contexts: (1) In the context of information management, the major subject categories into which relevant information is grouped for military operations: mission, enemy, terrain and weather, troops and support available, time available, civil considerations. (2) In the context of tactics, the major factors considered during mission analysis. [ <i>NOTE</i> : the Marine Corps uses METT-T: mission, enemy, terrain and weather, troops and support available-time available.] (FM 6-0)
Psi	The amount of pressure exerted on one square inch of surface often stated as PSIA, or PSIG, signifying absolute or gauge pressure

**This page intentionally left blank.**



## REFERENCES

New reference material is being published all the time. Present references, as listed below may become obsolete. To keep up-to-date, see DA Pam 25-30. Many of these publications and forms are available in electronic format from the sites listed below:

Army Publishing Directorate

Administrative Departmental Publications and Forms  
(ARs, Cirs, Pams, OFs, SFs, DD & DA Forms)

Soldier's Training Homepage – RDL Services

Army Doctrinal and Training Publications  
(FMs, PBs, TCs, STPs)

Related publications are sources of additional information. They are not required in order to understand this publication.

### Army Regulations

AR 40-66	Medical Record Administration and Health Care Documentation, 17 June 2013.
AR 600-63	Army Health Promotion, 7 May 2007.

### Department of Army Forms

DA FORM 2028	Recommended Changes to Publications and Blank Forms
DA FORM 3949	Controlled Substances Record
DA FORM 4678	Therapeutic Documentation Care Plan (Medication).
DA FORM 4700	Medical Record – Supplemental Medical Data
DA FORM 7656	Tactical Combat Casualty Care (TCCC) Card

### Field Manuals

FM 4-02.2	Medical Evacuation, 8 May 2007.
FM 4-02.285	Multiservice Tactics, Techniques, and Procedure for Treatment of Chemical Agent Casualties and Conventional Military Chemical Injuries, 18 September 2007.
FM 4-02.4	Medical Platoon Leader's Handbook Tactics, Techniques, and Procedures, 29 August 2001.
FM 4-02.6	The Medical Company, Tactics, Techniques, and Procedures, 1 August 2002.
FM 4-25.11	First Aid, 23 December 2002.
FM 4-25.12	Unit Field Sanitation Team, 25 January 2002.
FM 8-10-6	Medical Evacuation in a Theater of Operations Tactics, Techniques, and Procedures, 14 April 2000.

### Army Tactics, Techniques Procedures

ATTP 4-02	Army Health System, 7 October 2011.
-----------	-------------------------------------

### Other Product Types

DD Form 1380	US Field Medical Card
DD Form 792	Twenty-Four Hour Patient Intake and Output Worksheet

SF 510 Medical Record - Nursing Notes  
SF 518 Medical Record - Blood or Blood Component Transfusion  
SF 600 Medical Record - Chronological Record of Medical Care  
OF 520 Medical Record - Electrocardiographic Record

**Special Texts**

- ISBN 0-13-119265-5 *EMT Complete: A Basic Worktext* by Le Baudour, Chris, Batsie, Daniel, Dickinson, Edward T., and Limmer, Daniel J. (Sep 16, 2006)
- ISBN 0-13-508579-9 *Prehospital Emergency Care, 9<sup>th</sup> Edition, Instructor's Wraparound Edition* By Alexander, Melissa and Werman, Howard A (2010)
- ISBN 0-323-06503-0- *PHTLS Prehospital Trauma Life Support (NAEMT PHTLS, Basic and Advanced Prehospital Trauma Support)* by NAEMT (Dec 7, 2010)
- ISBN 0-7637-4738-6 *AAOS Emergency Care and Transportation of the Sick and Injured, Ninth Edition* by American Academy of Orthopaedic Surgeons (Mar 2005)
- ISBN 0-7817-1636-5 *Rosdahl, Textbook of Basic Nursing, 7<sup>th</sup> Edition*, Lippincott, Williams & Wilkins (Oct 1999)
- ISBN 0-0706-5351-8 *Emergency Medicine: A Comprehensive Study Guide, 6<sup>th</sup> Edition*, by Judith E. Tintinalli, J. Stephan Stapczynski and Gabor D. Kelen (Sep 30, 1999)
- ISBN 0721682685-AACN *Procedure Manual for Critical Care, 4<sup>th</sup> Edition*, by Debra J. Lynn-McHale Wiegand Ph.D, R.N., CCRN, FAAN and Karen K. Carlson, R.N., MN, CCNS (Jan 15, 2001)
- 081-MEV1 *Physics in Nuclear Medicine: Expert Consult – Onlines and Print, 4e* By Simon R. Cherry, PhD, James A. Sorenson, PhD, and Michael E. Phelps, PhD (Apr 26, 2012)
- ISBN 0071484809 *Emergency Medicine, A Comprehensive Study Guide, Seventh Edition (Book and DVD) (Emergency Medicine (Tintinalli))* by Judith Tintinalli, J. Stapczynski, O. John Ma and David Cline (Oct 22, 2010)
- 6-8-C40(68W)(RMH) Ranger Medic Handbook
- ISBN 978-0781765213 *Textbook of Basic Nursing, 9<sup>th</sup> Edition*, Caroline Bunker Rosdahl, and Mary T. Kowalski
- ISBN 978-1-61669-040-3 *American Heart Association BLS for Healthcare Providers Instructor Manual Package* by Aha (Mar 1, 2011)
- ISBN 978-1416036234 *Clinical Procedures in Emergency Medicine: Expert Consult, 5<sup>th</sup> by James R. Roberts, M.D., and Jerris R. Hedges, M.D., M.S. (Oct 20, 2009)*
- B00010VX4G *Field Management of Chemical Casualties Handbook*. Aberdeen Proving Ground, MD., USA: U.S. Army Medical Research Institute of Chemical Defense (USAMRICD), Chemical Casualty Care Division, United States of America
- BERHOW, R (16) *The Merck Manual of Diagnosis and Therapy, 16th Edition*; Merck Company
- CDC WEBSITE *The Centers for Disease Control and Preventio* ([www.cdc.org](http://www.cdc.org))
- DUELL, MARTIN, & SMITH *Clinical Nursing Skills: Basic to Advanced Skills, 5th Edition*, Prentice Hall (ISBN: 0838515665)

- HABIF, T. P. Clinical Dermatology, by Thomas P. Habif, M.D. (Dec 9, 2009)
- HB4TH Medical Management of Chemical Casualties Handbook, 4<sup>th</sup> Edition
- HOPPENFELD, S. Physical Examination of the Spine and Extremities; Appleton-Century-Croft
- ISBN 0-07-065351- Emergency Medicine: A Comprehensive Study Guide by Judith E. Tintinalli, J. Stephan Stapczynski and Gabor D. Kelen 5<sup>th</sup> Edition, (Sep 30, 1999)
- ISBN 0-7216-6055-X Clinical Procedures in Emergency Medicine, Third Edition by James R. Roberts and Jerris R. Hedges (Jan 15, 1998)
- ISBN 0-7637-3563-9 Combat Medic Field Reference by United States Army (May 27, 2005)
- ISBN 0-7817-2296-9 The Lippincott Manual of Nursing Practice (7<sup>th</sup> Edition) by Sandra M. Nettina MSN ANP-BC (Nov 10, 2000)
- ISBN 0070663518 Emergency Medicine A Comprehensive Study Guide, 7<sup>th</sup> Edition (Book and DVD) (Emergency Medicine (Tintinalli) by Judith Tintinalli, J. Stapczynski, O. John Ma and David Cline (Oct 22, 2010)
- ISBN 0874934613 BLS for Healthcare Providers by Mary Fran Hazinski, Louis Gonzales and Lindy O'Neill (Jan 2005)
- ISBN 978-1-61669-039-7 American Heart Association, BLS for Healthcare Providers (Student Manual) by by Mary Fran Hazinski (Mar 1, 2011)
- KOZIER & ERB Techniques in Clinical Nursing: Basic to Intermediate Skills, (5<sup>th</sup> Edition) By Barbara J. Kozier, Audrey J. Berman, Glenora Erb and Shirlee Snyder (Jul 25, 2003)
- PAM 600-24 Health Promotion, Risk Reduction, and Suicide Prevention, 17 December 2009.
- STP 21-1-SMCT Soldier's Manual of Common Tasks (SMCT) Warrior Skills Level 1, September 11, 2012.
- STP 21-24-SMCT Soldier's Manual of Common Tasks (SMCT) Warrior Leader Skill Levels 2, 3, and 4, September 9, 2008.
- TM 1-1520-240-10 Operation's Manual for Army CH-47D Helicopter (EIC: RCD), 25 September 2009.
- TM 9-2355-311-10-1-1 Operator's Manual Volume 1 of 2 Common Items for Stryker Family of Vehicles, 16 November 2006.

### **Related Publications**

Related publications are sources of additional information. They are not required in order to understand this publication.

081-MEV1	Stryker Medical Evacuation Vehicle (MEV) Crew Training
FM 21-60	Visual Signals, 30 September 1987.
FM 3-21.8	The Infantry Rifle Platoon and Squad, 28 March 2007.
TM 1-1520-237-10	Operator's Manual for UH-60A Helicopter, UH-60L Helicopter, EH-60A Helicopter by US Army 25 September 2009.

**STP 8-68W13-SM-TG**  
**3 May 2013**

By Order of the Secretary of the Army:

**RAYMOND T. ODIERNO**  
*General, United States Army*  
*Chief of Staff*



**JOYCE E. MORROW**  
*Administrative Assistant to the*  
*Secretary of the Army*  
1309201

**DISTRIBUTION:**

*Active Army, Army National Guard, and US Army Reserve:* Not to be distributed. Electronic Media Only.

